

Sample Order / Cheat Sheet
N Window Hardware 1/2

QUOTE ORDER

NAME: _____
ADDRESS: _____
OFFICE PHONE: _____
FAX PHONE: _____
JOB PHONE: _____

PO# _____
DELIVERY: _____
ADDRESS: _____

ROCKY MOUNTAIN®
HARDWARE WORK ORDER
Toll Free 888.788.2013 or 208.788.2013; Fax 208.788.2577

ORDER DATE: _____
CONTACT: _____
JOB NAME: _____

2002.12.04

LINE NO.	FUNCTION	HANDLE		ESCUTCHEON		METAL	PATINA	HANDING OR LENGTH	BACKSET	DOOR THICKNESS	LOCK TYPE	DEAD BOLT TRIM	DESCRIPTION	LOCATION #	QTY.	PRICE QUOTED
		EXTERIOR	INTERIOR	EXTERIOR	INTERIOR											
1	WN	LW40		EW105		B	D	R		214					1	\$ 249
2	AC					B	L	R					WC200		1	\$ 222
3	AC					W	L						WC100		1	\$ 214
4	LC	LC300				W	D	R					LC305		1	\$ 367
5	AC					B	M						SL100		1	\$ 132

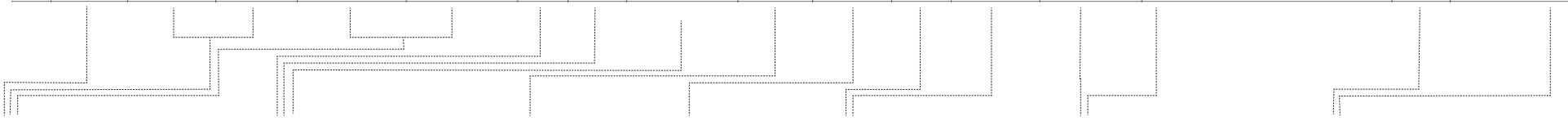

FUNCTION
AC = Accessory
CA = Casement Adjuster
LC = Casement Latch
WN = Window Trim Set

HANDLE
For a list of Levers available for Window Hardware, see next page.
For specifications, refer to Section A.

ESCUTCHEONS
For a list of Escutcheons available for Window Hardware, see next page.
For configurations, specifications, and pricing, refer to content of this section.

METAL
B = Silicon Bronze
W = White Bronze

PATINA
L = Light
M = Medium
D = Dark
R = Rust
BB = Brushed
DL = Dark Lustre
HP = High Polished *
*Up-charge applies.

HANDING / LENGTH
See Hinged Door Handing diagram, next page.
L = Left Hand
R = Right Hand
LR = Left Hand Reverse
RR = Right Hand Reverse

Casement Adjuster lengths:
10"
12"
14"
20"

BACKSET
Not Applicable

DOOR THICKNESS
138 = 13/8"
112 = 11/2"
134 = 13/4"
178 = 17/8"
2 = 2"
214 = 2 1/4"
212 = 2 1/2"
258 = 2 5/8"
234 = 2 3/4"
3 = 3"

Up-charge for sizes below.
Call for pricing.
314 = 3 1/4"
312 = 3 1/2"
4 = 4"
N = No

LOCK TYPE
Not Applicable

DEAD BOLT TRIM
Not Applicable

DESCRIPTION
For a list of available descriptions, see next page.

LOCATION #

QTY
Number of each desired

PRICE
\$ List price each

Sample Order / Cheat Sheet

N Window Hardware 2/2

HANDLES

LW05 = Mini Ellis Lever
 LW10 = Mini Euro Lever
 LW15 = Mini Legacy Lever
 LW20 = Mini French Lever
 LW23 = Mini Old World Lever
 LW33 = Mini Reed Lever
 LW37 = Mini Strap Lever
 LW40 = Mini Classic Lever
 LW50 = Mini Acanthus Lever
 LW60 = Mini Harrington Lever
 LW61 = Mini Rail Lever
 LW63 = Mini Olympus Lever
 LW65 = Mini Falcon Lever
 LW71 = Mini Coupler Lever
 LW80 = Mini Monarch Lever
 LW85 = Mini Ribbon & Reed Lever
 L104 = Hook Lever
 T300 = T Handle
 LC300 = Casement Latch Lever

ESCUTCHEONS**Arched**

EW720 = 13/16" x 3 3/4" Arched (WE)
 EW707 = 13/8" x 4 1/2" Arched (WE)
 EW705 = 1 1/2" x 3" Arched (WE)
 EW708 = 1 1/2" x 4 1/2" Arched (WE)

Convex

EW30500 = 1 1/2" x 3 3/4" Convex (WE)

Corbel Arched

EW30600 = 1 1/2" x 3 3/4" Corbel Arched (WE)

Corbel Rectangular

EW30700 = 1 1/2" x 3 3/4" Corbel Rect (WE)

Curved

EW507 = 1 1/4" x 4 1/2" Curved (WE)
 EW501 = 1 3/8" x 4 1/2" Curved (WE)
 EW508 = 1 1/2" x 4 1/2" Curved (WE)

Ellis

EW005 = 1 1/2" x 4 1/2" Ellis (WE)

Metro

EW225 = 1 1/4" x 4 1/2" Metro (WE)
 EW202 = 1 1/2" x 4 1/2" Metro (WE)

Rectangular

EW101 = 1 1/4" x 3" Rect (WE)
 EW103 = 1 3/8" x 4 1/2" Rect (WE)
 EW105 = 1 1/2" x 3" Rect (WE)
 EW108 = 1 1/2" x 4 1/2" Rect (WE)

Stepped

EW308 = 1 1/2" x 4 1/2" Stepped (WE)

Key

(WE) = Window Escutcheon

DESCRIPTION

LC303 = Mortise Strike
 LC305 = Universal Strike
 LC307 = Surface Strike
 SFP100 = Sash Lift
 SL100 = Sash Lock
 DHSL100 = Double-Hung Sash Lock
 DHSL200 = Double-Hung Sash Lock
 ULL200 = Sash Lock (Pella)
 LC500 = Sash Lock (Loewen)
 LC510 = Sash Lock (Truth)
 LC600 = Sash Lock (Truth)
 WC100 = Truth Window Crank & Cover
 WC140 = Marvin Window Crank & Cover
 WC141 = Marvin Window Crank & Cover
 WC160 = Truth Window Crank & Cover
 WC200 = Pella Window Crank & Cover
 WC400 = Marvin Window Crank & Cover
 WC450 = Truth Window Crank & Cover
 WL10 = Sash Lock (Marvin)
 WL180 = Sash Lock (Marvin)
 WL210 = Sash Lock (Marvin)
 WL211 = Sash Lock (Marvin Dummy)
 WD130 = Sash Lock (Marvin)
 WSL10 = Sash Lift (Marvin)
 WSL20 = Sash Lift (Marvin)
 WSL40 = Sash Lift (Marvin)

- Price includes your choice of any lever.
- Combinations are shown with L104 Hook Lever for illustrations only. Refer to Section A for desired lever.
- Specify metal, patina, sash thickness, handing, screws, spindle length, and type of window designed for.
- Supplied with M5 x .8 x 40 mm screws and 7 mm spindle unless otherwise specified.
- Levers index at 3, 6, 9, and 12 o'clock positions.

Window Trim Sets

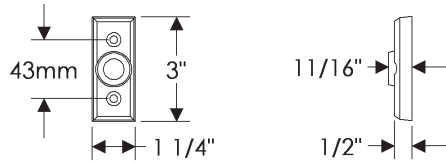

EW101 Rectangular Window Escutcheon

1 1/4" x 3"..... \$ 420

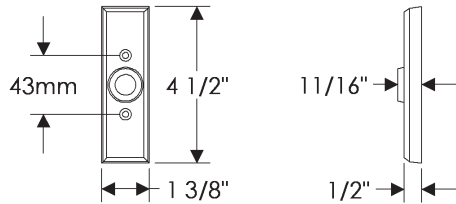

EW103 Rectangular Window Escutcheon

1 3/8" x 4 1/2"..... \$ 420

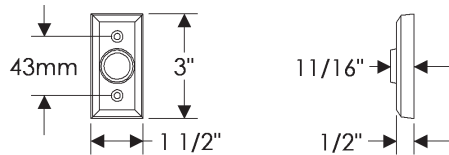

EW105 Rectangular Window Escutcheon

1 1/2" x 3"..... \$ 249

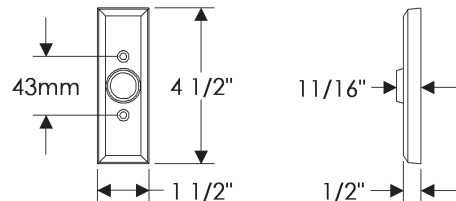
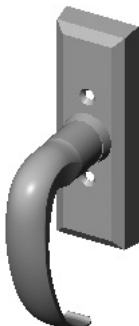

EW108 Rectangular Window Escutcheon

1 1/2" x 4 1/2"..... \$ 262

- Price includes your choice of any lever.
- Combinations are shown with L104 Hook Lever for illustrations only. Refer to Section A for desired lever.
- Specify metal, patina, sash thickness, handing, screws, spindle length, and type of window designed for.
- Supplied with M5 x .8 x 40 mm screws and 7 mm spindle unless otherwise specified.
- Levers index at 3, 6, 9, and 12 o'clock positions.

Window Trim Sets

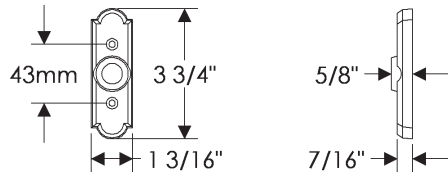

EW720 Arched Window Escutcheon
13/16" x 3 3/4" \$ 420

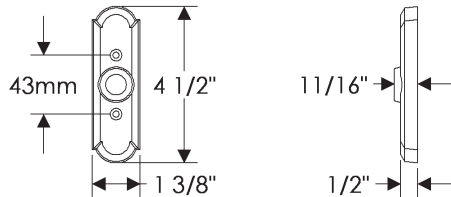

EW707 Arched Window Escutcheon
13/8" x 4 1/2" \$ 420

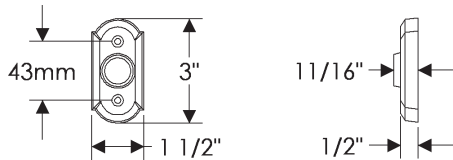

EW705 Arched Window Escutcheon
11/2" x 3" \$ 249

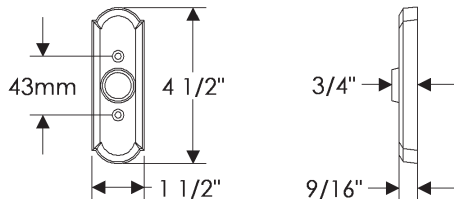
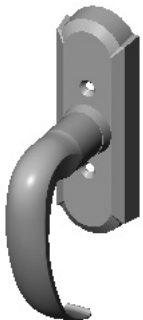

EW708 Arched Window Escutcheon
11/2" x 4 1/2" \$ 262

- Price includes your choice of any lever.
- Combinations are shown with L104 Hook Lever for illustrations only. Refer to Section A for desired lever.
- Specify metal, patina, sash thickness, handing, screws, spindle length, and type of window designed for.
- Supplied with M5 x .8 x 40 mm screws and 7 mm spindle unless otherwise specified.
- Levers index at 3, 6, 9, and 12 o'clock positions.

Window Trim Sets

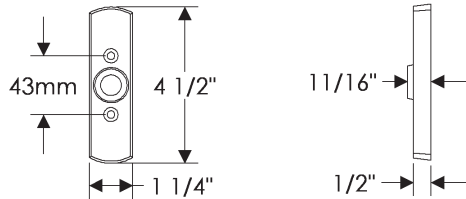

EW507 Curved Window Escutcheon
1 1/4" x 4 1/2" \$ 420

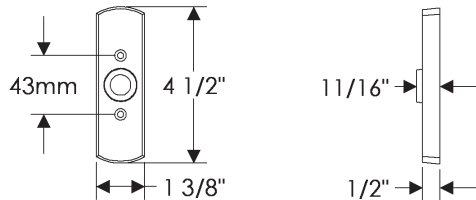

EW501 Curved Window Escutcheon
1 3/8" x 4 1/2" \$ 420

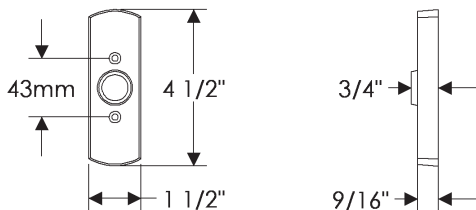

EW508 Curved Window Escutcheon
1 1/2" x 4 1/2" \$ 262

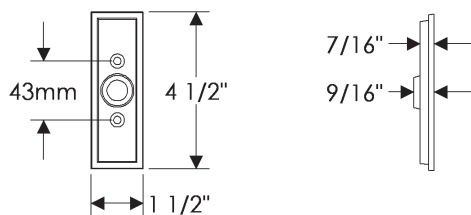

EW308 Stepped Window Escutcheon
1 1/2" x 4 1/2" \$ 420

- Price includes your choice of any lever.
- Combinations are shown with L104 Hook Lever for illustrations only. Refer to Section A for desired lever.
- Specify metal, patina, sash thickness, handing, screws, spindle length, and type of window designed for.
- Supplied with M5 x .8 x 40 mm screws and 7 mm spindle unless otherwise specified.
- Levers index at 3, 6, 9, and 12 o'clock positions.

Window Trim Sets

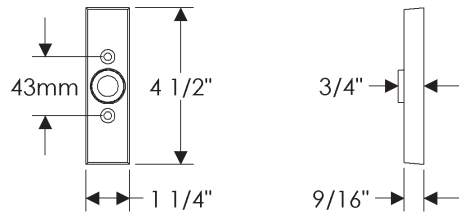

EW225 Metro Window Escutcheon
1 1/4" x 4 1/2" \$ 420

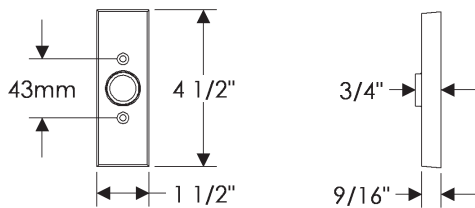

EW202 Metro Window Escutcheon
1 1/2" x 4 1/2" \$ 262

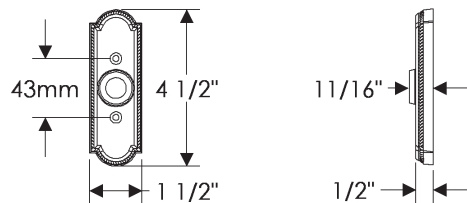

EW005 Ellis Window Escutcheon
1 1/2" x 4 1/2" \$ 454

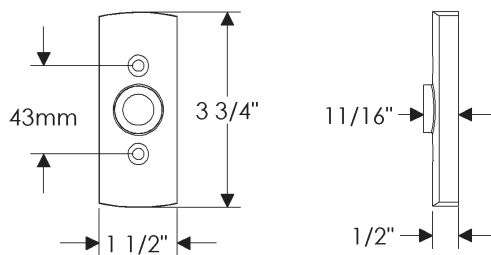

EW30500 Convex Window Escutcheon
1 1/2" x 3 3/4" \$ 454

- Price includes your choice of any lever.
- Combination is shown with L104 Hook Lever for illustrations only. Refer to Section A for desired lever.
- Specify metal, patina, sash thickness, handing, screws, spindle length, and type of window designed for.
- Supplied with M5 x .8 x 40 mm screws and 7 mm spindle unless otherwise specified.
- Levers index at 3, 6, 9, and 12 o'clock positions.

Window Trim Sets

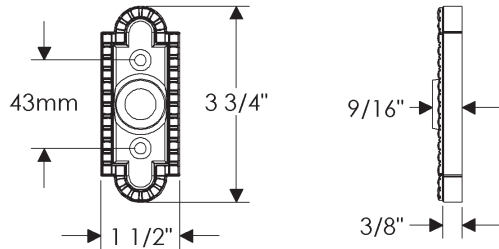

EW30600 Corbel Arched Window Escutcheon
 1 1/2" x 3 3/4"..... \$ 454

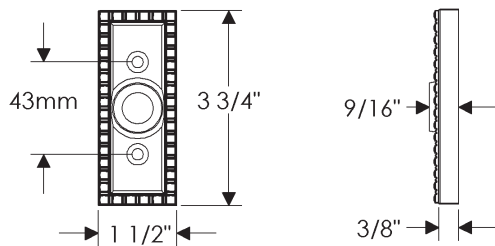

EW30700 Corbel Rectangular Window Escutcheon
 1 1/2" x 3 3/4"..... \$ 454

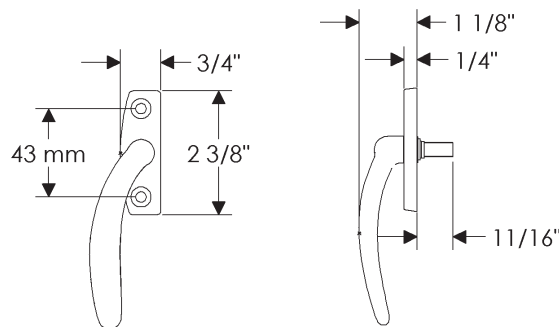
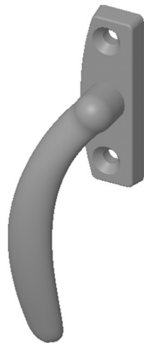

WL210 Sash Lock
 3/4" x 2 3/8"..... \$ 262

WL211 Sash Lock - Dummy
 3/4" x 2 3/8"..... \$ 262

* Designed for Marvin push out
 * Left hand shown - handing not typical to standard specifications

- Specify metal and patina (and handing for the WC140 and WC141 series).

Window Cranks

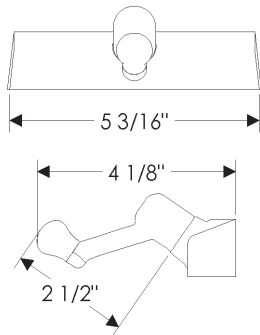
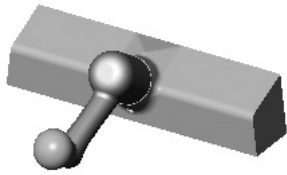

Casement Window Hardware*

WC100 Crank & Cover \$ 214

- * Designed for Truth Entry Guard.
- * Can be modified for compatibility with Ashland Mechanisms. Call for pricing.

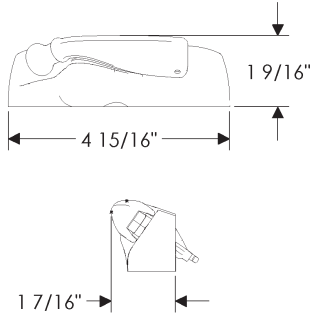
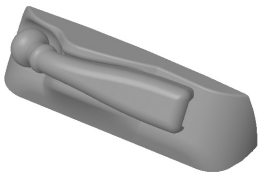

Casement Window Hardware*

WC140 Crank & Cover \$ 329

- * Designed for Marvin Ultimate Case Master
- * For handing examples, see image below.

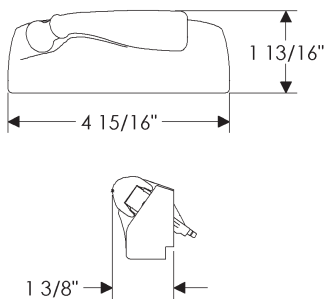
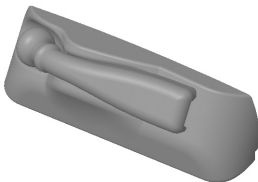

Casement Window Hardware*

WC141 Crank & Cover \$ 329

- * Designed for Marvin Ultimate Replacement Case Master
- * For handing examples, see image below.

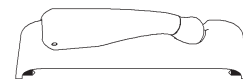

LEFT HAND COVER (L)



RIGHT HAND COVER (R)

- Specify metal, patina, and handing.

Window Cranks

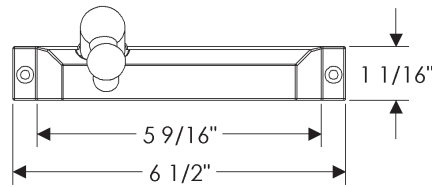
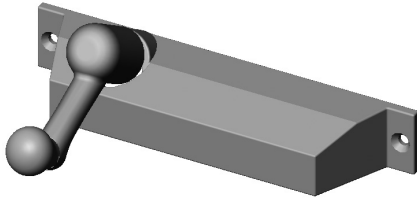

Casement Window Hardware*

WC160 Crank & Cover \$ 222

* Specify Truth Encore or Truth Maxim

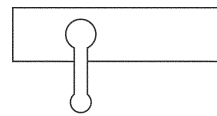

LEFT HAND WINDOW (L)

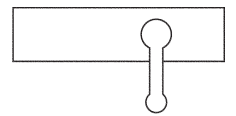

RIGHT HAND WINDOW (R)

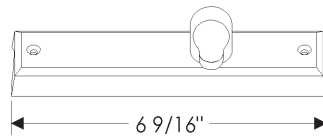
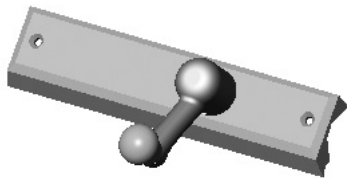
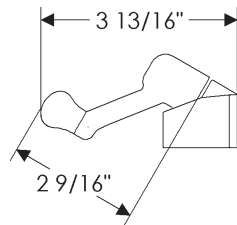

Casement Window Hardware*

WC200 Crank & Cover \$ 222

* Designed for Pella Architect and Designer Series models.

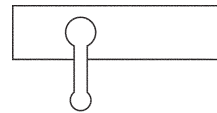

LEFT HAND WINDOW (L)

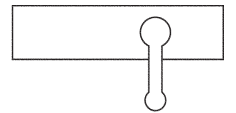

RIGHT HAND WINDOW (R)

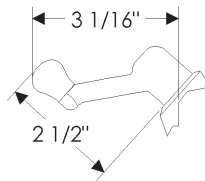

- Specify metal, patina, and handing.

Window Cranks

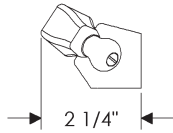
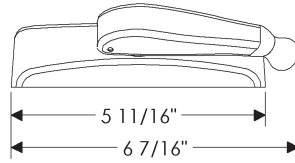
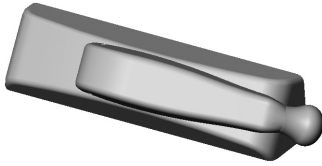

Casement Window Hardware*

WC400 Crank & Cover \$ 329

- * Designed for Truth Entry Guard.
- * Can be modified for compatibility with Ashland Mechanisms. Call for pricing.

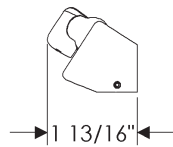
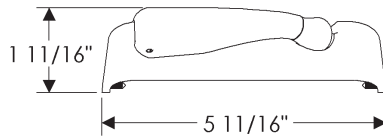
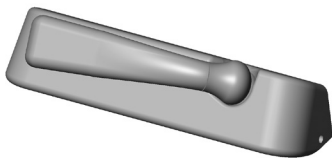

Casement Window Hardware*

WC450 Crank & Cover \$ 329

- * Designed for Truth Encore.
- * For most situations a left hand cover will work with a left hand window. Narrow windows may be an exception. Verify cover handing with images below.
- * For handing examples, see image below.

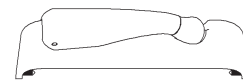

LEFT HAND COVER (L)

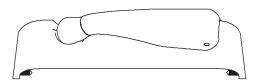

RIGHT HAND COVER (R)

- Specify metal, patina, and handing.

Casement Latches

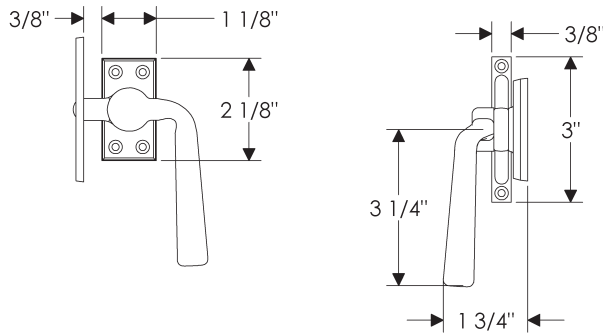
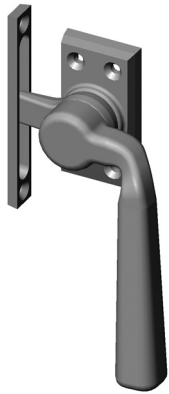

**LC300 Casement Latch
with LC303 Mortise Strike..... \$ 350**

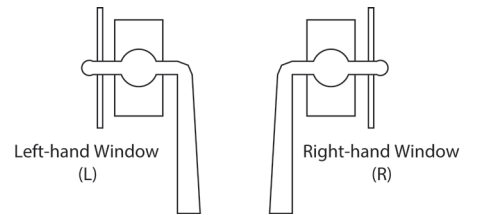

- Optional strike: LC307

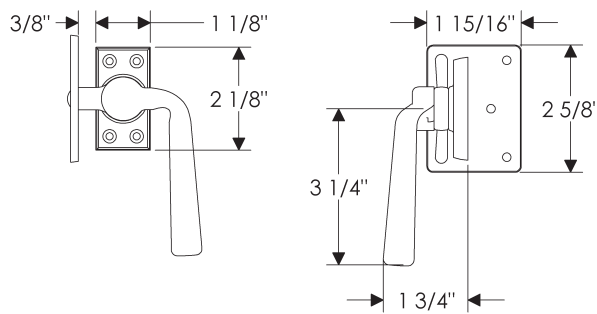
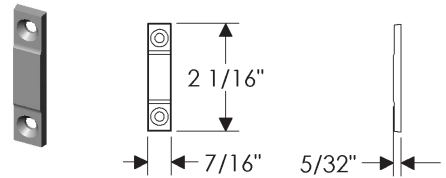

**LC300 Casement Latch
with LC305 Universal Strike..... \$ 367**

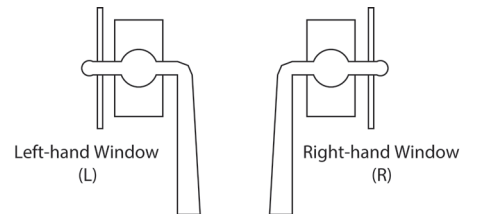

- Optional strike: LC307

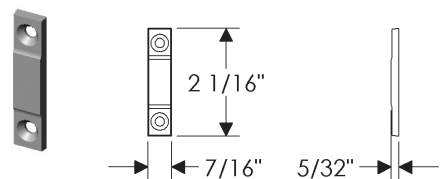

- Specify metal and patina (and handing for the ULL200 Sash Lock).

Sash Lifts

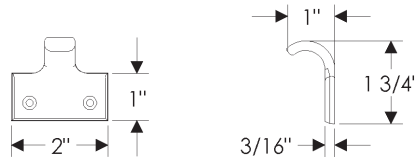
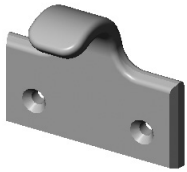

SFP100 Sash Lift..... \$ 58

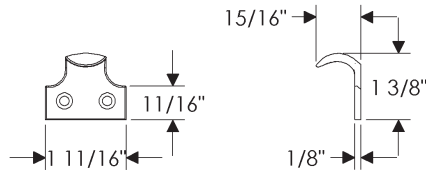

WSL20 Sash Lift \$ 53

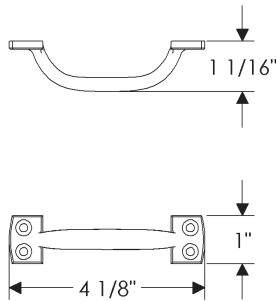

WSL10 Double-Hung Sash Lift \$ 68

* Compatible with Marvin Ultimate double hung.

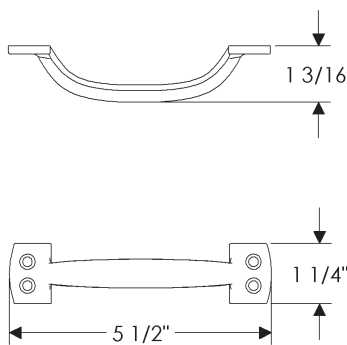
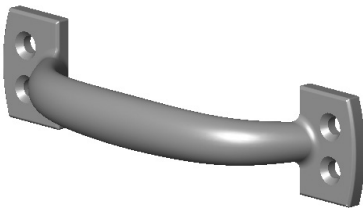

WSL40 Double-Hung Sash Lift..... \$ 115

* Compatible with Marvin Ultimate double hung magnum.

- Specify metal and patina (and handing for the ULL200 Sash Lock).

Sash Locks

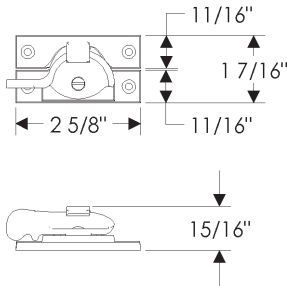
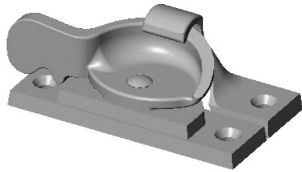

SL100 Sash Lock \$ 132

- Shown with strike: SLK100
- Optional strike: SLK105

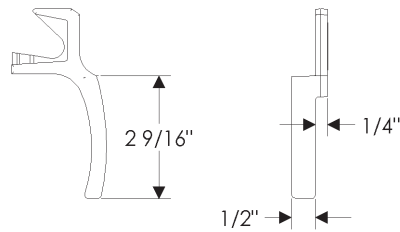
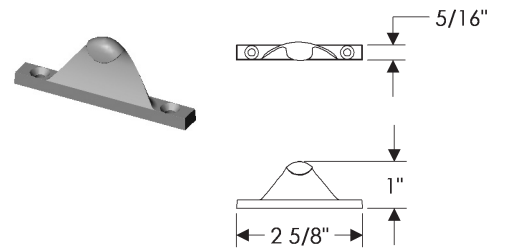

ULL200 Sash Lock* \$ 66

- * Designed for Pella windows.
Call for compatibility.

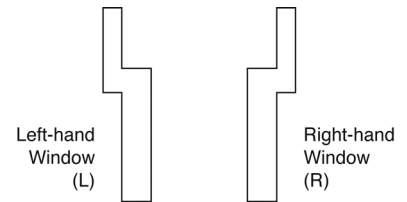

- Specify metal and patina.

Sash Locks

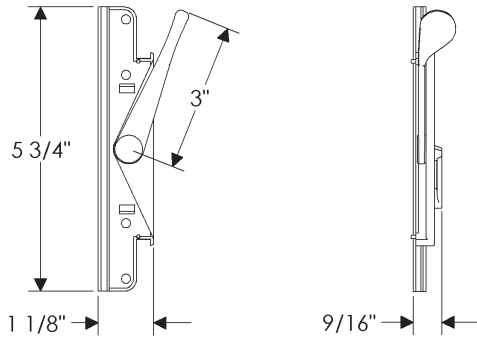
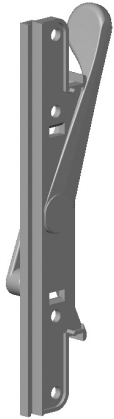

WL10 Sash Lock* \$ 281

* Designed for Marvin Casemaster windows.
Call for compatibility.

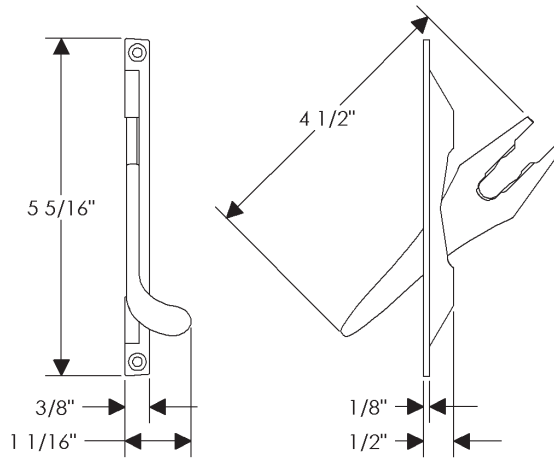
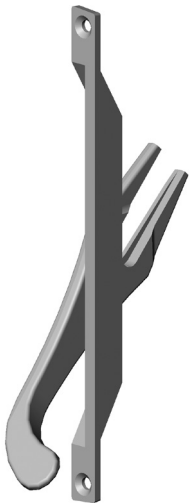

LC500 Sash Lock* \$ 371

* Designed for Truth Mirage Concealed
Multi-point Locking Systems.

- Specify metal and patina.

Sash Locks

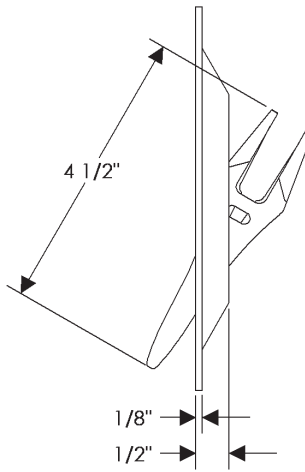
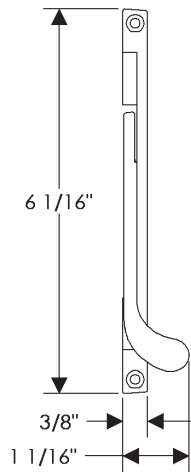

LC510 Sash Lock* \$ 371

* Designed for Ashland Multi-point Casement Locks.

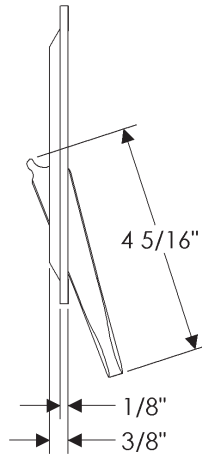
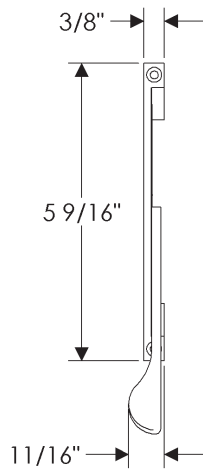

LC600 Sash Lock* \$ 371

* Designed for Truth Encore Multi-point Casement Locks.

* Field modifications required, call for specifications.

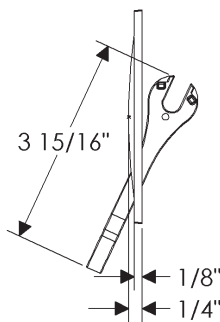
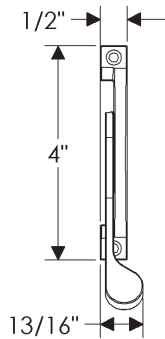

WL180 Sash Lock* \$ 371

* Designed for Marvin Ultimate Casemaster.

- Specify metal and patina.

Double-Hung Sash Lock

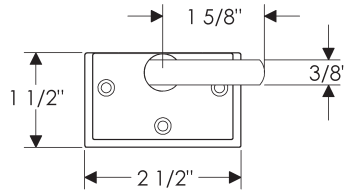
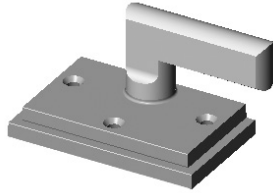

DHSL100 Double-Hung Sash Lock \$ 178

- Compatible with Pella Model 2 Architect series windows
- Includes strike (not pictured)

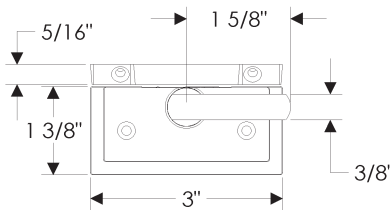
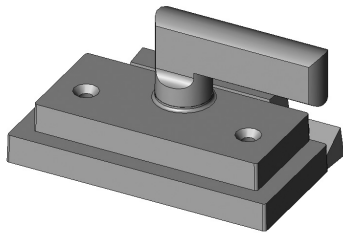
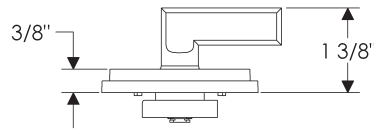

DHSL200 Double-Hung Sash Lock \$ 242

- Compatible with Pella Model 3 Architect series windows
- Includes bronze strike

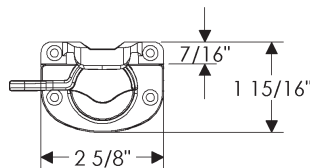
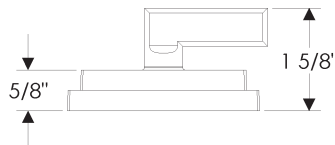

WD130 Double-Hung Sash Lock \$ 286

- Compatible with Marvin Ultimate double hung magnum

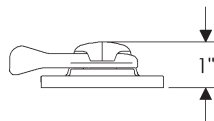

- Specify metal and patina.

Casement Adjusters

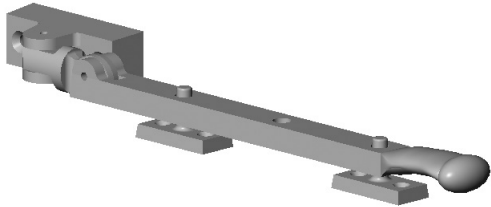

CA10 Casement Adjuster \$ 390

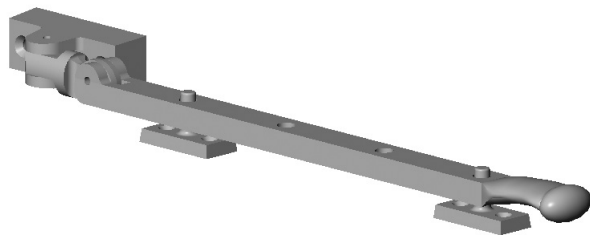
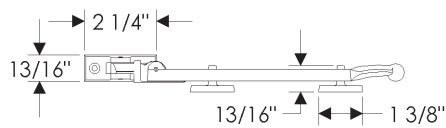
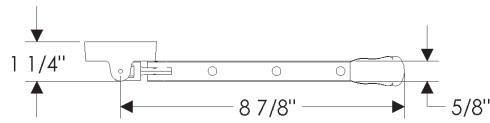

CA12 Casement Adjuster \$ 394

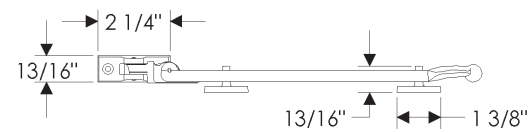
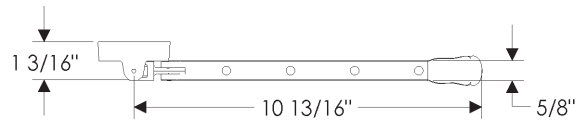

- Specify metal and patina.

Casement Adjusters

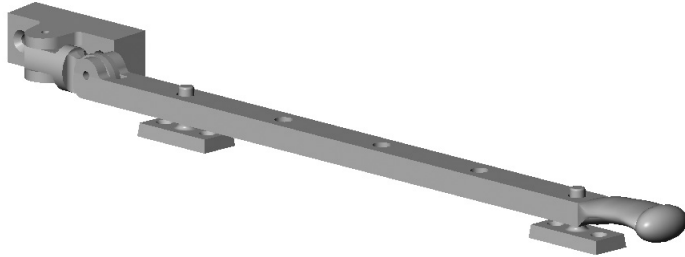

CA14 Casement Adjuster \$ 400

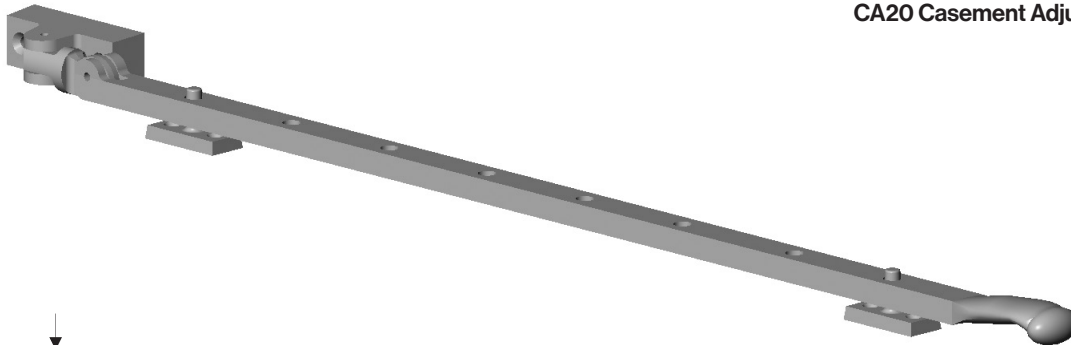
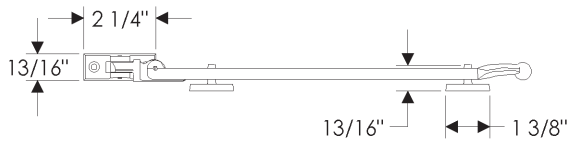
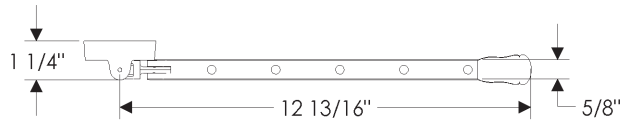

CA20 Casement Adjuster \$ 462

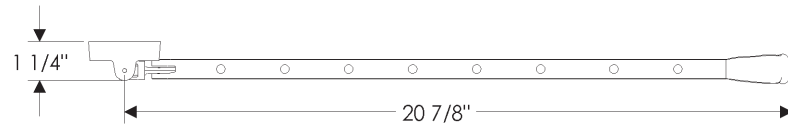



1020 Airport Way Hailey, Idaho 83333 USA
toll free 888.788.2013 • ph. 208.788.2013 • fax 208.788.2577
info@rockymountainhardware.com
www.rockymountainhardware.com