

Sample Order / Cheat Sheet
I Sliding Door Sets 1/3

QUOTE ORDER

NAME: _____

PO# _____

ADDRESS: _____

DELIVERY: _____



ORDER DATE: _____

OFFICE PHONE: _____

CONTACT: _____

FAX PHONE: _____

JOB NAME: _____

JOB PHONE: _____

Toll Free 888.788.2013 or 208.788.2013; Fax 208.788.2577

2002.12.04

LINE NO.	FUNCTION	HANDLE		ESCUTCHEON		METAL	PATINA	HANDING OR LENGTH	BACKSET	DOOR THICKNESS	LOCK TYPE	DEAD BOLT TRIM	DESCRIPTION	LOCATION #	QTY.	PRICE QUOTED
		EXTERIOR	INTERIOR	EXTERIOR	INTERIOR											
1	SLPO	SDP6	SDP6	E468	E469	B	L	OX	N	134	AM			26	1	\$ 762
2	SLEN	L124	L124	E333	E333	W	D	XO	N	134	PR		122mm	30	1	\$ 1095
3	SDL					B	D	D	212	134	PO		FP258		1	\$ 1403
4	PDL					B	M			134			FP210		1	\$ 693
5	AC					B	M						FP208		2	\$ 142
6	AC					B	M						EP100		1	\$ 99
7	AC					W	L						BF100		1	\$ 440

FUNCTION

- AC = Accessory
- PDPA = Pocket Door Passage
- PDL = Pocket Door Lock
- SDL = Sliding Door Lock
- SLEN = Sliding Door Entry
- SLPO = Sliding Door Patio
- SLDU = Dummy
- LS = Lift & Slide

HANDLE

For a list of Grips and Flush Pulls available for Sliding Door Sets and Hardware, see next page.

For specifications, refer to Section A.

ESCUTCHEONS

For a list of Escutcheons available for Sliding Door Sets, see next page.

For configurations, specifications, and pricing, refer to content of this section.

METAL

- B = Silicon Bronze
- W = White Bronze

PATINA

- L = Light
- M = Medium
- D = Dark
- R = Rust
- BB = Brushed
- DL = Dark Lustré
- HP = High Polished *
- *Up-charge applies.

HANDING

See Sliding Door Handing diagram, next page.

- OX
- XO
- OXO
- OXXO
- S = Single Door
- D = Double Door

BACKSET

- 238 = 2 3/8"
- 212 = 2 1/2"
- 234 = 2 3/4"

PATINA

- Up-charge for sizes below.
- Call for pricing.
- 114 = 1 1/4"
- 112 = 1 1/2"
- 134 = 1 3/4"
- 2 = 2"
- 214 = 2 1/4"
- 334 = 3 3/4"
- 5 = 5"
- 6 = 6"
- N = No

DOOR THICKNESS

- 138 = 13/8"
- 112 = 1 1/2"
- 134 = 1 3/4"
- 178 = 1 7/8"
- 2 = 2"
- 214 = 2 1/4"

DOOR THICKNESS

- Up-charge for sizes below.
- Call for pricing.
- 212 = 2 1/2"
- 258 = 2 5/8"
- 234 = 2 3/4"
- 3 = 3"
- 314 = 3 1/4"
- 312 = 3 1/2"
- 4 = 4"
- N = No

LOCK TYPE

- Complete Sets**
- PO = Patio Function
- PR = Privacy Function
- EN = Entry Function
- AM = American Cylinder
- PR = Profile Cylinder

DEAD BOLT TRIM

Not Applicable

DESCRIPTION

Center to Center dimension

Edge Pulls
 EP100 = 1" x 4 1/2" Edge Pull

Slide Folds
 BF100 = 11/8" x 2 3/4"

Flush Pulls
 See page liii for Flush Pulls available for Sliding Door Sets.

Edge Collection Options

- ETW = Weave
- EWD = Wood
- EBA = Basic
- ETD = Tide
- EWR = Wire
- EMS = Mooncape

LOCATION #

Room Number or Door Number, etc.

QTY

Number of each desired

PRICE

\$ List price each

Sample Order / Cheat Sheet

I Sliding Door Sets 2/3

HANDLE

Grips

- G258 = 6" Offset Rail Grip
- G260 = 6" Offset Curved Rail Grip
- G645 = 6" Offset Olympus Pull
- G830 = Low-Projection Sliding Door Grip
- G10810 = 6" Offset Briggs Grip
- G30168 = 8" Pillar Grip
- G30188 = 8" Cabernet Grip
- G30300 = 6" Offset Trousdale Grip
- SDP6 = 6" Offset D Grip
- SDT6 = 6" Offset Branch Grip

Levers

Multi-Point Sliding Door

- L124 = Offset Lever
- L177 = Offset Tube Lever

Lift & Slide

- L114 = Long Hook Lever
- L134 = Long Reed Lever
- L138 = Long Monarch Lever
- L139 = Long Old World Lever
- L142 = Long Legacy Lever
- L144 = Extra Long Hook Lever
- L145 = Long Olympus Lever
- L146 = Long Triple Twist Lever
- L148 = Long French Lever
- L149 = Long Jane Lever
- L157 = Long Stalk Lever
- L167 = Long Bamboo Lever
- L168 = Long Twig Lever
- L172 = Long Acanthus Lever
- L173 = Long Lariat Lever
- L176 = Long Rock Creek Lever
- L180 = Long Harrington Lever
- L264 = Long Trolley Lever
- L266 = Long I Beam Lever
- L331 = Long Coupler Lever
- L332 = Long Blade Lever
- L10804 = Long Briggs Lever
- L21075 = Long Emile Lever
- L30145 = Long Smith Lever

ESCUICHEONS

Arched

- E708 = 13/8" x 11" Arched (GCtr)
- E709 = 13/8" x 11" Arched (GCtr)(TP)
- E715 = 13/8" x 11" Arched (GLo)
- E714 = 13/8" x 11" Arched (GLo)(AM)
- E717 = 13/8" x 11" Arched (GLo)(TP)
- E718 = 13/8" x 11" Arched (Lvr)
- E720 = 13/8" x 11" Arched (Lvr)(PR)

- E760 = 13/4" x 11" Arched (GCtr)
- E762 = 13/4" x 11" Arched (GCtr)(TP)
- E746 = 13/4" x 11" Arched (Lvr)

Arched (continued)

- E740 = 13/4" x 11" Arched (Lvr)(PR)
- E746 = 13/4" x 11" Arched (LS)
- E796 = 13/4" x 13" Arched (GLo)
- E798 = 13/4" x 13" Arched (GLo)(AM)
- E797 = 13/4" x 13" Arched (GLo)(TP)
- E790 = 2 1/2" x 13" Arched (GLo)
- E791 = 2 1/2" x 13" Arched (GLo)(TP)
- E793 = 2 1/2" x 13" Arched (GLo)
- E794 = 2 1/2" x 13" Arched (GLo)(TP)

Bordeaux

- E30870 = 1 1/4" x 14 11/16" Bordeaux (GCtr)
- E30871 = 1 1/4" x 14 11/16" Bordeaux (GCtr)(TP)
- E30872 = 1 1/4" x 17 11/16" Bordeaux (GCtr)
- E30873 = 1 1/4" x 17 11/16" Bordeaux (GCtr)(TP)
- E30874 = 1 1/4" x 17 11/16" Bordeaux (GLo)
- E30876 = 1 1/4" x 17 11/16" Bordeaux (GLo)(AM)
- E30875 = 1 1/4" x 17 11/16" Bordeaux (GLo)(TP)

- E30880 = 2" x 18 7/8" Bordeaux (GCtr)
- E30881 = 2" x 18 7/8" Bordeaux (GCtr)(TP)
- E30882 = 2" x 18 7/8" Bordeaux (GLo)
- E30884 = 2" x 18 7/8" Bordeaux (GLo)(AM)
- E30883 = 2" x 18 7/8" Bordeaux (GLo)(TP)

Briggs

- E10879 = 2" x 15" Briggs (GCtr)
- E10880 = 2" x 15" Briggs (GCtr)(TP)
- E10883 = 2" x 15" Briggs (GLo)
- E10881 = 2" x 15" Briggs (GLo)(AM)
- E10882 = 2" x 15" Briggs (GLo)(TP)
- E10871 = 2" x 15" Briggs (Lvr)
- E10885 = 2" x 15" Briggs (Lvr)(PR)

Convex

- E30565 = 13/4" x 11" Convex (Lvr)
- E30569 = 13/4" x 11" Convex (Lvr)(PR)
- E30582 = 1 1/4" x 14" Convex (GLo)
- E30584 = 1 1/4" x 14" Convex (GLo)(AM)
- E30583 = 1 1/4" x 14" Convex (GLo)(TP)

Corbel Arched

- E30665 = 2" x 11" Corbel (Lvr)
- E30669 = 2" x 11" Corbel (Lvr)(PR)
- E30665 = 2" x 11" Corbel (LS)
- E30680 = 2" x 14" Corbel (GCtr)
- E30681 = 2" x 14" Corbel (GCtr)(TP)
- E30682 = 2" x 14" Corbel (GLo)
- E30684 = 2" x 14" Corbel (GLo)(AM)
- E30683 = 2" x 14" Corbel (GLo)(TP)

Corbel Rectangular

- E30765 = 2" x 11" Corbel (Lvr)
- E30769 = 2" x 11" Corbel (Lvr)(PR)
- E30765 = 2" x 11" Corbel (LS)

Corbel Rectangular (continued)

- E30780 = 2" x 14" Corbel (GCtr)
- E30781 = 2" x 14" Corbel (GCtr)(TP)
- E30782 = 2" x 14" Corbel (GLo)
- E30784 = 2" x 14" Corbel (GLo)(AM)
- E30783 = 2" x 14" Corbel (GLo)(TP)

Curved

- E518 = 13/8" x 11" Curved (GCtr)
- E519 = 13/8" x 11" Curved (GCtr)(TP)
- E520 = 13/8" x 11" Curved (GLo)
- E526 = 13/8" x 11" Curved (GLo)(AM)
- E521 = 13/8" x 11" Curved (GLo)(TP)
- E576 = 13/8" x 11" Curved (Lvr)
- E564 = 13/8" x 11" Curved (Lvr)(PR)

- E551 = 13/4" x 11" Curved (GCtr)
- E552 = 13/4" x 11" Curved (GCtr)(TP)
- E530 = 13/4" x 11" Curved (Lvr)
- E533 = 13/4" x 11" Curved (Lvr)(PR)
- E530 = 13/4" x 11" Curved (LS)

- E561 = 13/4" x 13" Curved (GLo)
- E563 = 13/4" x 13" Curved (GLo)(AM)
- E562 = 13/4" x 13" Curved (GLo)(TP)

Edge

- E185 = 13/4" x 13" Edge (GCtr)
- E186 = 13/4" x 13" Edge (GCtr)(TP)
- E187 = 13/4" x 13" Edge (GLo)
- E189 = 13/4" x 13" Edge (GLo)(AM)
- E188 = 13/4" x 13" Edge (GLo)(TP)
- E195 = 13/4" x 11" Edge (Lvr)
- E199 = 13/4" x 11" Edge (Lvr)(PR)
- E193 = 13/4" x 11" Edge (LS)

Ellis

- E027 = 13/4" x 11" Ellis (GCtr)
- E028 = 13/4" x 11" Ellis (GCtr)(TP)
- E021 = 13/4" x 11" Ellis (GLo)
- E023 = 13/4" x 11" Ellis (GLo)(AM)
- E022 = 13/4" x 11" Ellis (GLo)(TP)
- E041 = 13/4" x 11" Ellis (Lvr)
- E048 = 13/4" x 11" Ellis (Lvr)(PR)
- E041 = 13/4" x 11" Ellis (LS)

Hammered

- E30480 = 13/4" x 13" Hammered (GCtr)
- E30481 = 13/4" x 13" Hammered (GCtr)(TP)
- E30482 = 13/4" x 13" Hammered (GLo)
- E30484 = 13/4" x 13" Hammered (GLo)(AM)
- E30483 = 13/4" x 13" Hammered (GLo)(TP)

Mack

- E21041 = 13/4" x 11" Mack (Lvr)
- E21048 = 13/4" x 11" Mack (Lvr)(PR)
- E21041 = 13/4" x 11" Mack (LS)

Mack (continued)

- E21027 = 13/4" x 13" Mack (GCtr)
- E21028 = 13/4" x 13" Mack (GCtr)(TP)
- E21021 = 13/4" x 13" Mack (GLo)
- E21023 = 13/4" x 13" Mack (GLo)(AM)
- E21022 = 13/4" x 13" Mack (GLo)(TP)

Maddox

- E598 = 13/4" x 11" Maddox (GCtr)
- E599 = 13/4" x 11" Maddox (GCtr)(TP)
- E591 = 13/4" x 11" Maddox (Lvr)
- E593 = 13/4" x 11" Maddox (Lvr)(PR)
- E591 = 13/4" x 11" Maddox (LS)

Metro

- E218 = 13/8" x 11" Metro (GCtr)
- E219 = 13/8" x 11" Metro (GCtr)(TP)
- E220 = 13/8" x 11" Metro (GLo)
- E235 = 13/8" x 11" Metro (GLo)(AM)
- E234 = 13/8" x 11" Metro (GLo)(TP)
- E270 = 13/8" x 11" Metro (Lvr)
- E275 = 13/8" x 11" Metro (Lvr)(PR)
- E277 = 13/8" x 13" Metro (GLo)
- E278 = 13/8" x 13" Metro (GLo)(TP)
- E279 = 13/8" x 13" Metro (GLo)(AM)

- E227 = 13/4" x 11" Metro (GCtr)
- E228 = 13/4" x 11" Metro (GCtr)(TP)
- E221 = 13/4" x 11" Metro (GLo)
- E223 = 13/4" x 11" Metro (GLo)(AM)
- E222 = 13/4" x 11" Metro (GLo)(TP)
- E241 = 13/4" x 11" Metro (Lvr)
- E248 = 13/4" x 11" Metro (Lvr)(PR)
- E241 = 13/4" x 11" Metro (LS)
- E224 = 13/4" x 13" Metro (GLo)
- E226 = 13/4" x 13" Metro (GLo)(AM)
- E225 = 13/4" x 13" Metro (GLo)(TP)

(Escutcheons continued on next page)

Key

- (AM) = American Cylinder Escutcheon
- (GCtr) = Grip Centered
- (GLo) = Grip Low
- (LS) = Lift & Slide Escutcheon
- (Lvr) = Lever
- (PR) = Profile Cylinder Escutcheon
- (TP) = Turn Piece Escutcheon

Sample Order / Cheat Sheet

I Sliding Door Sets 3/3

ESCUTCHEONS (continued)

- Rectangular**
 E468 = 13/8" x 11" Rect (GCtr)
 E469 = 13/8" x 11" Rect (GCtr)(TP)
 E484 = 13/8" x 11" Rect (GLo)
 E485 = 13/8" x 11" Rect (GLo)(AM)
 E482 = 13/8" x 11" Rect (GLo)(TP)
 E456 = 13/8" x 11" Rect (Lvr)
 E440 = 13/8" x 11" Rect (Lvr)(PR)
 E444 = 13/4" x 11" Rect (GCtr)
 E466 = 13/4" x 11" Rect (GCtr)(TP)
 E446 = 13/4" x 11" Rect (Lvr)
 E449 = 13/4" x 11" Rect (Lvr)(PR)
 E446 = 13/4" x 11" Rect (LS)
 E496 = 13/4" x 13" Rect (GLo)
 E498 = 13/4" x 13" Rect (GLo)(AM)
 E497 = 13/4" x 13" Rect (GLo)(TP)
 E490 = 2 1/2" x 13" Rect (GLo)
 E491 = 2 1/2" x 13" Rect (GLo)(TP)
 E493 = 2 1/2" x 13" Rect (GLo)
 E494 = 2 1/2" x 13" Rect (GLo)(TP)

Stepped

- E318 = 13/8" x 11" Stepped (GCtr)
 E319 = 13/8" x 11" Stepped (GCtr)(TP)
 E320 = 13/8" x 11" Stepped (GLo)
 E326 = 13/8" x 11" Stepped (GLo)(AM)
 E321 = 13/8" x 11" Stepped (GLo)(TP)
 E376 = 13/8" x 11" Stepped (Lvr)
 E374 = 13/8" x 11" Stepped (Lvr)(PR)
 E370 = 13/8" x 13" Stepped (GLo)
 E372 = 13/8" x 13" Stepped (GLo)(AM)
 E371 = 13/8" x 13" Stepped (GLo)(TP)
 E351 = 13/4" x 11" Stepped (GCtr)
 E352 = 13/4" x 11" Stepped (GCtr)(TP)
 E330 = 13/4" x 11" Stepped (Lvr)
 E333 = 13/4" x 11" Stepped (Lvr)(PR)
 E330 = 13/4" x 11" Stepped (LS)
 E341 = 13/4" x 13" Stepped (GLo)
 E343 = 13/4" x 13" Stepped (GLo)(AM)
 E342 = 13/4" x 13" Stepped (GLo)(TP)

Trousdale

- E30365 = 13/4" x 11" Trousdale (Lvr)
 E30369 = 13/4" x 11" Trousdale (Lvr)(PR)
 E30363 = 13/4" x 11" Trousdale (LS)
 E30380 = 13/4" x 13" Trousdale (GCtr)
 E30381 = 13/4" x 13" Trousdale (GCtr)(TP)
 E30382 = 13/4" x 13" Trousdale (GLo)
 E30384 = 13/4" x 13" Trousdale (GLo)(AM)
 E30383 = 13/4" x 13" Trousdale (GLo)(TP)

Flush Pulls

- FP025 = 2 1/2" x 11" Ellis
 FP105 = 2 3/4" x 8" Designer
 FP204 = 2" x 4 1/4" Rect
 FP206 = 2 1/4" x 6" Rect
 FP208 = 2 1/2" x 8" Rect
 FP209 = 1 3/4" x 9" Rect
 FP210 = 2 1/2" x 10" Rect
 FP212 = 1 3/4" x 12" Rect
 FP216 = 1 3/4" x 6" Rect
 FP217 = 1 3/4" x 20" Rect
 FP218 = 2" x 8" Rect
 FP219 = 2 11/16" x 20" Rect
 FP224 = 1 3/8" x 4 5/16" Curved
 FP249 = 2 1/2" x 9" Curved
 FP251 = 2" x 22" Rect
 FP252 = 2 1/2" x 12" Curved
 FP253 = 2 1/2" x 11" Arched
 FP254 = 2" x 16 3/8" Rect
 FP255 = 2 1/2" x 12 1/4" Arched
 FP256 = 2" x 11" Rect
 FP258 = 2 1/2" x 8 1/2" Rect
 FP259 = 2 1/2" x 9" Arched
 FP260 = 2 1/2" x 11" Rect
 FP262 = 2 1/2" x 13" Rect
 FP264 = 2 1/4" x 22" Rect
 FP268 = 2 1/2" x 10" Rect
 FP269 = 2 1/2" x 9" Arched
 FP270 = 2 1/2" x 11" Arched
 FP308 = 2 1/2" x 8" Rect
 FP359 = 3 3/4" x 9" Diamond
 FP410 = 4" x 10" Flush Pull w/ Cover
 FP512 = 3" x 12 1/2" Maddox
 FP1349 = 1 3/4" x 9" Arched
 FP10010 = 3" x 10" Paris
 FP30600 = 2 1/2" x 9" Corbel Arched
 FP30700 = 2 1/2" x 8 1/2" Corbel Rectangular

Key

- (AM) = American Cylinder Escutcheon
 (GCtr) = Grip Centered
 (GLo) = Grip Low
 (LS) = Lift & Slide Escutcheon
 (Lvr) = Lever
 (PR) = Profile Cylinder Escutcheon
 (TP) = Turn Piece Escutcheon

HANDING

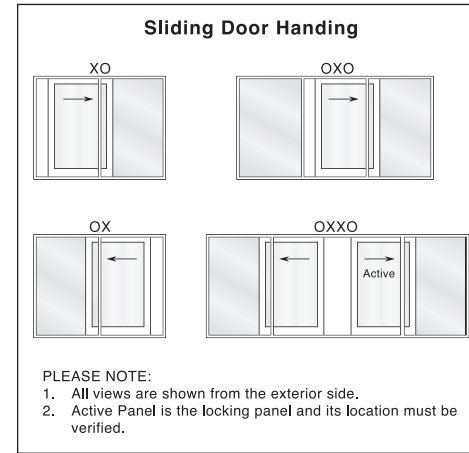

Patio Sliding Door Set

- 1 Escutcheon
- 2 Grip
- 3 Turn Piece
- 4 Sex Bolt
- 5 Sex Bolt Machine Screw

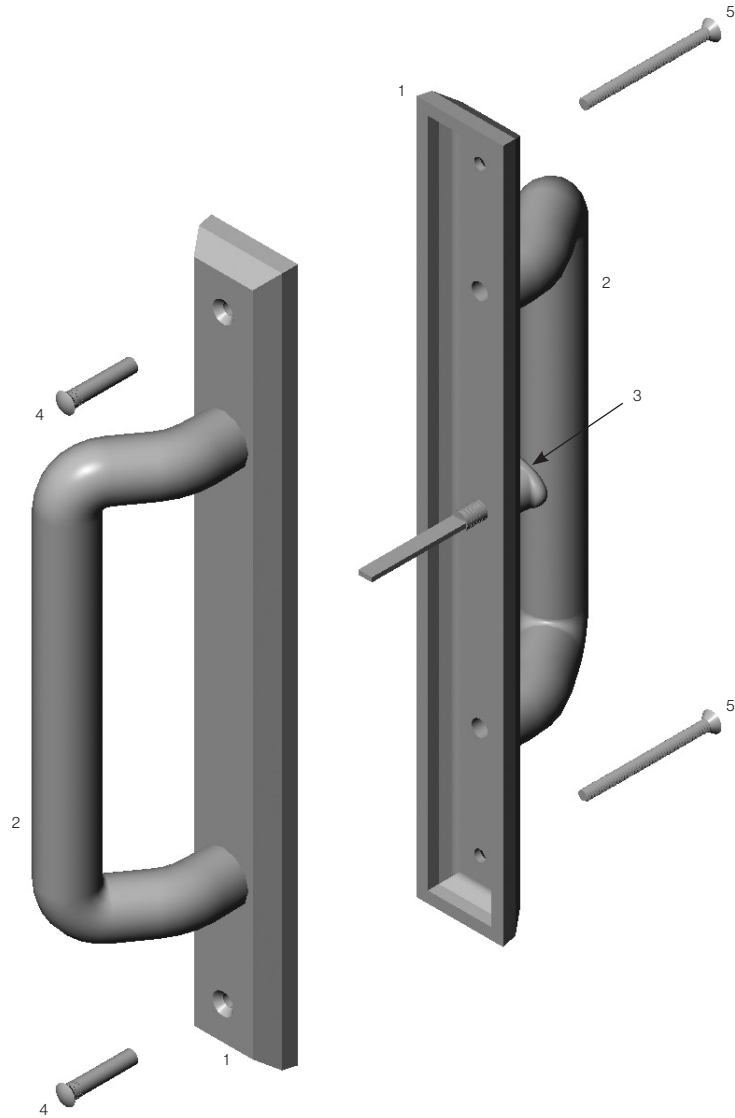

Entry Sliding Door Set

- 1 Escutcheon
- 2 Grip
- 3 Turn Piece
- 4 American Cylinder
- 5 Sex Bolt Machine Screw
- 6 Sex Bolt
- 7 Tail Piece

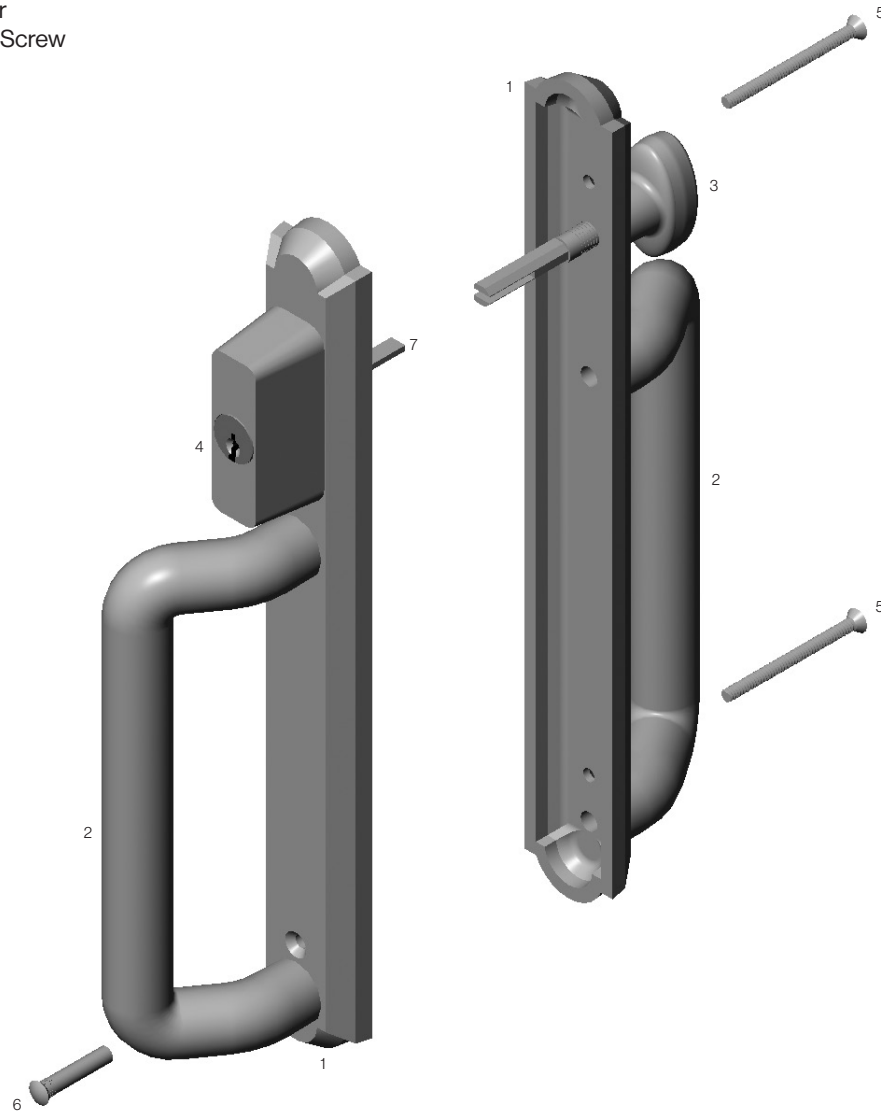

Entry Sliding Door Lock

- 1 Flush Pull
- 2 Mortise Cylinder
- 3 Turn Piece
- 4 Sliding Door Lock
- 5 Scalp
- 6 Sliding Door Lock Strike
- 7 Dust Box

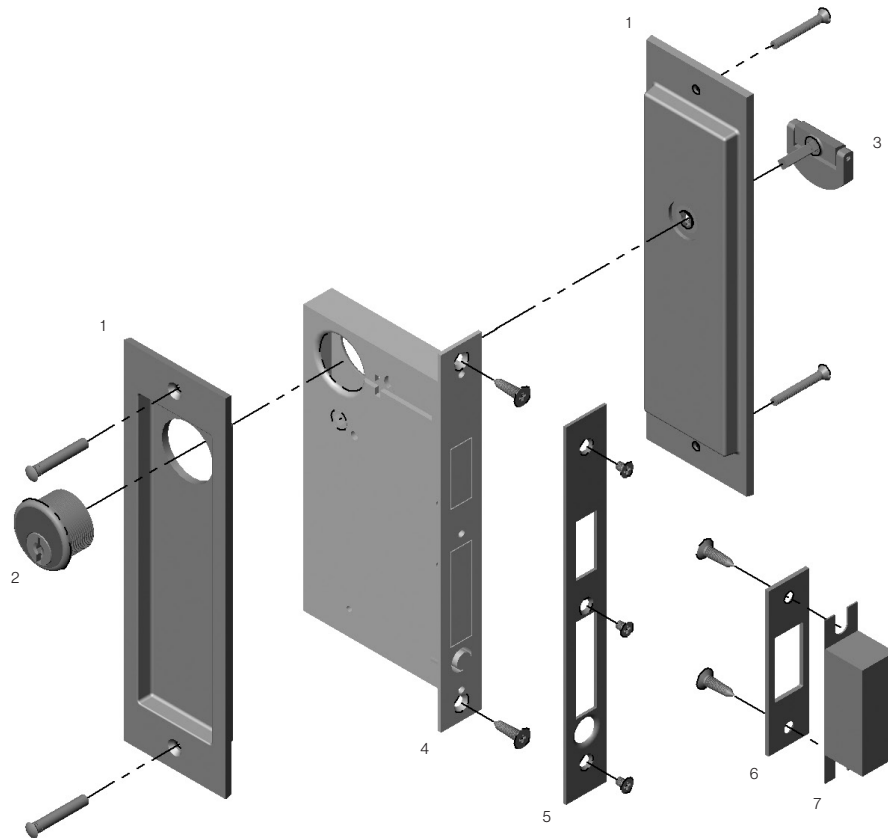

Sliding Door Information

1. Manufacture _____ (Pella, Marvin, etc.)
2. Function _____ (Patio, Entry, or Dummy)
3. Stile Width _____ (Inches)
4. Back Set _____ (Inches)
5. Back Set _____ (Inches)
From jamb with door closed
6. Door thickness _____ (Inches)
7. Handing? _____ (OX, XO,... etc)
8. Hand sketch insert orientation with door in the unlocked position, include dimensions.

SLIDING DOOR PLAN VIEW

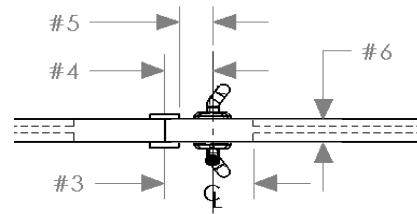

Examples of typical inserts & orientations:

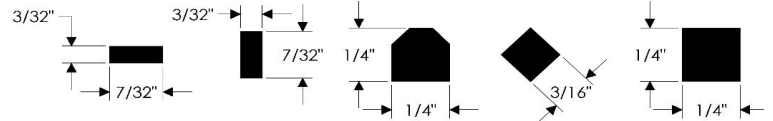

9. Hardware projection limitations? _____ (i.e. for screen door)
10. Mounting hole location:
 - a. Use existing mounting holes: YES (If yes, select option. See #11)
NO (If no, standard RMH spacing will be provided)
11. Screw Spacing check box below or supply custom screw spacing

*Up-charge applies

GRIP LOW

MANUFACTURER	DIM A	DIM B	DIM C
HOPPE	1-3/4" (1.772")	7-3/8" (7.362")	9 -1/8" (9.134")
JELDWEN (A)	1-13/16" (1.818")	5-7/16" (5.427")	7-1/4" (7.245")
JELDWEN (B)	1-15/16" (1.945")	8-5/16" (8.300")	10-1/4" (10.245")
KOLBE	1-31/32" (1.969")	8-9/32" (8.277")	10-1/4" (10.246")
MARVIN	1-9/16" (1.584")	9-5/8" (9.643")	11-1/4" (11.227")
MARVIN INTEGRITY	1-15/16" (1.945")	9-31/32" (9.975")	11-15/16" (11.920")
PELLA	23/32" (.700")	7-5/16" (7.300")	8.000"
ANDERSEN	1-15/16" (1.950")	9-13/16" (9.800")	11-3/4" (11.750")
SIERRA PACIFIC	1-3/4" (1.771")	7-3/8" (7.361")	9-1/8" (9.132")
WINDSOR	1-31/32" (1.969")	9-15/16" (9.951")	11-15/16" (11.920")
CUSTOM / OTHER			

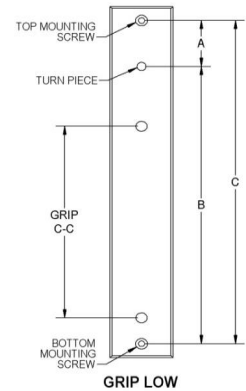

GRIP CENTERED

MANUFACTURER	DIM A	DIM B	DIM C
JELDWEN	2-23/32" (2.718")	1-1/4" (1.219")	3-15/16" (3.937")
EAGLE	1-1/4" (1.219")	2-23/32" (2.718")	3-15/16" (3.937")
MARVIN	4-15/16" (4.938")	4-15/16" (4.938")	9-7/8" (9.875")
MARVIN	1-15/16" (1.945")	1-15/16" (1.945")	3-31/32" (3.890")
CUSTOM / OTHER			

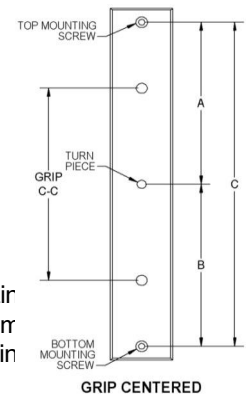



Purchase Order _____ **Custom trim is non-returnable.**

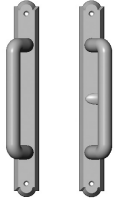
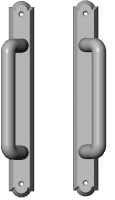
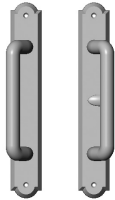

By signing below, you are confirming the above information is correct and giving Rocky Mountain Hardware approval to match information provided. This sheet will be the approval for the custom hardware you've requested. I have read, understand, approve and take full responsibility by signing below.

Approval Signature _____ Date: _____

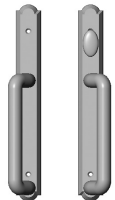
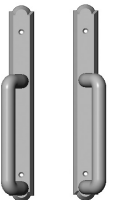
- Price includes SDP6, SDT6, G059, G258, G260, G645, G830, G10810, or G30300.
- Combinations are shown with SDP6, 6" Offset D Grip. Use G830 for low projection sliding doors. Refer to section G for grip specifications.
- Specify metal, patina, handing, backset, door thickness, and lock type.
- Refer to Section B for Escutcheon Specifications.

	ACTIVE	DUMMY	ESCUTCHEON OPTIONS
A	 <p>E708 E709</p>	 <p>E708 E708</p>	<p>A 13/8" x 11" Arched Escutcheon E708 / E709 Patio Sliding Door Trim..... \$ 762 E708 / E708 Full Dummy \$ 659</p> <ul style="list-style-type: none"> • Patio Trim includes TP800 Offset Turn Piece.
B	 <p>E760 E762</p>	 <p>E760 E760</p>	<p>B 13/4" x 11" Arched Escutcheon E760 / E762 Patio Sliding Door Trim..... \$ 795 E760 / E760 Full Dummy \$ 690</p> <ul style="list-style-type: none"> • Patio Trim includes TP800 Offset Turn Piece.
C	 <p>E714 E717</p>  <p>E715 E717</p>	 <p>E715 E715</p>	<p>C 13/8" x 11" Arched Escutcheon American Cylinder E714 / E717 Entry Sliding Door Trim \$ 893 E715 / E717 Patio Sliding Door Trim \$ 762 E715 / E715 Full Dummy..... \$ 659</p> <ul style="list-style-type: none"> • Entry Trim includes American Cylinder and TP600 Turn Piece. • Patio Trim includes TP600 Turn Piece.

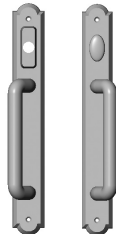
- Price includes SDP6, SDT6, G059, G258, G260, G645, G830, G10810, or G30300.
- Combinations are shown with SDP6, 6" Offset D Grip. Use G830 for low projection sliding doors. Refer to section G for grip specifications.
- Specify metal, patina, handing, backset, door thickness, and lock type.
- Refer to Section B for Escutcheon Specifications.

	ACTIVE	DUMMY	ESCUTCHEON OPTIONS
A	 <p>E798 E797</p>		<p>A 13/4" x 13" Arched Escutcheon American Cylinder E798 / E797 Entry Sliding Door Trim..... \$ 959 E796 / E797 Patio Sliding Door Trim..... \$ 827 E796 / E796 Full Dummy \$ 725</p> <ul style="list-style-type: none"> • Entry Trim includes American Cylinder and TP600 Turn Piece. • Patio Trim includes TP600 Turn Piece.
	 <p>E796 E797</p>	 <p>E796 E796</p>	

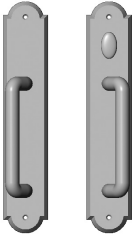
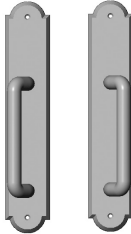
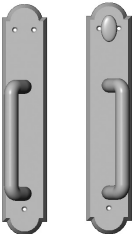
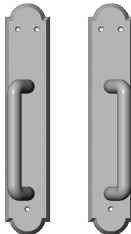

- Price includes SDP6, SDT6, G059, G258, G260, G645, G830, G10810, or G30300.
- Combinations are shown with SDP6, 6" Offset D Grip. Use G830 for low projection sliding doors. Refer to section G for grip specifications.
- Specify metal, patina, handing, backset, door thickness, and lock type.
- Refer to Section B for Escutcheon Specifications.

	ACTIVE	DUMMY	ESCUTCHEON OPTIONS
A	 <p>E790 E791</p>	 <p>E790 E790</p>	<p>A 2 1/2" x 13" Arched Escutcheon E790 / E791 Patio Sliding Door Trim \$ 850 E790 / E790 Full Dummy \$ 746</p> <p>• Patio Trim includes TP600 Turn Piece.</p>
B	 <p>E793 E794</p>	 <p>E793 E793</p>	<p>B 2 1/2" x 13" Arched Escutcheon E793 / E794 Patio Sliding Door Trim..... \$ 850 E793 / E793 Full Dummy \$ 746</p> <p>• Patio Trim includes TP600 Turn Piece.</p>

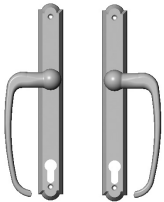
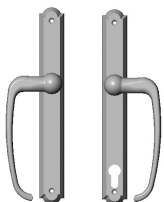
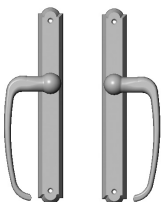
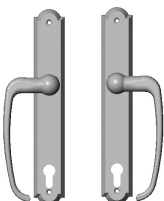
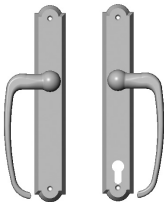
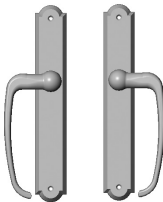



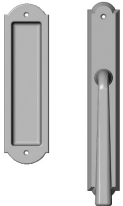

- Price includes L124 Offset Lever, as shown, or L177 Offset Tube Lever. Refer to Section A for lever specifications.
- Specify metal, patina, handing, backset, door thickness, lock type and center-to-center dimension.
- Refer to Section B for Escutcheon Specifications.

	ACTIVE	DUMMY	ESCUTCHEON OPTIONS
A	 <p>E720 E720</p>		<p>A 13/8" x 11" Arched Escutcheon Profile Cylinder E720 / E720 Entry Sliding Door Trim* \$ 1,062 E718 / E720 Patio Sliding Door Trim* \$ 985 E718 / E718 Full Dummy..... \$ 753</p> <ul style="list-style-type: none"> • Entry Trim includes Profile Cylinder with TP600 Turn Piece and 8mm Spindle. • Patio Trim includes 1/2 Profile Cylinder with TP600 Turn Piece and 8mm Spindle.
	 <p>E718 E720</p>	 <p>E718 E718</p>	
B	 <p>E740 E740</p>		
	 <p>E746 E740</p>	 <p>E746 E746</p>	

- Price includes your choice of lever (L114, L134, L138, L139, L142, L144, L145, L146, L148, L149, L157, L167, L168, L172, L173, L176, L180, L263, L264, L266, L331, L332, L10804, L21075, or L30145).
Refer to Section A for lever specifications.
- Combination is shown with L148 Long French Lever for illustration purposes.
- Specify metal, patina, handing, backset, door thickness, and lock type.
- Refer to Section B for Escutcheon Specifications.

ACTIVE	DUMMY	ESCUTCHEON OPTIONS
<p>A</p>  <p>FP259 E746</p>  <p>E746</p>		<p>A 13/4" x 11" Arched Lift & Slide Escutcheon/ 2 1/2" x 9" Flush Pull</p> <p>FP259 / E746 Lift and Slide Trim with Flush Pull..... \$ 653 E746 Lift and Slide Trim..... \$ 493</p> <ul style="list-style-type: none"> • Includes 10mm Spindle.

- Price includes SDP6, SDT6, G059, G258, G260, G645, G830, G10810, G30188, or G30300.
- Combinations are shown with G30188, 8" Cabernet Grip. Use G830 for low projection sliding doors. Refer to section G for grip specifications.
- Specify metal, patina, handing, backset, door thickness, and lock type.
- Refer to Section B for Escutcheon Specifications.

	ACTIVE	DUMMY	ESCUTCHEON OPTIONS
A	 E30870 E30871	 E30870 E30870	A 11/4" x 14 11/16" Bordeaux Escutcheon E30870 / E30871 Patio Sliding Door Trim \$ 944 E30870 / E30870 Full Dummy \$ 845 • Includes TP800 Offset Turn Piece.
B	 E30872 E30873	 E30872 E30872	B 11/4" x 17 11/16" Bordeaux Escutcheon E30872 / E30873 Patio Sliding Door Trim \$ 992 E30872 / E30872 Full Dummy \$ 886 • Includes TP800 Offset Turn Piece.
C	 E30880 E30881	 E30880 E30880	C 2" x 18 7/8" Bordeaux Escutcheon American Cylinder E30880 / E30881 Patio Sliding Door Trim \$ 1,722 E30880 / E30880 Full Dummy \$ 1,620 • Includes TP800 Offset Turn Piece.

- Price includes SDP6, SDT6, G059, G258, G260, G645, G830, G10810, G30188, or G30300.
- Combinations are shown with G30188, 8" Cabernet Grip. Use G830 for low projection sliding doors. Refer to section G for grip specifications.
- Specify metal, patina, handing, backset, door thickness, and lock type.
- Refer to Section B for Escutcheon Specifications.

ACTIVE

DUMMY

ESCUTCHEON OPTIONS

A



E30876 E30875



E30874 E30875

B



E30884 E30883



E30882 E30883



E30874 E30874



E30882 E30882

A 1 1/4" x 17 11/16" Bordeaux Escutcheon

E30876 / E30875 Entry Sliding Door Trim..... \$ 1,124

E30874 / E30875 Patio Sliding Door Trim \$ 992

E30874 / E30874 Full Dummy..... \$ 886

- Entry trim includes American Cylinder and TP700 Turn Piece.
- Patio trim includes TP700 Turn Piece.

B 2" x 18 7/8" Bordeaux Escutcheon

American Cylinder

E30884 / E30883 Entry Sliding Door Trim..... \$ 1,842

E30882 / E30883 Patio Sliding Door Trim \$ 1,722

E30882 / E30882 Full Dummy..... \$ 1,620

- Entry Trim includes American Cylinder and TP700 Turn Piece.
- Patio Trim includes TP700 Turn Piece.

- Price includes L124 Offset Lever, as shown, or L177 Offset Tube Lever. Refer to Section A for lever specifications.
- Specify metal, patina, handing, backset, door thickness, lock type and center-to-center dimension.
- Refer to Section B for Escutcheon Specifications.

ACTIVE

DUMMY

ESCUTCHEON OPTIONS

A

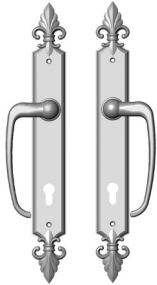

E30869 E30869

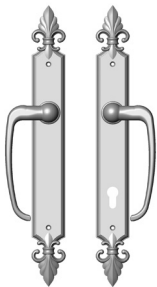

E30865 E30869

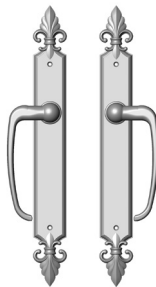

E30865 E30865



A 2" x 17" Bordeaux Escutcheon

Profile Cylinder

E30869 / E30869 Entry Sliding Door Trim*	\$ 1,298
E30865 / E30869 Patio Sliding Door Trim*	\$ 1,196
E30865 / E30865 Full Dummy	\$ 937

- Entry Trim includes Profile Cylinder with TP700 Turn Piece and 8mm Spindle.
- Patio Trim includes 1/2 Profile Cylinder with TP700 Turn Piece and 8mm Spindle.
- * The center-to-center dimension will need to be verified before set can be ordered.

- Price includes your choice of lever (L114, L134, L138, L139, L142, L144, L145, L146, L148, L149, L157, L167, L168, L172, L173, L176, L180, L263, L264, L266, L331, L332, L10804, L21075, or L30145).
Refer to Section A for lever specifications.
- Combination is shown with L148 Long French Lever for illustration purposes.
- Specify metal, patina, handing, backset, door thickness, and lock type.
- Refer to Section B for Escutcheon Specifications.

ACTIVE	DUMMY	ESCUTCHEON OPTIONS
<p data-bbox="277 474 298 506">A</p>  <p data-bbox="334 789 513 821">FP259 E30865</p>  <p data-bbox="415 1188 513 1220">E30865</p>		<p data-bbox="919 474 1398 531">A 2" x 17" Bordeaux Lift & Slide Escutcheon / 2 1/2" x 9" Arched Flush Pull</p> <p data-bbox="951 531 1503 615">FP259 / E30865 Lift and Slide Trim with Flush Pull \$ 729 E30865 Lift and Slide Trim \$ 569</p> <ul style="list-style-type: none"> <li data-bbox="919 646 1195 674">• Includes 10mm Spindle.

- Price includes SDP6, SDT6, G059, G258, G260, G645, G830, G10810, or G30300.
- Combinations are shown with G10810, 6" Offset Briggs Grip. Use G830 for low projection sliding doors. Refer to section G for grip specifications.
- Specify metal, patina, handing, backset, door thickness, and lock type.
- Refer to Section B for Escutcheon Specifications.

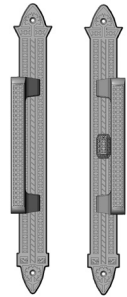
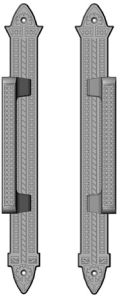
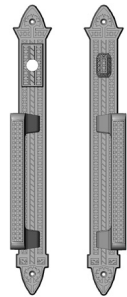
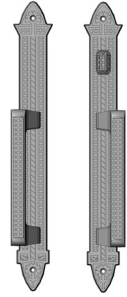
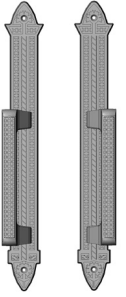
	ACTIVE	DUMMY	ESCUTCHEON OPTIONS
A	 <p>E10879 E10880</p>	 <p>E10879 E10879</p>	<p>A 2" x 15" Briggs Escutcheon</p> <p>E10879 / E10880 Patio Sliding Door Trim \$ 795</p> <p>E10879 / E10879 Full Dummy..... \$ 690</p> <ul style="list-style-type: none"> • Includes TP10801 Turn Piece.
B	 <p>E10881 E10882</p>  <p>E10883 E10882</p>	 <p>E10883 E10883</p>	<p>B 2" x 15" Briggs Escutcheon</p> <p>American Cylinder</p> <p>E10881 / E10882 Entry Sliding Door Trim \$ 927</p> <p>E10883 / E10882 Patio Sliding Door Trim \$ 795</p> <p>E10883 / E10883 Full Dummy \$ 690</p> <ul style="list-style-type: none"> • Entry Trim includes American cylinder and TP10801 turn piece. • Patio Trim includes TP10801 turn piece.

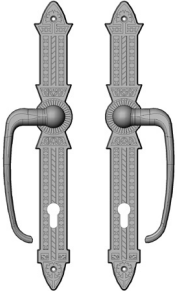
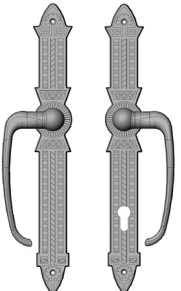
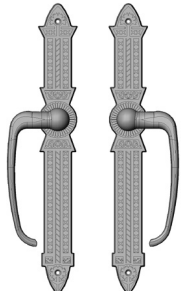

- Price includes L124 Offset Lever, as shown, or L177 Offset Tube Lever. Refer to Section A for lever specifications.
- Specify metal, patina, handing, backset, door thickness, and lock type.
- Refer to Section B for Escutcheon Specifications.

	ACTIVE	DUMMY	ESCUTCHEON OPTIONS
A	 <p>E10885 E10885</p>  <p>E10871 E10885</p>	 <p>E10871 E10871</p>	<p>A 2" x 15" Briggs Escutcheon Profile Cylinder</p> <p>E10885 / E10885 Entry Sliding Door Trim* \$1,095 E10871 / E10885 Patio Sliding Door Trim* \$1,017 E10871 / E10871 Full Dummy \$ 784</p> <ul style="list-style-type: none"> • Entry Trim includes Profile cylinder with TP10801 turn piece and 8mm Spindle. • Patio Trim includes 1/2 Profile cylinder with TP10801 turn piece and 8mm Spindle. • Escutcheon width varies. Narrowest width is 1 13/32". <p>* The center-to-center dimension will need to be verified before set can be ordered.</p>

- Price includes your choice of lever (L114, L134, L138, L139, L142, L144, L145, L146, L148, L149, L157, L167, L168, L172, L173, L176, L180, L263, L264, L266, L331, L332, L10804, L21075, or L30145).
Refer to Section A for lever specifications.
- Combination is shown with L148 Long French Lever for illustration purposes.
- Specify metal, patina, handing, backset, door thickness, and lock type.
- Refer to Section B for Escutcheon Specifications.

	ACTIVE	DUMMY	ESCUTCHEON OPTIONS
A	<p>FP259 E10871</p> <p>E10871</p>		<p>A 2" x 15" Briggs Lift & Slide Escutcheon 2 1/2" x 9" Arched Flush Pull FP259 / E10871 Lift & Slide Trim with Flush pull..... \$ 653 E10871 Lift & Slide Trim..... \$ 493</p> <ul style="list-style-type: none"> • Includes 10mm Spindle. Refer to spec page B25 and I66 • Escutcheon width varies. Narrowest width is 1 13/32".

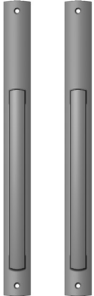

- Combinations below are only available with grip shown.
- Specify metal, patina, handing, backset, door thickness, and lock type.
- Refer to Section B for Escutcheon Specifications.

ACTIVE	DUMMY	ESCUTCHEON OPTIONS
<p>A</p>  <p>E30584 E30583</p>	 <p>E30582 E30582</p>	<p>A 1 1/4" x 14" Convex Escutcheon American Cylinder E30584 / E30583 Entry Sliding Door Trim \$ 1,076 E30582 / E30583 Patio Sliding Door Trim..... \$ 944 E30582 / E30582 Full Dummy \$ 845</p> <ul style="list-style-type: none"> • Entry Trim includes American Cylinder and TP200 Turn Piece. • Patio Trim includes TP200 Turn Piece.
 <p>E30582 E30583</p>		

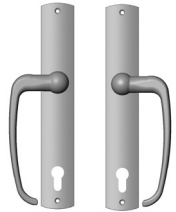
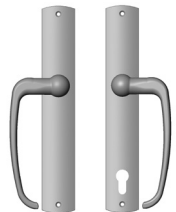
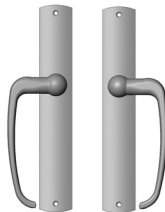
- Price includes L124 Offset Lever, as shown, or L177 Offset Tube Lever. Refer to Section A for lever specifications.
- Specify metal, patina, handing, backset, door thickness, lock type and center-to-center dimension.
- Refer to Section B for Escutcheon Specifications.

	ACTIVE	DUMMY	ESCUTCHEON OPTIONS
A	 <p>E30569 E30569</p>		<p>A 13/4" x 11" Convex Escutcheon Profile Cylinder</p> <p>E30569 / E30569 Entry Sliding Door Trim* \$ 1,298</p> <p>E30565 / E30569 Patio Sliding Door Trim * \$ 1,196</p> <p>E30565 / E30565 Full Dummy \$ 937</p> <ul style="list-style-type: none"> • Entry Trim includes Profile Cylinder with TP200 Turn Piece and 8mm Spindle. • Patio Trim includes 1/2 Profile Cylinder with TP200 Turn Piece and 8mm Spindle. <p>* The center-to-center dimension will need to be verified before set can be ordered.</p>
	 <p>E30565 E30569</p>		
		 <p>E30565 E30565</p>	

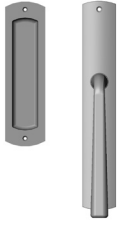
- Price includes your choice of lever (L114, L134, L138, L139, L142, L144, L145, L146, L148, L149, L157, L167, L168, L172, L173, L176, L180, L263, L264, L266, L331, L332, L10804, L21075, or L30145).
Refer to Section A for lever specifications.
- Combination is shown with L148 Long French for illustration purposes.
- Specify metal, patina, handing, backset, door thickness, and lock type.
- Refer to Section B for Escutcheon Specifications.

	ACTIVE	DUMMY	ESCUTCHEON OPTIONS
A	 <p>FP249 E30565</p>	 <p>E30565</p>	<p>A 13/4" x 11" Convex Lift & Slide ... Escutcheon / 2 1/2" x 9" Curved Flush Pull</p> <p>FP249 / E30565 Lift and Slide Trim with Flush Pull \$ 729</p> <p>E30565 Lift and Slide Trim \$ 569</p> <ul style="list-style-type: none"> • Includes 10mm Spindle

- Price includes SDP6, SDT6, G059, G258, G260, G645, G830, G10810, G30168, or G30300.
- Combinations are shown with G30168, 8" Pillar Grip. Use G830 for low projection sliding doors. Refer to section G for grip specifications.
- Specify metal, patina, handing, backset, door thickness, and lock type.
- Refer to Section B for Escutcheon Specifications.

ACTIVE

DUMMY

ESCUTCHEON OPTIONS

A

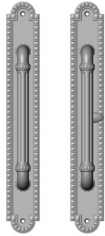

E30680 E30681

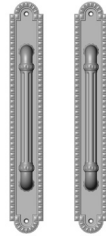

E30680 E30680

A 2" x 14" Corbel Arched Escutcheon

- E30680 / E30681 Patio Sliding Door Trim \$ 1,106
- E30680 / E30680 Full Dummy \$ 1,005

- Patio Trim includes TP800 Offset Turn Piece.

**B 2" x 14" Corbel Arched Escutcheon
American Cylinder**

- E30684 / E30683 Entry Sliding Door Trim \$ 1,238
- E30682 / E30683 Patio Sliding Door Trim \$ 1,106
- E30682 / E30682 Full Dummy \$ 1,005

- Patio Trim includes TP700 Turn Piece.

B

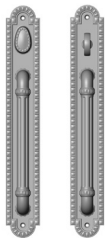

E30684 E30683

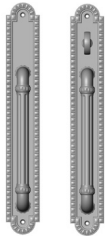

E30682 E30683

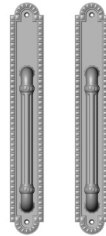

E30682 E30682

- Price includes L124 Offset Lever, as shown, or L177 Offset Tube Lever. Refer to Section A for lever specifications.
- Specify metal, patina, handing, backset, door thickness, lock type and center-to-center dimension.
- Refer to Section B for Escutcheon Specifications.

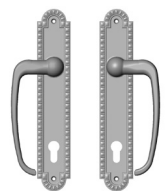
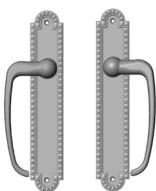
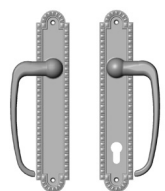
ACTIVE	DUMMY	ESCUTCHEON OPTIONS
<p>A</p>  <p>E30669 E30669</p>	 <p>E30665 E30665</p>	<p>A 2" x 11" Corbel Arched Escutcheon Profile Cylinder</p> <p>E30669 / E30669 Entry Sliding Door Trim* \$ 1,298 E30665 / E30669 Patio Sliding Door Trim* \$ 1,196 E30665 / E30665 Full Dummy \$ 937</p> <ul style="list-style-type: none"> • Entry Trim includes Profile Cylinder with TP700 Turn Piece and 8mm Spindle. • Patio Trim includes 1/2 Profile Cylinder with TP700 Turn Piece and 8mm Spindle. <p>* The center-to-center dimension will need to be verified before set can be ordered.</p>
 <p>E30665 E30669</p>		

- Price includes your choice of lever (L114, L134, L138, L139, L142, L144, L145, L146, L148, L149, L157, L167, L168, L172, L173, L176, L180, L263, L264, L266, L331, L332, L10804, L21075, or L30145).
Refer to Section A for lever specifications.
- Combination is shown with L148 Long French Lever for illustration purposes.
- Specify metal, patina, handing, backset, door thickness, and lock type.
- Refer to Section B for Escutcheon Specifications.

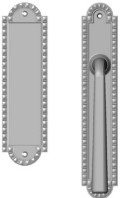
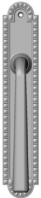
ACTIVE	DUMMY	ESCUTCHEON OPTIONS
<p>A</p>  <p>FP30600 E30665</p>  <p>E30665</p>		<p>A 2" x 11" Corbel Arched Lift & Slide Escutcheon/ 2 1/2" x 9" Corbel Arched Flush Pull</p> <p>FP30600 / E30665 Lift and Slide Trim with Flush Pull \$ 827</p> <p>E30665 Lift and Slide Trim \$ 569</p> <ul style="list-style-type: none"> • Includes 10mm Spindle.

- Price includes SDP6, SDT6, G059, G258, G260, G645, G830, G10810, G30168, or G30300.
- Combinations are shown with G30168, 8" Pillar Grip. Use G830 for low projection sliding doors. Refer to section G for grip specifications.
- Specify metal, patina, handing, backset, door thickness, and lock type.
- Refer to Section B for Escutcheon Specifications.

ACTIVE

DUMMY

ESCUTCHEON OPTIONS

A

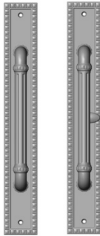

E30780 E30781

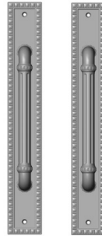

E30780 E30780

A 2" x 14" Corbel Rectangular Escutcheon

- E30780 / E30781 Patio Sliding Door Trim..... \$1,106
- E30780 / E30780 Full Dummy \$1,005

- Patio Trim includes TP800 Offset Turn Piece.

**B 2" x 14" Corbel Rectangular Escutcheon
American Cylinder**

- E30784 / E30783 Entry Sliding Door Trim..... \$1,238
- E30782 / E30783 Patio Sliding Door Trim..... \$1,106
- E30782 / E30782 Full Dummy..... \$1,005

- Patio Trim includes TP700 Turn Piece.

B

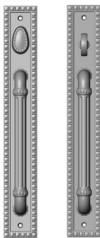

E30784 E30783

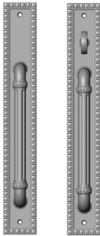

E30782 E30783

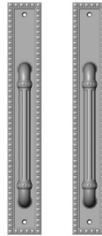

E30782 E30782

- Price includes L124 Offset Lever, as shown, or L177 Offset Tube Lever. Refer to Section A for lever specifications.
- Specify metal, patina, handing, backset, door thickness, lock type and center-to-center dimension.
- Refer to Section B for Escutcheon Specifications.

ACTIVE

DUMMY

ESCUTCHEON OPTIONS

A

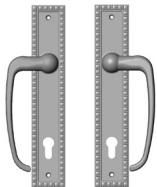

E30769 E30769

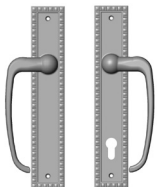

E30765 E30769

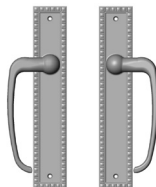

E30765 E30765

A 2" x 11" Corbel Rectangular Escutcheon Profile Cylinder

E30769 / E30769 Entry Sliding Door Trim*	\$ 1,298
E30765 / E30769 Patio Sliding Door Trim*	\$ 1,196
E30765 / E30765 Full Dummy	\$ 937

- Entry Trim includes Profile Cylinder with TP700 Turn Piece and 8mm Spindle.
- Patio Trim includes 1/2 Profile Cylinder with TP700 Turn Piece and 8mm Spindle.

* The center-to-center dimension will need to be verified before set can be ordered.

- Price includes your choice of lever (L114, L134, L138, L139, L142, L144, L145, L146, L148, L149, L157, L167, L168, L172, L173, L176, L180, L263, L264, L266, L331, L332, L10804, L21075, or L30145).
Refer to Section A for lever specifications.
- Combination is shown with L148 Long French Lever for illustration purposes.
- Specify metal, patina, handing, backset, door thickness, and lock type.
- Refer to Section B for Escutcheon Specifications.

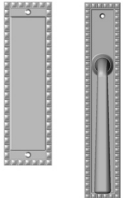
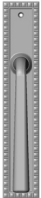
ACTIVE	DUMMY	ESCUTCHEON OPTIONS
<p>A</p>  <p>FP30700 E30765</p>  <p>E30765</p>		<p>A 2" x 11" Corbel Rectangular Lift & Slide Escutcheon / 2 1/2" x 8 1/2" Corbel Rectangular Flush Pull FP30700 / E30765 Lift and Slide Trim with Flush Pull \$ 827 E30765 Lift and Slide Trim \$ 569</p> <ul style="list-style-type: none"> • Includes 10mm Spindle.

- Price includes SDP6, SDT6, G059, G258, G260, G645, G830, G10810, or G30300.
- Combinations are shown with SDP6, 6" Offset D Grip. Use G830 for low projection sliding doors. Refer to section G for grip specifications.
- Specify metal, patina, handing, backset, door thickness, and lock type.
- Refer to Section B for Escutcheon Specifications.

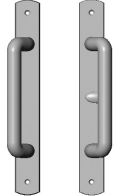
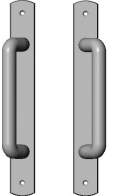
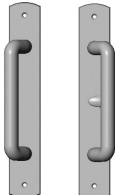
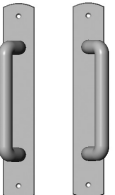
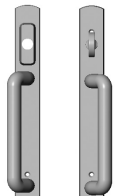
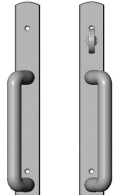
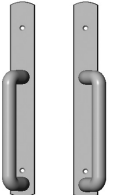
	ACTIVE	DUMMY	ESCUTCHEON OPTIONS
A	 <p>E518 E519</p>	 <p>E518 E518</p>	<p>A 13/8" x 11" Curved Escutcheon E518 / E519 Patio Sliding Door Trim \$ 762 E518 / E518 Full Dummy..... \$ 659</p> <ul style="list-style-type: none"> • Patio Trim includes TP800 Offset Turn Piece.
B	 <p>E551 E552</p>	 <p>E551 E551</p>	<p>B 13/4" x 11" Curved Escutcheon E551 / E552 Patio Sliding Door Trim..... \$ 795 E551 / E551 Full Dummy..... \$ 690</p> <ul style="list-style-type: none"> • Patio Trim includes TP800 Offset Turn Piece.
C	 <p>E526 E521</p>		<p>C 13/8" x 11" Curved Escutcheon American Cylinder E526 / E521 Entry Sliding Door Trim \$ 893 E520 / E521 Patio Sliding Door Trim \$ 762 E520 / E520 Full Dummy..... \$ 659</p> <ul style="list-style-type: none"> • Entry Trim includes American Cylinder and TP700 Turn Piece. • Patio Trim includes TP700 Turn Piece.
	 <p>E520 E521</p>	 <p>E520 E520</p>	

- Price includes SDP6, SDT6, G059, G258, G260, G645, G830, G10810, or G30300.
- Combinations are shown with SDP6, 6" Offset D Grip. Use G830 for low projection sliding doors. Refer to section G for grip specifications.
- Specify metal, patina, handing, backset, door thickness, and lock type.
- Refer to Section B for Escutcheon Specifications.

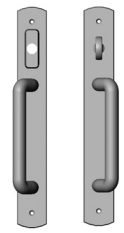
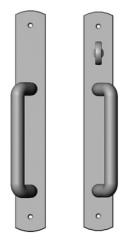
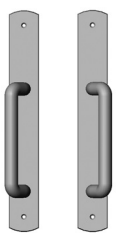
	ACTIVE	DUMMY	ESCUTCHEON OPTIONS
A	 <p>E563 E562</p>  <p>E561 E562</p>	 <p>E561 E561</p>	<p>A 13/4" x 13" Curved Escutcheon</p> <p>American Cylinder</p> <p>E563 / E562 Entry Sliding Door Trim \$ 959</p> <p>E561 / E562 Patio Sliding Door Trim \$ 827</p> <p>E561 / E561 Full Dummy \$ 725</p> <ul style="list-style-type: none"> • Entry Trim includes American Cylinder and TP700 Turn Piece. • Patio Trim includes TP700 Turn Piece.



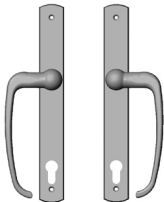
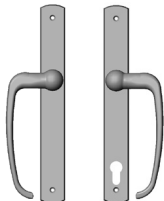
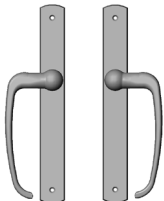
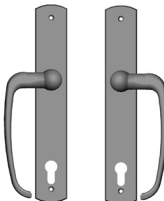
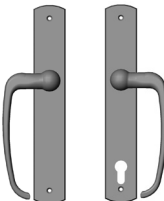
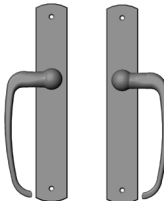

- Price includes L124 Offset Lever, as shown, or L177 Offset Tube Lever. Refer to Section A for lever specifications.
- Specify metal, patina, handing, backset, door thickness, lock type and center-to-center dimension.
- Refer to Section B for Escutcheon Specifications.

	ACTIVE	DUMMY	ESCUTCHEON OPTIONS
A	 <p>E564 E564</p>		<p>A 13/8" x 11" Curved Escutcheon Profile Cylinder</p> <p>E564 / E564 Entry Sliding Door Trim* \$ 1,062</p> <p>E576 / E564 Patio Sliding Door Trim* \$ 985</p> <p>E576 / E576 Full Dummy..... \$ 753</p> <ul style="list-style-type: none"> • Entry Trim includes Profile Cylinder with TP600 Turn Piece and 8mm Spindle. • Patio Trim includes 1/2 Profile Cylinder with TP600 Turn Piece and 8mm Spindle. <p>B 13/4" x 11" Curved Escutcheon Profile Cylinder</p> <p>E533 / E533 Entry Sliding Door Trim* \$ 1,095</p> <p>E530 / E533 Patio Sliding Door Trim* \$ 1,017</p> <p>E530 / E530 Full Dummy..... \$ 784</p> <ul style="list-style-type: none"> • Entry Trim includes Profile Cylinder with TP700 Turn Piece and 8mm Spindle. • Patio Trim includes 1/2 Profile Cylinder with TP700 Turn Piece and 8mm Spindle. <p>* The center-to-center dimension will need to be verified before set can be ordered.</p>
	 <p>E576 E564</p>	 <p>E576 E576</p>	
B	 <p>E533 E533</p>		
	 <p>E530 E533</p>	 <p>E530 E530</p>	

- Price includes your choice of lever (L114, L134, L138, L139, L142, L144, L145, L146, L148, L149, L157, L167, L168, L172, L173, L176, L180, L263, L264, L266, L331, L332, L10804, L21075, or L30145).
Refer to Section A for lever specifications.
- Combination is shown with L148 Long French Lever for illustration purposes.
- Specify metal, patina, handing, backset, door thickness, and lock type.
- Refer to Section B for Escutcheon Specifications.

ACTIVE	DUMMY	ESCUTCHEON OPTIONS
<p>A</p>  <p>FP249 E530</p> <p>E530</p>		<p>A 13/4" x 11" Curved Lift & Slide Escutcheon/ 2 1/2" x 9" Curved Flush Pull</p> <p>FP249 / E530 Lift and Slide Trim with Flush Pull \$ 653 E530 Lift and Slide Trim \$ 493</p> <ul style="list-style-type: none"> • Include 10mm Spindle.



- Price includes SDP6, SDT6, G059, G258, G260, G645, G830, G10810, or G30300.
- Combinations are shown with SDP6, 6" Offset D Grip. Use G830 for low projection sliding doors. Refer to section G for grip specifications.
- Specify metal, patina, handing, backset, door thickness, and lock type.
- Requires a minimum of 1 3/4" door thickness.
- Refer to Section B for Escutcheon Specifications.

	ACTIVE	DUMMY	ESCUTCHEON OPTIONS
A	 <p>E185 E186</p>	 <p>E185 E185</p>	<p>A 13/4" x 13" Edge Escutcheon</p> <p>E185 / E186 Patio Sliding Door Trim \$ 827</p> <p>E185 / E185 Full Dummy \$ 725</p> <ul style="list-style-type: none"> • Patio Trim includes TP800 Turn Piece.
B	 <p>E189 E188</p>  <p>E187 E188</p>	 <p>E187 E187</p>	<p>B 13/4" x 13" Edge Escutcheon</p> <p>American Cylinder</p> <p>E189 / E188 Entry Sliding Door Trim \$ 959</p> <p>E187 / E188 Patio Sliding Door Trim \$ 827</p> <p>E187 / E187 Full Dummy \$ 725</p> <ul style="list-style-type: none"> • Entry Trim includes American Cylinder and TP200 Turn Piece. • Patio Trim includes TP200 Turn Piece.

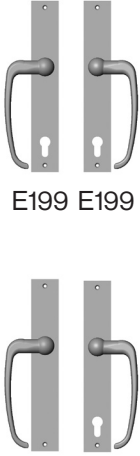
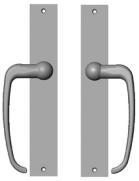

- Price includes L124 Offset Lever, as shown, or L177 Offset Tube Lever.
Refer to Section A for lever specifications.
- Specify metal, patina, handing, backset, door thickness, lock type and center-to-center dimension.
- Requires a minimum of 1 3/4" door thickness.
- Refer to Section B for Escutcheon Specifications.

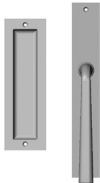
ACTIVE	DUMMY	ESCUTCHEON OPTIONS
<p data-bbox="277 478 298 506">A</p>  <p data-bbox="358 663 480 690">E199 E199</p> <p data-bbox="358 940 480 968">E195 E199</p>	 <p data-bbox="659 940 781 968">E195 E195</p>	<p data-bbox="919 478 1256 506">A 1 3/4" x 11" Edge Escutcheon</p> <p data-bbox="954 506 1122 533">Profile Cylinder</p> <p data-bbox="954 533 1523 560">E199 / E199 Entry Sliding Door Trim* \$ 1,095</p> <p data-bbox="954 560 1523 588">E195 / E199 Patio Sliding Door Trim* \$ 1,017</p> <p data-bbox="954 588 1523 615">E195 / E195 Full Dummy \$ 784</p> <ul style="list-style-type: none"> • Entry Trim includes Profile Cylinder with TP200 Turn Piece and 8mm Spindle. • Patio Trim includes 1/2 Profile Cylinder with TP200 Turn Piece and 8mm Spindle. <p data-bbox="919 730 1425 789">* The center-to-center dimension will need to be verified before set can be ordered.</p>

- Price includes your choice of lever (L114, L134, L138, L139, L142, L144, L145, L146, L148, L149, L157, L167, L168, L172, L173, L176, L180, L263, L264, L266, L331, L332, L10804, L21075, or L30145).
Refer to Section A for lever specifications.
- Combination is shown with L148 Long French Lever for illustration purposes.
- Specify metal, patina, handing, backset, door thickness, and lock type.
- Requires a minimum of 1 3/4" door thickness.
- Refer to Section B for Escutcheon Specifications.

ACTIVE	DUMMY	ESCUTCHEON OPTIONS
<p data-bbox="277 474 298 501">A</p>  <p data-bbox="358 680 506 707">FP208 E195</p>  <p data-bbox="436 968 495 995">E195</p>		<p data-bbox="919 474 1235 501">A 1 3/4" x 11" Edge Lift & Slide</p> <p data-bbox="954 504 1422 531">Escutcheon / 2 1/2" x 8" Rectangular Flush Pull</p> <p data-bbox="954 533 1276 560">FP208 / E195 Lift and Slide Trim</p> <p data-bbox="954 562 1507 590">with Flush Pull \$ 635</p> <p data-bbox="954 592 1507 619">E195 Lift and Slide Trim \$ 493</p> <ul style="list-style-type: none"> • Includes 10mm Spindle.

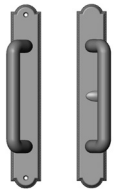
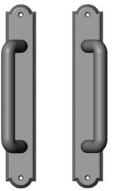

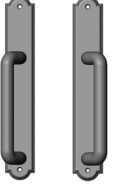
- Price includes SDP6, SDT6, G059, G258, G260, G645, G830, G10810, or G30300.
- Combinations are shown with SDP6, 6" Offset D Grip. Use G830 for low projection sliding doors. Refer to section G for grip specifications.
- Specify metal, patina, handing, backset, door thickness, and lock type.
- Refer to Section B for Escutcheon Specifications.

	ACTIVE	DUMMY	ESCUTCHEON OPTIONS
A	 <p>E027 E028</p>	 <p>E027 E027</p>	<p>A 13/4" x 11" Ellis Escutcheon</p> <p>E027 / E028 Patio Sliding Door Trim..... \$ 944</p> <p>E027 / E027 Full Dummy \$ 845</p> <ul style="list-style-type: none"> • Patio Trim includes TP800 Turn Piece.
B	 <p>E023 E022</p>  <p>E021 E022</p>	 <p>E021 E021</p>	<p>B 13/4" x 11" Ellis Escutcheon</p> <p>American Cylinder</p> <p>E023 / E022 Entry Sliding Door Trim \$1,076</p> <p>E021 / E022 Patio Sliding Door Trim \$ 944</p> <p>E021 / E021 Full Dummy \$ 845</p> <ul style="list-style-type: none"> • Entry Trim includes American Cylinder and TP050 Turn Piece. • Patio Trim includes TP050 Turn Piece.

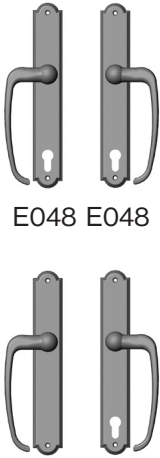
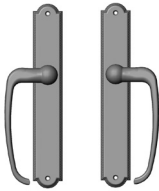

- Price includes L124 Offset Lever, as shown, or L177 Offset Tube Lever. Refer to Section A for lever specifications.
- Specify metal, patina, handing, backset, door thickness, lock type and center-to-center dimension.
- Refer to Section B for Escutcheon Specifications.

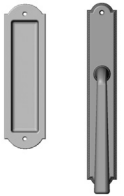
ACTIVE	DUMMY	ESCUTCHEON OPTIONS
<p>A</p>  <p>E048 E048</p> <p>E041 E048</p>	 <p>E041 E041</p>	<p>A 13/4" x 11" Ellis Escutcheon</p> <p>Profile Cylinder</p> <p>E048 / E048 Entry Sliding Door Trim* \$ 1,298</p> <p>E041 / E048 Patio Sliding Door Trim* \$ 1,196</p> <p>E041 / E041 Full Dummy \$ 937</p> <ul style="list-style-type: none"> • Entry Trim includes Profile Cylinder with TP050 Turn Piece and 8mm Spindle. • Patio Trim includes 1/2 Profile Cylinder with TP050 Turn Piece and 8mm Spindle. <p>* The center-to-center dimension will need to be verified before set can be ordered.</p>

- Price includes your choice of lever (L114, L134, L138, L139, L142, L144, L145, L146, L148, L149, L157, L167, L168, L172, L173, L176, L180, L263, L264, L266, L331, L332, L10804, L21075, or L30145).
Refer to Section A for lever specifications.
- Combination is shown with L148 Long French Lever for illustration purposes.
- Specify metal, patina, handing, backset, door thickness, and lock type.
- Refer to Section B for Escutcheon Specifications.

	ACTIVE	DUMMY	ESCUTCHEON OPTIONS
A	 <p>FP259 E041</p>  <p>E041</p>		<p>A 13/4" x 11" Ellis Lift & Slide Escutcheon / 2 1/2" x 9" Arched Flush Pull FP259 / E041 Lift and Slide Trim with Flush Pull \$ 729 E041 Lift and Slide Trim \$ 569</p> <ul style="list-style-type: none"> • Includes 10mm Spindle.

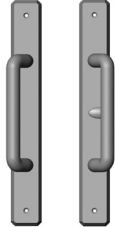
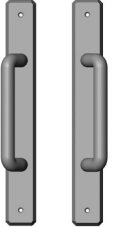

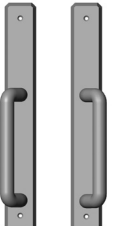
- Price includes SDP6, SDT6, G059, G258, G260, G645, G830, G10810, or G30300.
- Combinations are shown with SDP6, 6" Offset D Grip. Use G830 for low projection sliding doors. Refer to section G for grip specifications.
- Specify metal, patina, handing, backset, door thickness, and lock type.
- Refer to Section B for Escutcheon Specifications.

	ACTIVE	DUMMY	ESCUTCHEON OPTIONS
A	 <p>E30480 E30481</p>	 <p>E30480 E30480</p>	<p>A 13/4" x 13" Hammered Escutcheon E30480 / E30481 Patio Sliding Door Trim \$ 827 E30480 / E30480 Full Dummy \$ 725</p> <ul style="list-style-type: none"> • Includes TP800 Offset Turn Piece.
B	 <p>E30484 E30483</p>		<p>B 13/4" x 13" Hammered Escutcheon American Cylinder E30484 / E30483 Entry Sliding Door Trim \$ 959 E30482 / E30483 Patio Sliding Door Trim \$ 827 E30482 / E30482 Full Dummy \$ 725</p> <ul style="list-style-type: none"> • Entry Trim includes American Cylinder and TP200 Turn Piece. • Patio Trim includes TP200 Turn Piece.
	 <p>E30482 E30483</p>	 <p>E30482 E30482</p>	

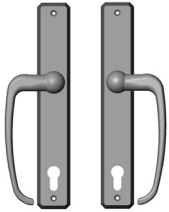
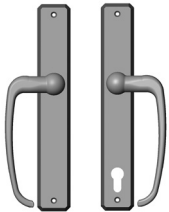
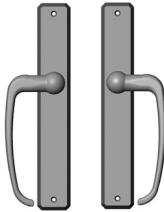
- Price includes L124 Offset Lever, as shown, or L177 Offset Tube Lever. Refer to Section A for lever specifications.
- Specify metal, patina, handing, backset, door thickness, lock type and center-to-center dimension.
- Refer to Section B for Escutcheon Specifications.

	ACTIVE	DUMMY	ESCUTCHEON OPTIONS
A	 <p>E30469 E30469</p>  <p>E30465 E30465</p>	 <p>E30465 E30465</p>	<p>A 13/4" x 11" Hammered Escutcheon Profile Cylinder</p> <p>E30469 / E30469 Entry Sliding Door Trim* \$ 1,095 E30465 / E30469 Patio Sliding Door Trim * \$ 1,017 E30465 / E30465 Full Dummy \$ 784</p> <ul style="list-style-type: none"> • Entry Trim includes Profile Cylinder with TP200 Turn Piece and 8mm Spindle. • Patio Trim includes 1/2 Profile Cylinder with TP200 Turn Piece and 8mm Spindle. <p>* The center-to-center dimension will need to be verified before set can be ordered.</p>

- Price includes your choice of lever (L114, L134, L138, L139, L142, L144, L145, L146, L148, L149, L157, L167, L168, L172, L173, L176, L180, L263, L264, L266, L331, L332, L10804, L21075, or L30145).
Refer to Section A for lever specifications.
- Combination is shown with L148 Long French for illustration purposes.
- Specify metal, patina, handing, backset, door thickness, and lock type.
- Refer to Section B for Escutcheon Specifications.

	ACTIVE	DUMMY	ESCUTCHEON OPTIONS
A	 <p>FP208 E30465</p>	 <p>E30465</p>	<p>A 13/4" x 11" Hammered Lift & Slide Escutcheon / 2" x 8" Rectangular Flush Pull FP208 / E30465 Lift and Slide Trim with Flush Pull \$ 635 E30465 Lift and Slide Trim \$ 493</p> <ul style="list-style-type: none"> • Includes 10mm Spindle

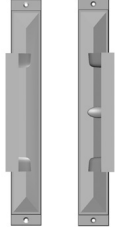
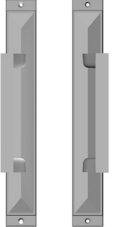
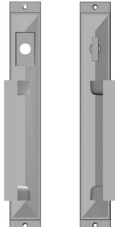
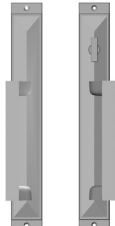
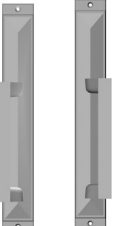

- Price includes SDP6, SDT6, G059, G258, G260, G645, G830, G10810, or G30300.
- Combinations are shown with G258, 6" Offset Rail Grip. Use G830 for low projection sliding doors. Refer to section G for grip specifications.
- Specify metal, patina, handing, backset, door thickness, and lock type.
- Refer to Section B for Escutcheon Specifications.

	ACTIVE	DUMMY	ESCUTCHEON OPTIONS
A	 <p>E21027 E21028</p>	 <p>E21027 E21027</p>	<p>A 13/4" x 13" Mack Escutcheon</p> <p>E21027 / E21028 Patio Sliding Door Trim \$ 827</p> <p>E21027 / E21027 Full Dummy..... \$ 725</p> <ul style="list-style-type: none"> • Includes TP800 Offset Turn Piece.
B	 <p>E21023 E21022</p>		<p>B 13/4" x 13" Mack Escutcheon American Cylinder</p> <p>E21023 / E21022 Entry Sliding Door Trim..... \$ 959</p> <p>E21021 / E21022 Patio Sliding Door Trim..... \$ 827</p> <p>E21021 / E21021 Full Dummy..... \$ 725</p> <ul style="list-style-type: none"> • Entry Trim includes American Cylinder and TP200 Turn Piece. • Patio Trim includes TP200 Turn Piece.
	 <p>E21021 E21022</p>	 <p>E21021 E21021</p>	

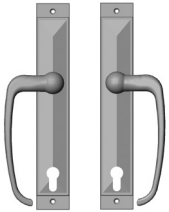
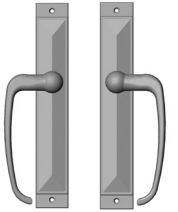
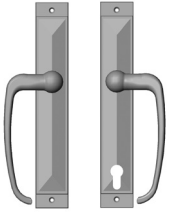
- Price includes L124 Offset Lever, as shown, or L177 Offset Tube Lever. Refer to Section A for lever specifications.
- Specify metal, patina, handing, backset, door thickness, lock type and center-to-center dimension.
- Refer to Section B for Escutcheon Specifications.

ACTIVE	DUMMY	ESCUTCHEON OPTIONS
<p>A</p>  <p>E21048 E21048</p>	 <p>E21041 E21041</p>	<p>A 13/4" x 11" Mack Escutcheon Profile Cylinder</p> <p>E21048 / E21048 Entry Sliding Door Trim* \$ 1,095</p> <p>E21041 / E21048 Patio Sliding Door Trim * \$ 1,017</p> <p>E21041 / E21041 Full Dummy..... \$ 784</p> <ul style="list-style-type: none"> • Entry Trim includes Profile Cylinder with TP200 Turn Piece and 8mm Spindle. • Patio Trim includes 1/2 Profile Cylinder with TP200 Turn Piece and 8mm Spindle. <p>* The center-to-center dimension will need to be verified before set can be ordered.</p>
 <p>E21041 E21048</p>		

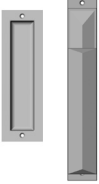
- Price includes your choice of lever (L114, L134, L138, L139, L142, L144, L145, L146, L148, L149, L157, L167, L168, L172, L173, L176, L180, L263, L264, L266, L331, L332, L10804, L21075, or L30145).
Refer to Section A for lever specifications.
- Combination is shown with L21075 Long Emile Lever for illustration purposes.
- Specify metal, patina, handing, backset, door thickness, and lock type.
- Refer to Section B for Escutcheon Specifications.

ACTIVE	DUMMY	ESCUTCHEON OPTIONS
<p>A</p>  <p>FP208 E21041</p>  <p>E21041</p>		<p>A 13/4" x 11" Mack Lift & Slide Escutcheon / 2" x 8" Rectangular Flush Pull FP208 / E21041 Lift and Slide Trim with Flush Pull \$ 635 E21041 Lift and Slide Trim..... \$ 493</p> <ul style="list-style-type: none"> • Includes 10mm Spindle



- Price includes SDP6, SDT6, G059, G258, G260, G645, G830, G10810, or G30300.
- Combinations are shown with SDP6, 6" Offset D Grip. Use G830 for low projection sliding doors. Refer to section G for grip specifications.
- Specify metal, patina, handing, backset, door thickness, and lock type.
- Refer to Section B for Escutcheon Specifications.

	ACTIVE	DUMMY	ESCUTCHEON OPTIONS
A	<p style="margin-top: 10px;">E598 E599</p>	<p style="margin-top: 10px;">E598 E598</p>	<p>A 13/4" x 11" Maddox Escutcheon</p> <p>E598 / E599 Patio Sliding Door Trim..... \$ 944</p> <p>E598 / E598 Full Dummy..... \$ 845</p> <ul style="list-style-type: none"> • Patio Trim includes TP800 Offset Turn Piece.

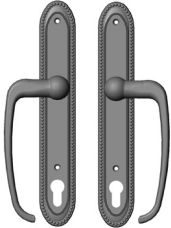
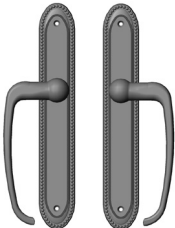
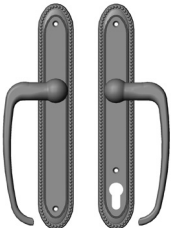
- Price includes L124 Offset Lever, as shown, or L177 Offset Tube Lever. Refer to Section A for lever specifications.
- Specify metal, patina, handing, backset, door thickness, lock type and center-to-center dimension.
- Refer to Section B for Escutcheon Specifications.

ACTIVE	DUMMY	ESCUTCHEON OPTIONS
<p>A</p>  <p>E593 E593</p>	 <p>E591 E591</p>	<p>A 13/4" x 11" Maddox Escutcheon</p> <p>Profile Cylinder</p> <p>E593 / E593 Entry Sliding Door Trim* \$ 1,298</p> <p>E591 / E593 Patio Sliding Door Trim* \$ 1,196</p> <p>E591 / E591 Full Dummy \$ 937</p> <ul style="list-style-type: none"> • Entry Trim includes Profile Cylinder with TP580 Turn Piece and 8mm Spindle. • Patio Trim includes TP580 Turn Piece. <p>* The center-to-center dimension will need to be verified before set can be ordered.</p>
 <p>E591 E593</p>		

- Price includes your choice of lever (L114, L134, L138, L139, L142, L144, L145, L146, L148, L149, L157, L167, L168, L172, L173, L176, L180, L263, L264, L266, L331, L332, L10804, L21075, or L30145).
Refer to Section A for lever specifications.
- Combination is shown with L148 Long French Lever for illustration purposes.
- Specify metal, patina, handing, backset, door thickness, and lock type.
- Refer to Section B for Escutcheon Specifications.

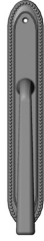
	ACTIVE	DUMMY	ESCUTCHEON OPTIONS
A	  FP249 E591	 E591	A 13/4" x 11" Maddox Lift & Slide Escutcheon/ 2 1/2" x 9" Curved Flush Pull FP249 / E591 Lift and Slide Trim with Flush Pull \$ 729 E591 Lift and Slide Trim \$ 569 • Includes 10mm Spindle.

- Price includes SDP6, SDT6, G059, G258, G260, G645, G830, G10810, or G30300.
- Combinations are shown with G260, 6" Offset Curved Rail Grip. Use G830 for low projection sliding doors. Refer to section G for grip specifications.
- Specify metal, patina, handing, backset, door thickness, and lock type.
- Note: To compliment the Designer Series with Sliding Door Hardware, RMH recommends utilizing the Metro Collection.
- Refer to Section B for Escutcheon Specifications.

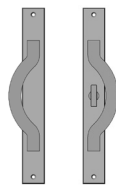
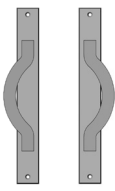
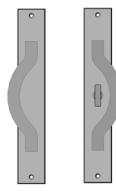
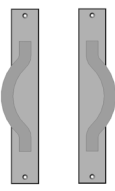
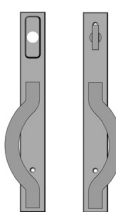
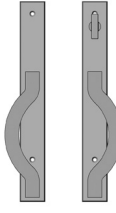
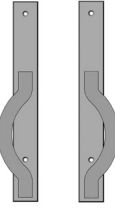
	ACTIVE	DUMMY	ESCUTCHEON OPTIONS
A	 <p>E218 E219</p>	 <p>E218 E218</p>	<p>A 13/8" x 11" Metro Escutcheon E218 / E219 Patio Sliding Door Trim..... \$ 762 E218 / E218 Full Dummy \$ 659</p> <ul style="list-style-type: none"> • Patio Trim includes TP200 Turn Piece.
B	 <p>E227 E228</p>	 <p>E227 E227</p>	<p>B 13/4" x 11" Metro Escutcheon E227 / E228 Patio Sliding Door Trim..... \$ 795 E227 / E227 Full Dummy..... \$ 690</p> <ul style="list-style-type: none"> • Patio Trim includes TP200 Turn Piece.
C	 <p>E235 E234</p>  <p>E220 E234</p>	 <p>E220 E220</p>	<p>C 13/8" x 11" Metro Escutcheon American Cylinder E235 / E234 Entry Sliding Door Trim \$ 893 E220 / E234 Patio Sliding Door Trim..... \$ 762 E220 / E220 Full Dummy..... \$ 659</p> <ul style="list-style-type: none"> • Entry Trim includes American Cylinder and TP200 Turn Piece. • Patio Trim includes TP200 Turn Piece.

- Price includes SDP6, SDT6, G059, G258, G260, G645, G830, G10810, or G30300.
- Combinations are shown with G260, 6" Offset Curved Rail Grip. Use G830 for low projection sliding doors. Refer to section G for grip specifications.
- Specify metal, patina, handing, backset, door thickness, and lock type.
- Note: To compliment the Designer Series with Sliding Door Hardware, RMH recommends utilizing the Metro Collection.
- Refer to Section B for Escutcheon Specifications.

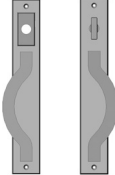
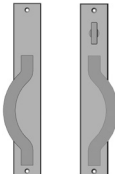
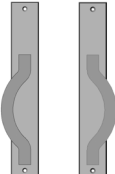
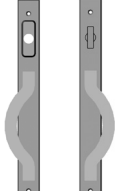
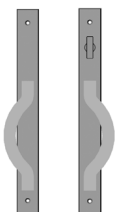
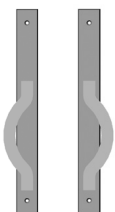
	ACTIVE	DUMMY	ESCUTCHEON OPTIONS
A	 E223 E222		A 13/4" x 11" Metro Escutcheon American Cylinder E223 / E222 Entry Sliding Door Trim \$ 924 E221 / E222 Patio Sliding Door Trim \$ 795 E221 / E221 Full Dummy \$ 690 • Entry Trim includes American Cylinder and TP200 Turn Piece. • Patio Trim includes TP200 Turn Piece.
	 E221 E222	 E221 E221	
B	 E279 E278		B 13/8" x 13" Metro Escutcheon American Cylinder E279 / E278 Entry Sliding Door Trim..... \$ 926 E277 / E278 Patio Sliding Door Trim \$ 795 E277 / E277 Full Dummy..... \$ 690 • Entry Trim includes American Cylinder and TP200 Turn Piece. • Patio Trim includes TP200 Turn Piece.
	 E277 E278	 E277 E277	

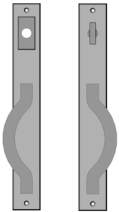
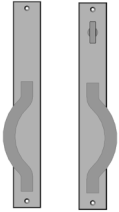
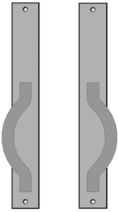

- Price includes SDP6, SDT6, G059, G258, G260, G645, G830, G10810, or G30300.
- Combinations are shown with G260, 6" Offset Curved Rail Grip. Use G830 for low projection sliding doors. Refer to section G for grip specifications.
- Specify metal, patina, handing, backset, door thickness, and lock type.
- Note: To compliment the Designer Series with Sliding Door Hardware, RMH recommends utilizing the Metro Collection.
- Refer to Section B for Escutcheon Specifications.

	ACTIVE	DUMMY	ESCUTCHEON OPTIONS						
A	 <p>E226 E225</p>  <p>E224 E225</p>	 <p>E224 E224</p>	<p>A 13/4" x 13" Metro Escutcheon American Cylinder</p> <table> <tr> <td>E226 / E225 Entry Sliding Door Trim</td> <td>\$ 959</td> </tr> <tr> <td>E224 / E225 Patio Sliding Door Trim.....</td> <td>\$ 827</td> </tr> <tr> <td>E224 / E224 Full Dummy</td> <td>\$ 725</td> </tr> </table> <ul style="list-style-type: none"> • Entry Trim includes American Cylinder and TP200 Turn Piece. • Patio Trim includes TP200 Turn Piece. 	E226 / E225 Entry Sliding Door Trim	\$ 959	E224 / E225 Patio Sliding Door Trim.....	\$ 827	E224 / E224 Full Dummy	\$ 725
E226 / E225 Entry Sliding Door Trim	\$ 959								
E224 / E225 Patio Sliding Door Trim.....	\$ 827								
E224 / E224 Full Dummy	\$ 725								

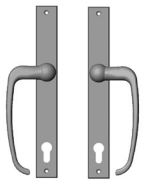
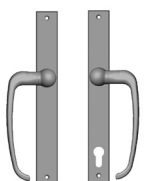
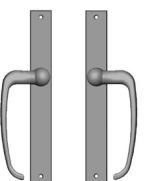
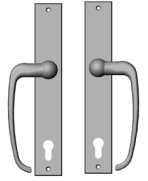
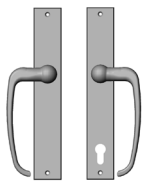
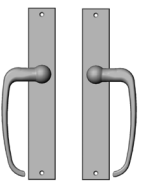

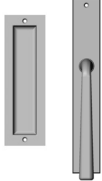

- Price includes L124 Offset Lever, as shown, or L177 Offset Tube Lever. Refer to Section A for lever specifications.
- Specify metal, patina, handing, backset, door thickness, lock type and center-to-center dimension.
- Refer to Section B for Escutcheon Specifications.

	ACTIVE	DUMMY	ESCUTCHEON OPTIONS
A	 <p>E275 E275</p>		<p>A 13/8" x 11" Metro Escutcheon Profile Cylinder</p> <p>E275 / E275 Entry Sliding Door Trim* \$ 1,062</p> <p>E270 / E275 Patio Sliding Door Trim* \$ 985</p> <p>E270 / E270 Full Dummy \$ 753</p> <ul style="list-style-type: none"> • Entry Trim includes Profile Cylinder with TP200 Turn Piece and 8mm Spindle. • Patio Trim includes 1/2 Profile Cylinder with TP200 Turn Piece and 8mm Spindle.
	 <p>E270 E275</p>	 <p>E270 E270</p>	
B	 <p>E248 E248</p>		
	 <p>E241 E248</p>	 <p>E241 E241</p>	

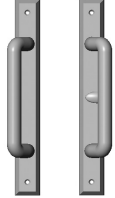
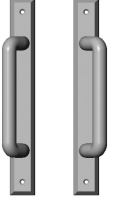

- Price includes your choice of lever (L114, L134, L138, L139, L142, L144, L145, L146, L148, L149, L157, L167, L168, L172, L173, L176, L180, L263, L264, L266, L331, L332, L10804, L21075, or L30145).
Refer to Section A for lever specifications.
- Combination is shown with L148 Long French Lever for illustration purposes.
- Specify metal, patina, handing, backset, door thickness, and lock type.
- Refer to Section B for Escutcheon Specifications.

ACTIVE	DUMMY	ESCUTCHEON OPTIONS
<p>A</p> 		<p>A 13/4" x 11" Metro Lift & Slide Escutcheon / 2 1/2" x 8" Rectangular Flush Pull FP208 / E241 Lift and Slide Trim with Flush Pull \$ 635 E241 Lift and Slide Trim..... \$ 493</p> <ul style="list-style-type: none"> • Includes 10mm Spindle.
<p>FP208 E241</p>		
		
<p>E241</p>		

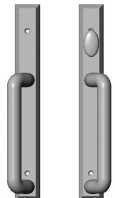
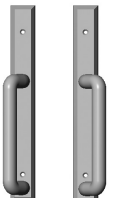
- Price includes SDP6, SDT6, G059, G258, G260, G645, G830, G10810, or G30300.
- Combinations are shown with SDP6, 6" Offset D Grip. Use G830 for low projection sliding doors. Refer to section G for grip specifications.
- Specify metal, patina, handing, backset, door thickness, and lock type.
- Refer to Section B for Escutcheon Specifications.

	ACTIVE	DUMMY	ESCUTCHEON OPTIONS
A	 E468 E469	 E468 E468	A 13/8" x 11" Rectangular Escutcheon E468 / E469 Patio Sliding Door Trim..... \$ 762 E468 / E468 Full Dummy \$ 659 • Includes TP800 Offset Turn Piece.
B	 E444 E466	 E444 E444	B 13/4" x 11" Rectangular Escutcheon E444 / E466 Patio Sliding Door Trim..... \$ 795 E444 / E444 Full Dummy \$ 690 • Includes TP800 Offset Turn Piece.
C	 E485 E482  E484 E482	 E484 E484	C 13/8" x 11" Rectangular Escutcheon <i>American Cylinder</i> E485 / E482 Entry Sliding Door Trim \$ 893 E484 / E482 Patio Sliding Door Trim..... \$ 762 E484 / E484 Full Dummy \$ 659 • Entry Trim includes American Cylinder and TP600 Turn Piece. • Patio Trim includes TP600 Turn Piece.

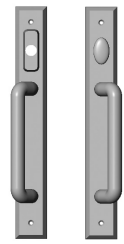
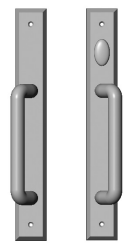
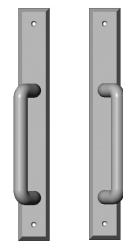
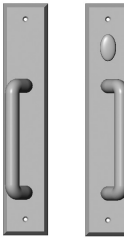

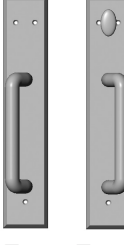
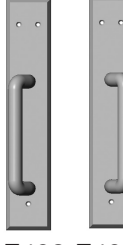
- Price includes SDP6, SDT6, G059, G258, G260, G645, G830, G10810, or G30300.
- Combinations are shown with SDP6, 6" Offset D Grip. Use G830 for low projection sliding doors. Refer to section G for grip specifications.
- Specify metal, patina, handing, backset, door thickness, and lock type.
- Refer to Section B for Escutcheon Specifications.

	ACTIVE	DUMMY	ESCUTCHEON OPTIONS
A	 <p>E498 E497</p>		<p>A 13/4" x 13" Rectangular Escutcheon American Cylinder</p> <p>E498 / E497 Entry Sliding Door Trim \$ 959</p> <p>E496 / E497 Patio Sliding Door Trim..... \$ 827</p> <p>E496 / E496 Full Dummy \$ 725</p> <ul style="list-style-type: none"> • Entry Trim includes American Cylinder and TP600 Turn Piece. • Patio Trim includes TP600 Turn Piece.
	 <p>E496 E497</p>	 <p>E496 E496</p>	<p>B 2 1/2" x 13" Rectangular Escutcheon</p> <p>E490 / E491 Patio Sliding Door Trim \$ 850</p> <p>E490 / E490 Full Dummy \$ 746</p> <ul style="list-style-type: none"> • Patio Trim includes TP600 Turn Piece
B	 <p>E490 E491</p>	 <p>E490 E490</p>	
C	 <p>E493 E494</p>	 <p>E493 E493</p>	<p>C 2 1/2" x 13" Rectangular Escutcheon</p> <p>E493 / E494 Patio Sliding Door Trim..... \$ 850</p> <p>E493 / E493 Full Dummy \$ 746</p> <ul style="list-style-type: none"> • Patio Trim includes TP600 Turn Piece

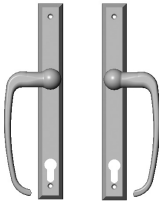
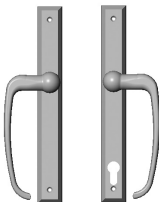
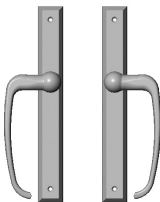
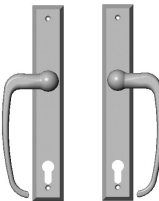
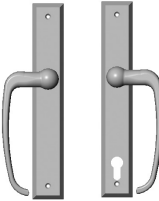
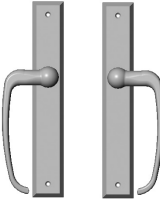

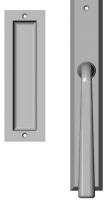

- Price includes L124 Offset Lever, as shown, or L177 Offset Tube Lever. Refer to Section A for lever specifications.
- Specify metal, patina, handing, backset, door thickness, lock type and center-to-center dimension.
- Refer to Section B for Escutcheon Specifications.

	ACTIVE	DUMMY	ESCUTCHEON OPTIONS
A	 <p>E440 E440</p>		<p>A 13/8" x 11" Rectangular Escutcheon Profile Cylinder</p> <p>E440 / E440 Entry Sliding Door Trim* \$ 1,062</p> <p>E456 / E440 Patio Sliding Door Trim* \$ 985</p> <p>E456 / E456 Full Dummy \$ 753</p> <ul style="list-style-type: none"> • Entry Trim includes Profile Cylinder with TP600 Turn Piece and 8mm Spindle. • Patio Trim includes 1/2 Profile Cylinder with TP600 Turn Piece and 8mm Spindle.
	 <p>E456 E440</p>	 <p>E456 E456</p>	
B	 <p>E449 E449</p>		
	 <p>E446 E449</p>	 <p>E446 E446</p>	

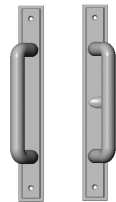

- Price includes your choice of lever (L114, L134, L138, L139, L142, L144, L145, L146, L148, L149, L157, L167, L168, L172, L173, L176, L180, L263, L264, L266, L331, L332, L10804, L21075, or L30145).
Refer to Section A for lever specifications.
- Combination is shown with L148 Long French Lever for illustration purposes.
- Specify metal, patina, handing, backset, door thickness, and lock type.
- Refer to Section B for Escutcheon Specifications.

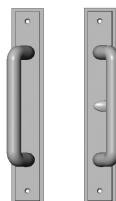
	ACTIVE	DUMMY	ESCUTCHEON OPTIONS
A	 <p>FP208 E446</p>		<p>A 13/4" x 11" Rectangular Lift & Slide Escutcheon / 2 1/2" x 8" Rectangular Flush Pull FP208 / E446 Lift and Slide Trim with Flush Pull \$ 635 E446 Lift and Slide Trim..... \$ 493</p> <ul style="list-style-type: none"> • Includes 10mm Spindle.
	 <p>E446</p>		

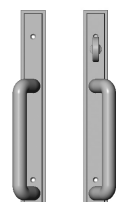
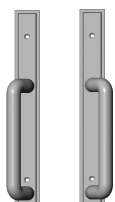
- Price includes SDP6, SDT6, G059, G258, G260, G645, G830, G10810, or G30300.
- Combinations are shown with SDP6, 6" Offset D Grip. Use G830 for low projection sliding doors. Refer to section G for grip specifications.
- Specify metal, patina, handing, backset, door thickness, and lock type.
- Refer to Section B for Escutcheon Specifications.

	ACTIVE	DUMMY	ESCUTCHEON OPTIONS
A	 <p>E318 E319</p>	 <p>E318 E318</p>	<p>A 13/8" x 11" Stepped Escutcheon E318 / E319 Patio Sliding Door Trim..... \$ 762 E318 / E318 Full Dummy \$ 659</p> <ul style="list-style-type: none"> • Patio Trim includes TP800 Offset Turn Piece.
B	 <p>E351 E352</p>	 <p>E351 E351</p>	<p>B 13/4" x 11" Stepped Escutcheon E351 / E352 Patio Sliding Door Trim..... \$ 795 E351 / E351 Full Dummy..... \$ 690</p> <ul style="list-style-type: none"> • Patio Trim includes TP800 Offset Turn Piece.
C	 <p>E326 E321</p>  <p>E320 E321</p>	 <p>E320 E320</p>	<p>C 13/8" x 11" Stepped Escutcheon American Cylinder E326 / E321 Entry Sliding Door Trim..... \$ 893 E320 / E321 Patio Sliding Door Trim \$ 762 E320 / E320 Full Dummy..... \$ 659</p> <ul style="list-style-type: none"> • Entry Trim includes American Cylinder and TP700 Turn Piece. • Patio Trim includes TP700 Turn Piece.

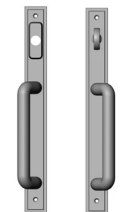
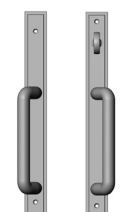
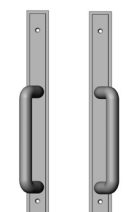
- Price includes SDP6, SDT6, G059, G258, G260, G645, G830, G10810, or G30300.
- Combinations are shown with SDP6, 6" Offset D Grip. Use G830 for low projection sliding doors. Refer to section G for grip specifications.
- Specify metal, patina, handing, backset, door thickness, and lock type.
- Refer to Section B for Escutcheon Specifications.

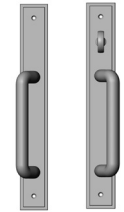
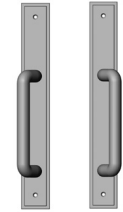
	ACTIVE	DUMMY	ESCUTCHEON OPTIONS
A	 <p>E372 E371</p>		<p>A 13/8" x 13" Stepped Escutcheon American Cylinder E372 / E371 Entry Sliding Door Trim \$ 926 E370 / E371 Patio Sliding Door Trim..... \$ 795 E370 / E370 Full Dummy \$ 690</p> <ul style="list-style-type: none"> • Entry Trim includes American Cylinder and TP700 Turn Piece. • Patio Trim includes TP700 Turn Piece. <p>B 13/4" x 13" Stepped Escutcheon American Cylinder E343 / E342 Entry Sliding Door Trim \$ 959 E341 / E342 Patio Sliding Door Trim \$ 827 E341 / E341 Full Dummy..... \$ 725</p> <ul style="list-style-type: none"> • Entry Trim includes American Cylinder and TP700 Turn Piece. • Patio Trim includes TP700 Turn Piece.
	 <p>E370 E371</p>	 <p>E370 E370</p>	
B	 <p>E343 E342</p>		
	 <p>E341 E342</p>	 <p>E341 E341</p>	

- Price includes L124 Offset Lever, as shown, or L177 Offset Tube Lever. Refer to Section A for lever specifications.
- Specify metal, patina, handing, backset, door thickness, lock type and center-to-center dimension.
- Refer to Section B for Escutcheon Specifications.

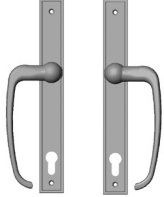
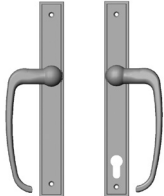
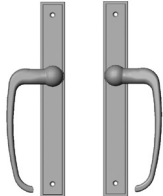
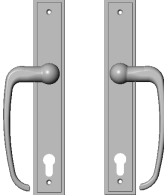
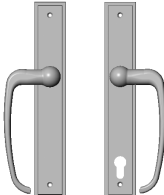
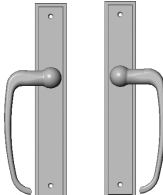

	ACTIVE	DUMMY	ESCUTCHEON OPTIONS
A	 <p>E374 E374</p>		<p>A 13/8" x 11" Stepped Escutcheon Profile Cylinder E374 / E374 Entry Sliding Door Trim* \$ 1,062 E376 / E374 Patio Sliding Door Trim* \$ 985 E376 / E376 Full Dummy \$ 753</p> <ul style="list-style-type: none"> • Entry Trim includes Profile Cylinder with TP700 Turn Piece and 8mm Spindle. • Patio Trim includes 1/2 Profile Cylinder with TP700 Turn Piece and 8mm Spindle.
	 <p>E376 E374</p>	 <p>E376 E376</p>	
B	 <p>E333 E333</p>		
	 <p>E330 E333</p>	 <p>E330 E330</p>	

- Price includes your choice of lever (L114, L134, L138, L139, L142, L144, L145, L146, L148, L149, L157, L167, L168, L172, L173, L176, L180, L263, L264, L266, L331, L332, L10804, L21075, or L30145).
Refer to Section A for lever specifications.
- Combination is shown with L148 Long French Lever for illustration purposes.
- Specify metal, patina, handing, backset, door thickness, and lock type.
- Refer to Section B for Escutcheon Specifications.



A 13/4" x 11" Stepped Lift & Slide Escutcheon / 2 1/2" x 8" Rectangular Flush Pull
 FP208 / E330 Lift and Slide Trim with
 Flush Pull \$ 635
 E330 Active Trim..... \$ 493
 • Includes 10mm Spindle.

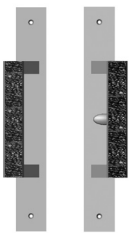
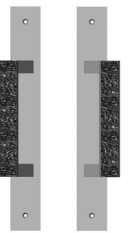
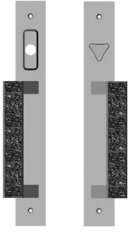
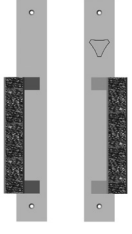

- Price includes SDP6, SDT6, G059, G258, G260, G645, G830, G10810, or G30300.
- Combinations are shown with G30300, 6" Offset Trousdale Grip. Use G830 for low projection sliding doors. Refer to section G for grip specifications.
- Specify metal, patina, handing, backset, door thickness, and lock type.
- Refer to Section B for Escutcheon Specifications.

	ACTIVE	DUMMY	ESCUTCHEON OPTIONS
A	 <p>E30380 E30381</p>	 <p>E30380 E30380</p>	<p>A 13/4" x 13" Trousdale Escutcheon Kravitz Design Collection E30380 / E30381 Patio Sliding Door Trim..... \$1,106 E30380 / E30380 Full Dummy..... \$1,005</p> <ul style="list-style-type: none"> • Includes TP800 Offset Turn Piece.
B	 <p>E30384 E30383</p>		<p>B 13/4" x 13" Trousdale Escutcheon Kravitz Design Collection American Cylinder E30384 / E30383 Entry Sliding Door Trim..... \$1,238 E30382 / E30383 Patio Sliding Door Trim \$1,106 E30382 / E30382 Full Dummy \$1,005</p> <ul style="list-style-type: none"> • Entry Trim includes American Cylinder and TP30301 Turn Piece. • Patio Trim includes TP30301 Turn Piece.
	 <p>E30382 E30383</p>	 <p>E30382 E30382</p>	

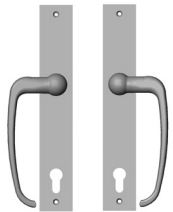
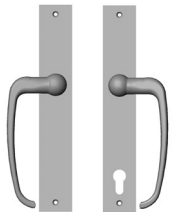
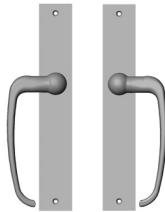
- Price includes L124 Offset Lever, as shown, or L177 Offset Tube Lever. Refer to Section A for lever specifications.
- Specify metal, patina, handing, backset, door thickness, lock type and center-to-center dimension.
- Refer to Section B for Escutcheon Specifications.

	ACTIVE	DUMMY	ESCUTCHEON OPTIONS
A	 <p>E30369 E30369</p>  <p>E30365 E30369</p>	 <p>E30365 E30365</p>	<p>A 13/4" x 11" Trousdale Escutcheon Profile Cylinder Kravitz Design Collection</p> <p>E30369 / E30369 Entry Sliding Door Trim* \$ 1,298 E30365 / E30369 Patio Sliding Door Trim * \$ 1,196 E30365 / E30365 Full Dummy \$ 937</p> <ul style="list-style-type: none"> • Entry Trim includes Profile Cylinder with TP30301 Turn Piece and 8mm Spindle. • Patio Trim includes 1/2 Profile Cylinder with TP30301 Turn Piece and 8mm Spindle. <p>* The center-to-center dimension will need to be verified before set can be ordered.</p>

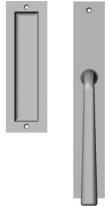
- Price includes your choice of lever (L114, L134, L138, L139, L142, L144, L145, L146, L148, L149, L157, L167, L168, L172, L173, L176, L180, L263, L264, L266, L331, L332, L10804, L21075, or L30145).
Refer to Section A for lever specifications.
- Combination is shown with L148 Long French for illustration purposes.
- Specify metal, patina, handing, backset, door thickness, and lock type.
- Refer to Section B for Escutcheon Specifications.

	ACTIVE	DUMMY	ESCUTCHEON OPTIONS
A	 <p>FP208 E30365</p>  <p>E30365</p>		<p>A 13/4" x 11" Trousdale Lift & Slide Escutcheon / 2" x 8" Rectangular Flush Pull Kravitz Design Collection</p> <p>FP208 / E30365 Lift and Slide Trim with Flush Pull \$ 711</p> <p>E30365 Lift and Slide Trim \$ 569</p> <ul style="list-style-type: none"> • Includes 10mm Spindle

- Specify metal, patina, and door thickness.

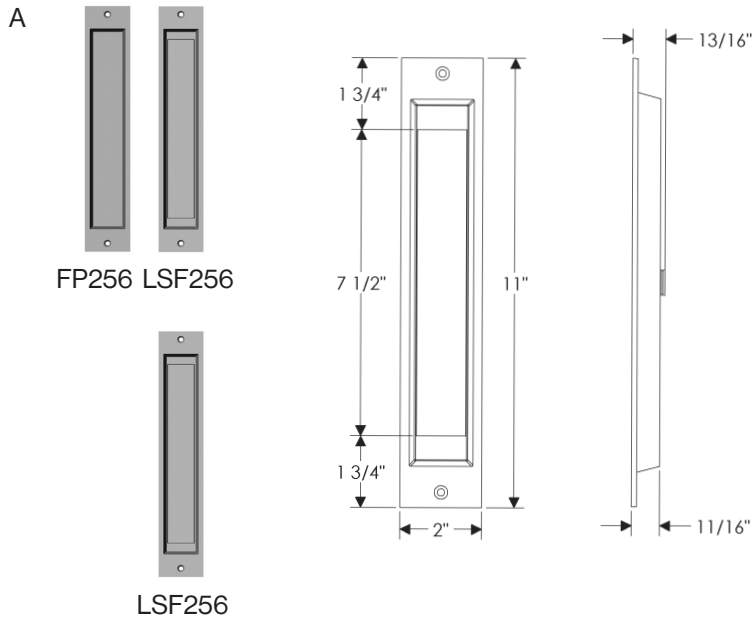

A 2" x 11" Rectangular Folding Lift & Slide Escutcheon / 2" x 11" Rectangular Flush Pull
 FP256 / LSF256 Folding Lift and Slide Trim with Flush Pull \$ 739
 LSF256 Folding Lift and Slide Trim..... \$ 552

- Includes 10mm Spindle.

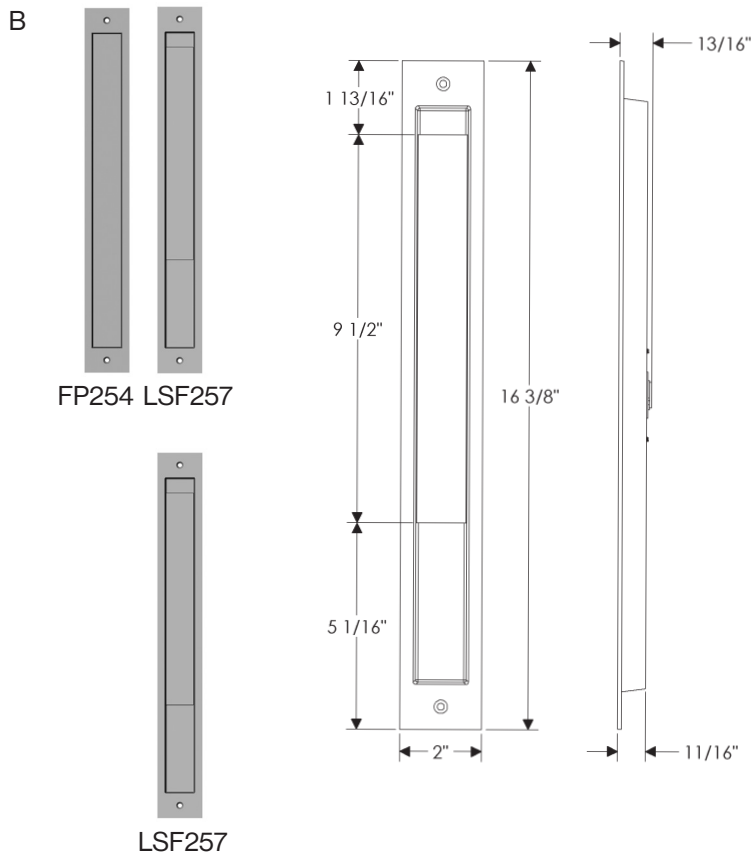
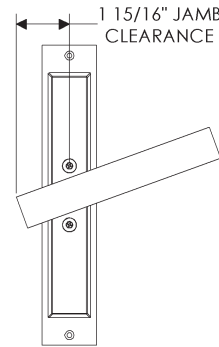

B 2" x 16 3/8" Rectangular Folding Lift & Slide Escutcheon / 2" x 16 3/8" Rectangular Flush Pull
 FP254 / LSF257 Folding Lift and Slide Trim with Flush Pull \$ 886
 LSF257 Folding Lift and Slide Trim..... \$ 653

- Includes 10mm Spindle.

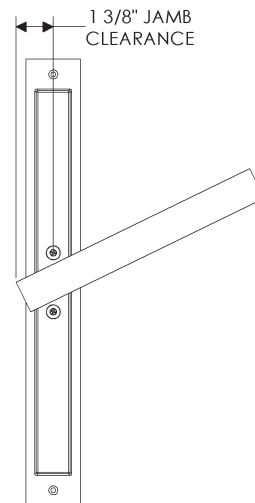

- Specify metal and patina.

Flush Pulls



FP216

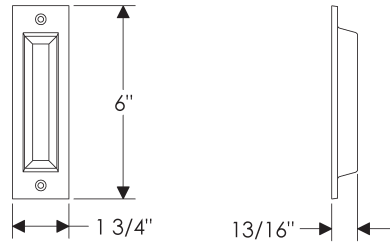

FP216 Flush Pull — Rectangular

1 3/4" x 6" \$ 116

• Note: This will not work back-to-back on doors less than 1 3/4."



FP209

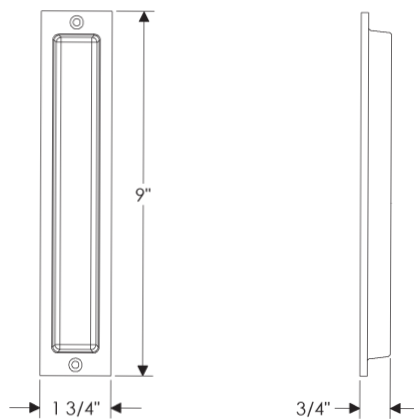

FP209 Flush Pull — Rectangular

1 3/4" x 9" \$ 152



FP212

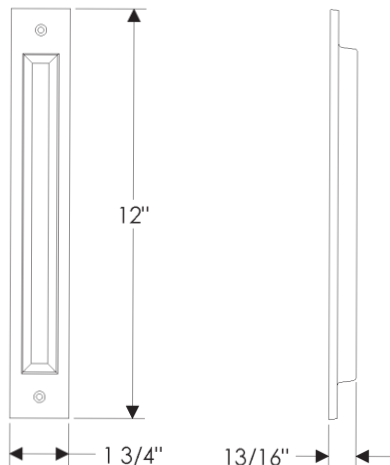

FP212 Flush Pull — Rectangular

1 3/4" x 12" \$ 187

• Note: This will not work back-to-back on doors less than 1 3/4."

- Specify metal and patina.

Flush Pulls

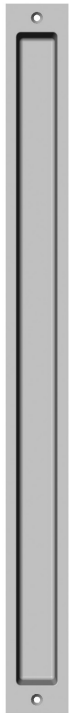

FP217

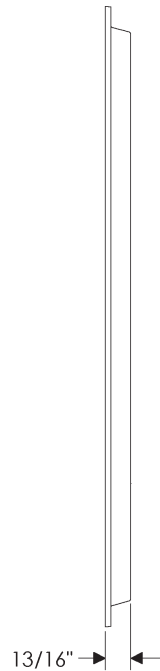
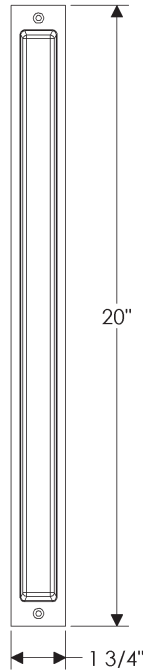

FP217 Flush Pull — Rectangular

1 3/4" x 20" \$ 344

• Note: This will not work back-to-back on doors less than 1 3/4."



FP204

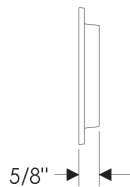
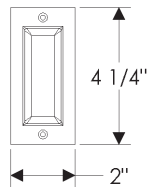

FP204 Flush Pull — Rectangular

2" x 4 1/4" \$ 83



FP218

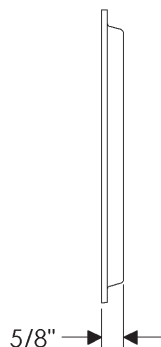
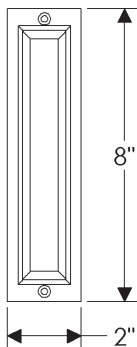

FP218 Flush Pull — Rectangular

2" x 8" \$ 152

- Specify metal and patina.

Flush Pulls

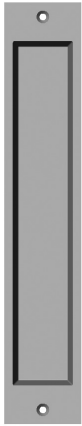

FP256

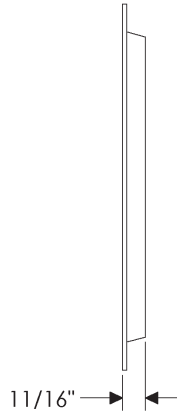
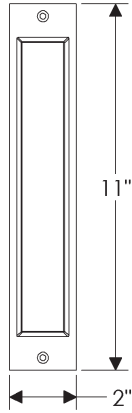

FP256 Flush Pull — Rectangular

2" x 11" \$187

- Note: This will not work back-to-back on doors less than 1 1/2."

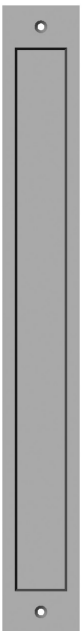

FP254

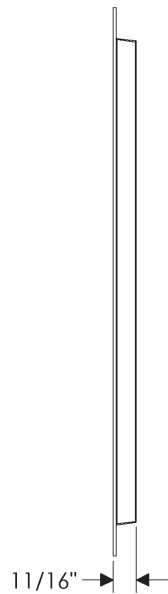
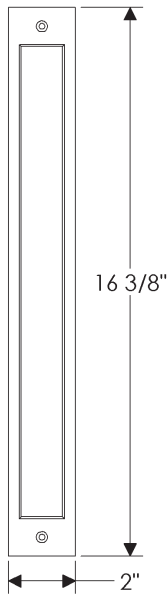

FP254 Flush Pull — Rectangular

2" x 16 3/8" \$233

- Note: This will not work back-to-back on doors less than 1 1/2."

- Specify metal and patina.

Flush Pulls

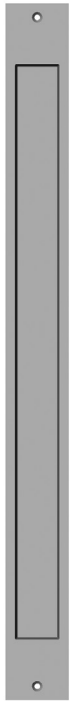

FP251

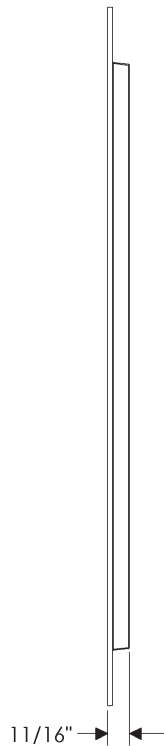
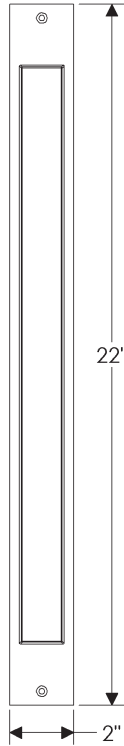

FP251 Flush Pull — Rectangular

2" x 22" \$354

• Note: This will not work back-to-back on doors less than 1 1/2."

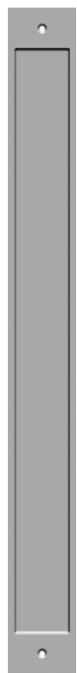

FP264

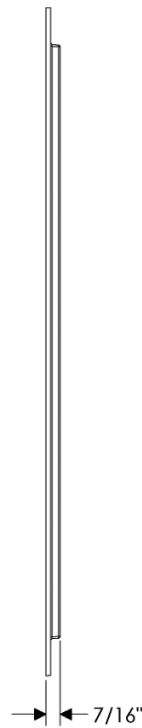
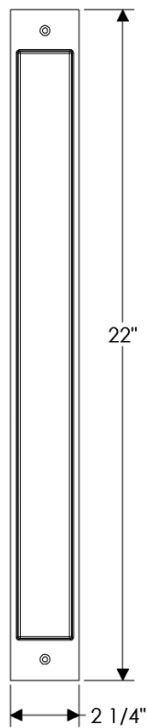

FP264 Flush Pull — Rectangular

2 1/4" x 22" \$373

- Specify metal and patina.

Flush Pulls



FP206

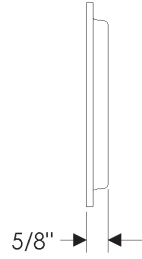
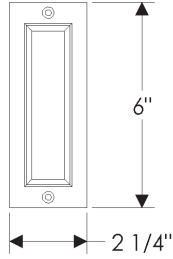

FP206 Flush Pull — Rectangular

2 1/4" x 6" \$ 113

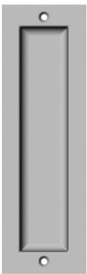

FP208

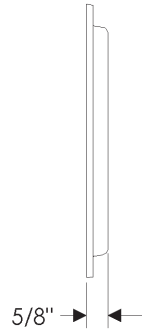
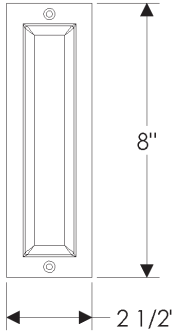

FP208 Flush Pull — Rectangular

2 1/2" x 8" \$142

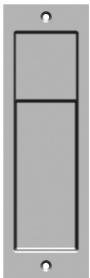

FP308

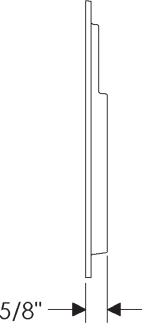
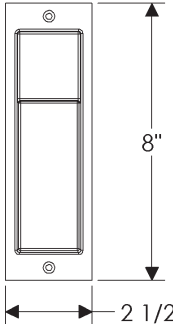

FP308 Flush Pull — Rectangular

2 1/2" x 8" \$142

- Specify metal and patina.

Flush Pulls



FP258

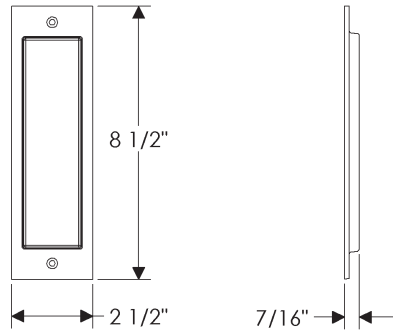

FP258 Flush Pull — Rectangular

2 1/2" x 8 1/2" \$142



FP210

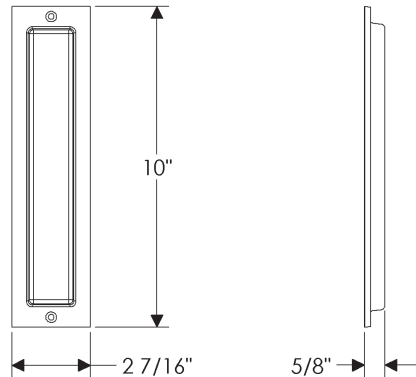

FP210 Flush Pull — Rectangular

2 7/16" x 10" \$187



FP268

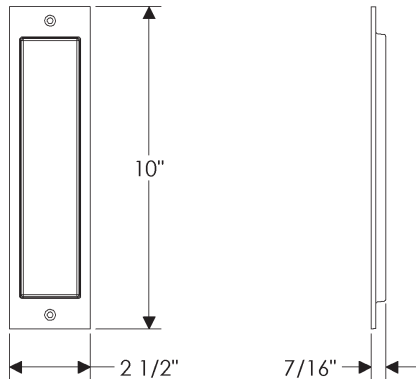

FP268 Flush Pull — Rectangular

2 1/2" x 10" \$187

- Specify metal and patina.

Flush Pulls



FP260

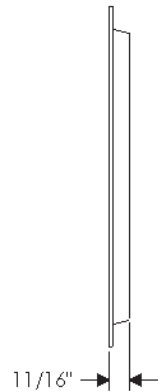
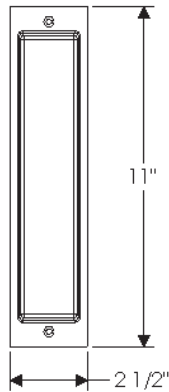

FP260 Flush Pull — Rectangular

2 1/2" x 11" \$ 204

• Note: This will not work back-to-back on doors less than 1 1/2."

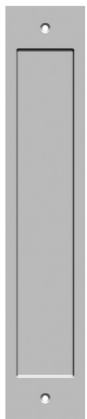

FP262

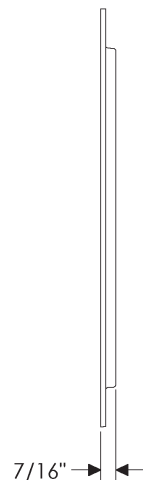
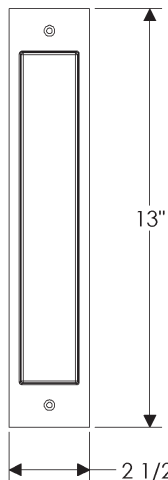

FP262 Flush Pull — Rectangular

2 1/2" x 13" \$ 214

- Specify metal and patina.

Flush Pulls

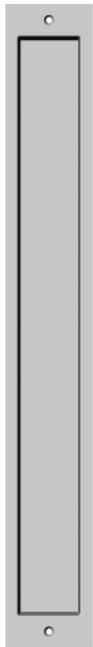

FP219

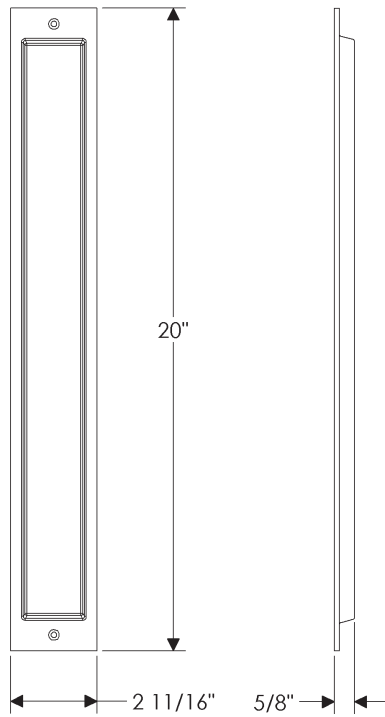

FP219 Flush Pull — Rectangular

2 11/16" x 20" \$ 349



FP1349

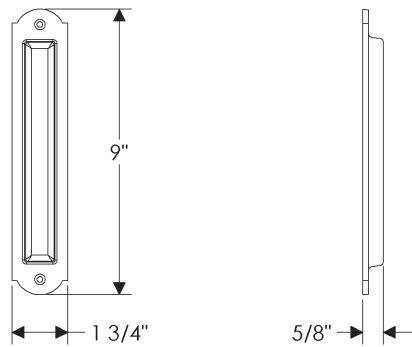

FP1349 Flush Pull — Arched

1 3/4" x 9" \$ 152

- Specify metal and patina.

Flush Pulls



FP259

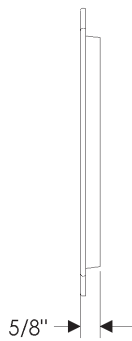
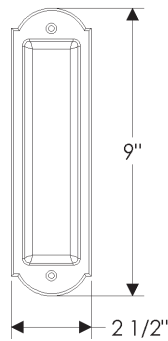

FP259 Flush Pull — Arched
 2 1/2" x 9" \$160

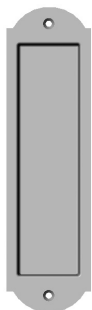

FP269

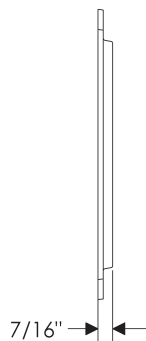
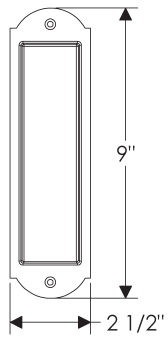

FP269 Flush Pull — Arched
 2 1/2" x 9" \$142



FP270

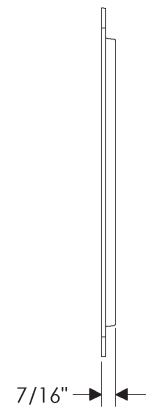
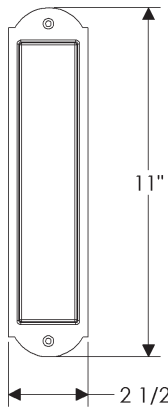

FP270 Flush Pull — Arched
 2 1/2" x 11" \$204

- Specify metal and patina.

Flush Pulls



FP253

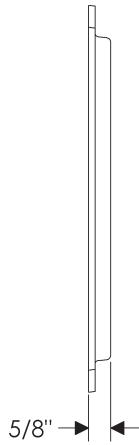
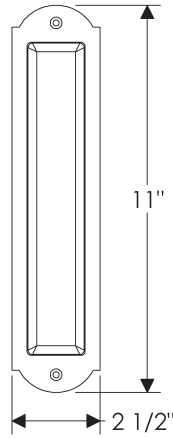

FP253 Flush Pull — Arched

2 1/2" x 11" \$204

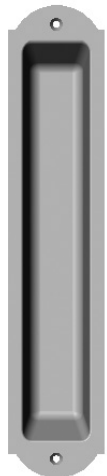

FP255

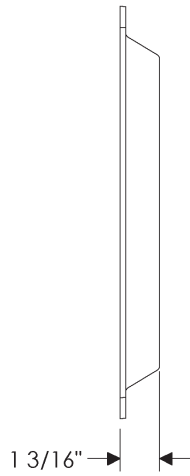
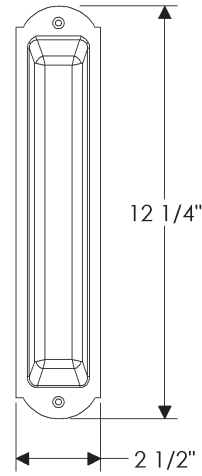

FP255 Flush Pull — Arched

2 1/2" x 12 1/4" \$213

• Note: This will not work back-to-back on doors less than 2 1/2."



FP224

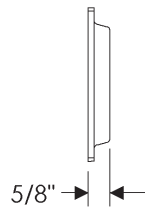
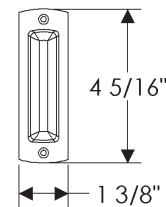

FP224 Flush Pull — Curved

1 3/8" x 4 5/16" \$83

- Specify metal and patina.

Flush Pulls



FP249

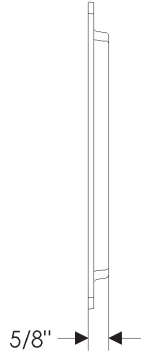
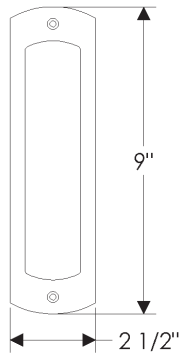

FP249 Flush Pull — Curved

2 1/2" x 9" \$160

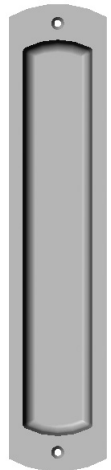

FP252

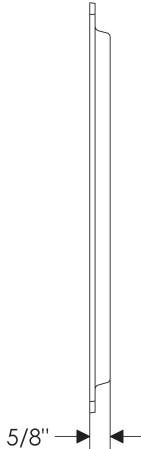
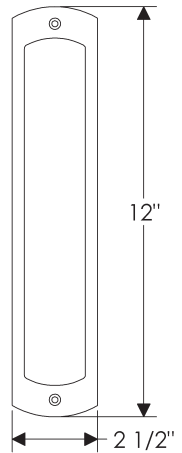

FP252 Flush Pull — Curved

2 1/2" x 12" \$211



FP512

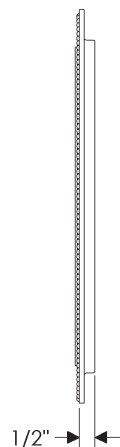
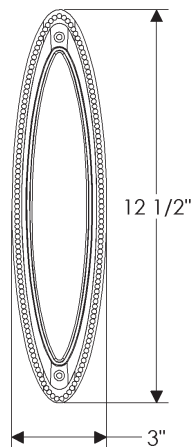

FP512 Flush Pull — Maddox

3" x 12 1/2" \$285

- Specify metal and patina.

Flush Pulls



FP025

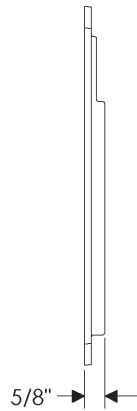
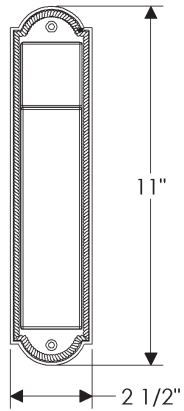

FP025 Flush Pull — Ellis

2 1/2" x 11" \$ 258

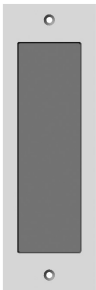

FP105

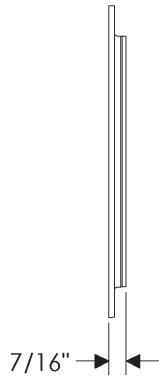
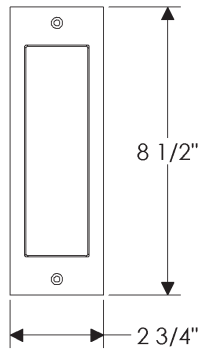

FP105 Flush Pull — Designer

2 3/4" x 8 1/2" \$ 458

- Requires leather or texture selection.

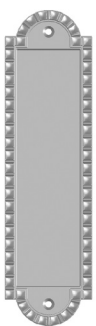

FP30600

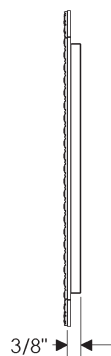
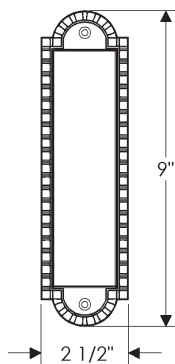

FP30600 Flush Pull — Corbel Arched

2 1/2" x 9" \$ 258

- Specify metal and patina.

Flush Pulls

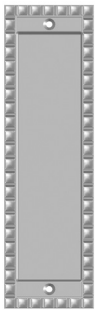

FP30700

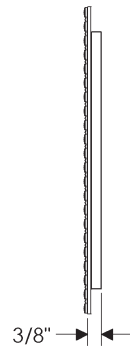
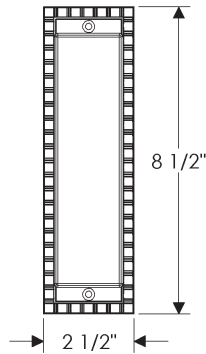

FP30700 Flush Pull — Corbel Rectangular
 2 1/2" x 8 1/2" \$ 258

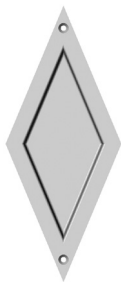

FP359

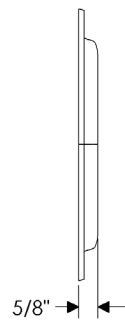
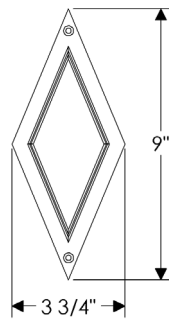

FP359 Flush Pull — Diamond
 3 3/4" x 9" \$ 201



FP10010

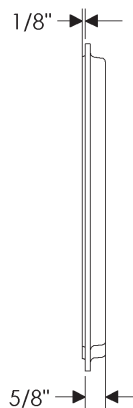
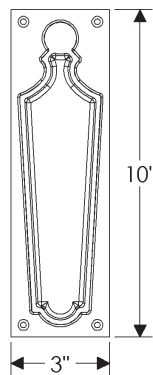

FP10010 Flush Pull — Paris
Roger Thomas Collection
 3" x 10" \$ 238

- Specify metal and patina.

Flush Pulls



FP410

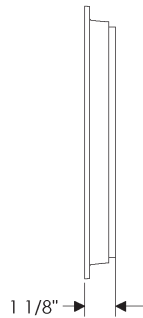
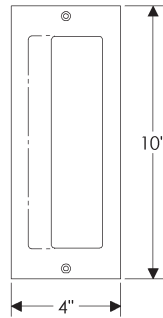

FP410 Flush Pull — Flush Pull with cover

4" x 10" \$ 520

- Specify metal and patina.

Slide Fold

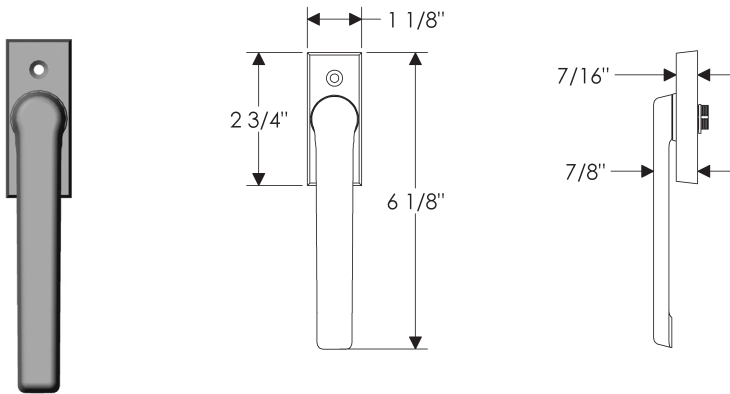

BF100 Slide Fold

1 1/8" x 2 3/4" \$440
 • Includes 7mm spindle.

Edge Pulls

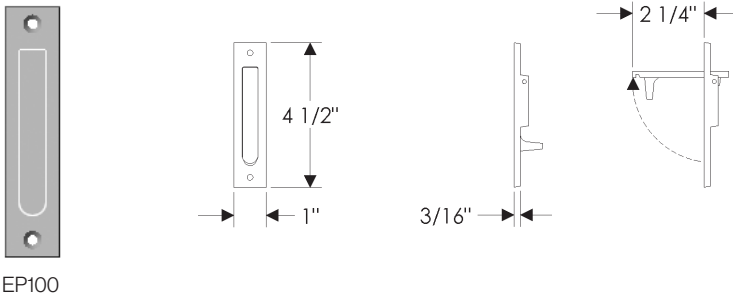

EP100

EP100 Edge Pull

1" x 4 1/2" \$99

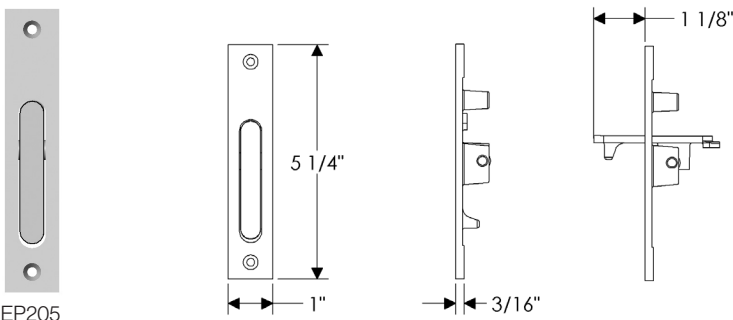

EP205

EP205 Edge Pull

1" x 5 1/4" \$198

- Specify metal, patina, and door thickness.

PDL Pocket Door Lock

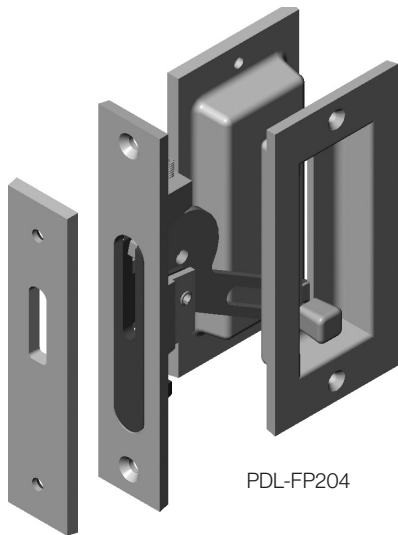

PDL-FP204

PDL Pocket Door Lock

with FP204 Flush Pull — Rectangular	
2" x 4 1/4"	\$ 480
with FP206 Flush Pull — Rectangular	
2 1/4" x 6"	\$ 541
with FP208 Flush Pull — Rectangular	
2 1/2" x 8"	\$ 600
with FP210 Flush Pull — Rectangular	
2 1/2" x 10"	\$ 693
with FP249 Flush Pull — Curved	
2 1/2" x 9"	\$ 637
with FP252 Flush Pull — Curved	
2 1/2" x 12"	\$ 737
with FP259 Flush Pull — Arched	
2 1/2" x 9"	\$ 637
with FP253 Flush Pull — Arched	
2 1/2" x 11"	\$ 726

•FP204 maximum backset 2 1/2"
 * Backset limitations are 1 7/8"–3".
 (Note exceptions for FP204).

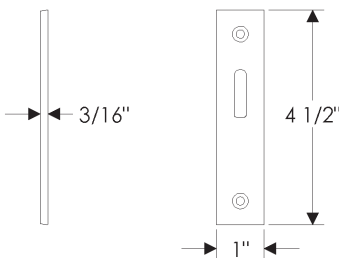
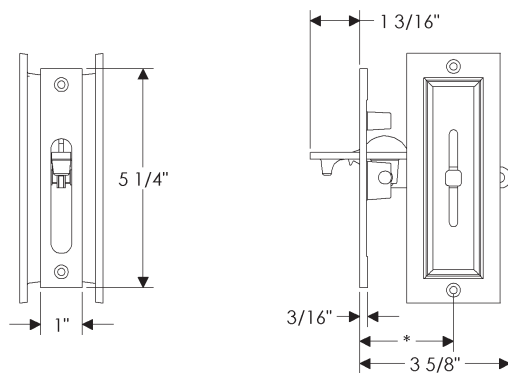

- Specify metal, patina, backset, door thickness, and lock type.
- Available in 2 3/8" or 2 3/4" backsets.
- Works with door thicknesses of 1 3/4" or greater.
- Shown with FP308

PDL Pocket Door Lock

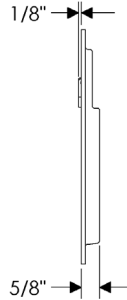
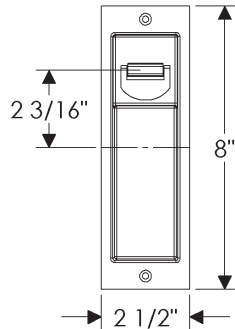
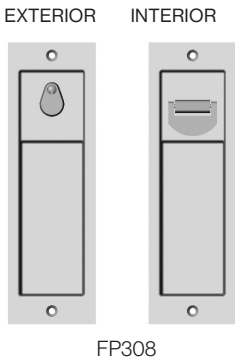

PDL Pocket Door Lock with FP308 2 1/2" x 8"

Privacy.....	\$ 996
Patio	\$ 952
Full Dummy	\$ 464

Refer to spec page I62

with FP025 2 1/2" x 11" Ellis (not shown)

Privacy.....	\$ 1,225
Patio	\$ 1,181
Full Dummy	\$ 690

Refer to spec page I69

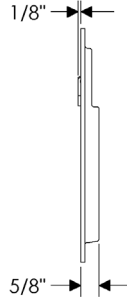
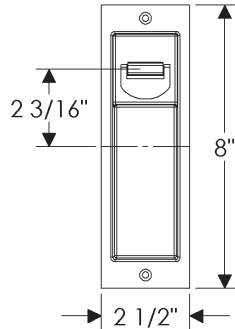
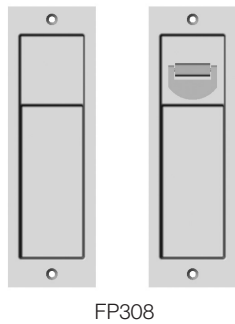

- PDL sets include Accurate 161PDL latch, Accurate 161PDP pocket door pull, and TP25 turn piece
- Dummy Sets include Accurate 161PDP pocket door pull.
- Note 161PDP pocket door pull is 7/8" thick. Do not locate between flush pulls on doors less than 2 1/8" thick.
- Note turn piece projects beyond face of flush pull. Confirm compatibility.

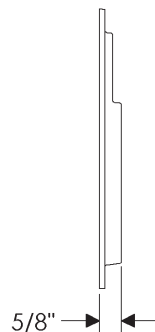
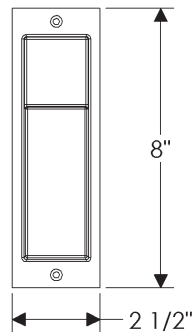
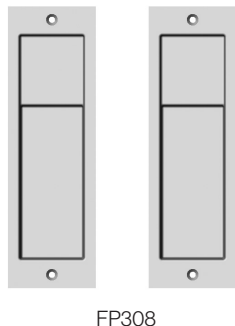

- See Flush Pull specifications for full details.
- Specify metal, patina, and door thickness.
- Works with door thicknesses of 13/4" or greater.

SDL Sliding Door Lock — Passage Function

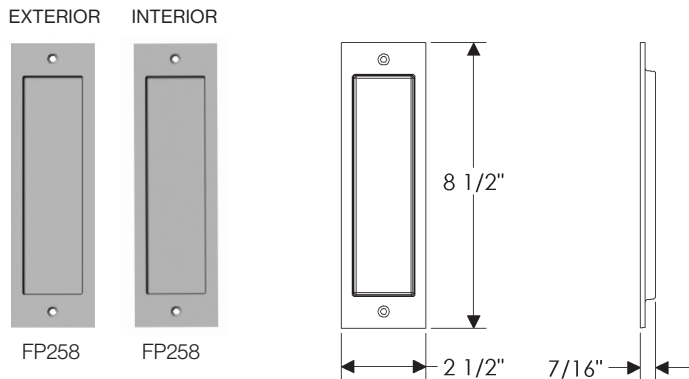

**PD-PA Sliding Door Lock
Passage Function**

with FP258 Flush Pull — Rectangular	
2 1/2" x 8 1/2"	\$ 743
with FP269 Flush Pull — Arched	
2 1/2" x 9"	\$ 743
with FP268 Flush Pull — Rectangular	
2 1/2" x 10"	\$ 833
with FP270 Flush Pull — Arched	
2 1/2" x 11"	\$ 865
with FP262 Flush Pull — Rectangular	
2 1/2" x 13"	\$ 887
with FP512 Flush Pull — Maddox	
3" x 12 1/2"	\$ 1,028
with FP30600 Flush Pull — Corbel Arched	
2 1/2" x 9"	\$ 972
with FP30700 Flush Pull — Corbel Rectangular	
2 1/2" x 8 1/2"	\$ 972

- Includes (2) Flush Pulls
- Includes Accurate 2002 CPDP Pull.

- Available with Flush Pulls FP258, FP269, FP268 or FP270. See Flush Pull specifications for full details.
- Specify metal, patina, backset, door thickness, and lock type.
- Prices are for 2 1/2" or 2 3/4" backsets. Additional charge for narrower and larger backsets (3 3/4", 5", or 6").
- Works with door thicknesses of 1 3/4" or greater.
- Sliding door passage function available. Supplied with Accurate 2002 CPDP Pull. Call for pricing.

SDL Sliding Door Lock — Patio Function

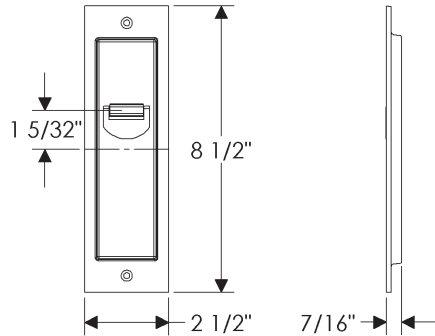
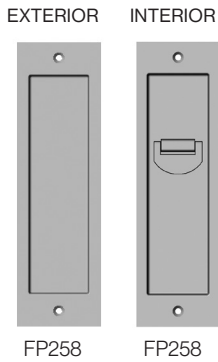

- SDL-S-PO Sliding Door Lock**
Patio Function
- with FP258 Flush Pull — Rectangular
 2 1/2" x 8 1/2" \$ 799
 - with FP269 Flush Pull — Arched
 2 1/2" x 9" \$ 799
 - with FP268 Flush Pull — Rectangular
 2 1/2" x 10" \$ 890
 - with FP270 Flush Pull — Arched
 2 1/2" x 11" \$ 923
- Includes (2) Flush Pulls
 - Includes Accurate 2002 CPDL Lock/Pull and TP25 turn piece

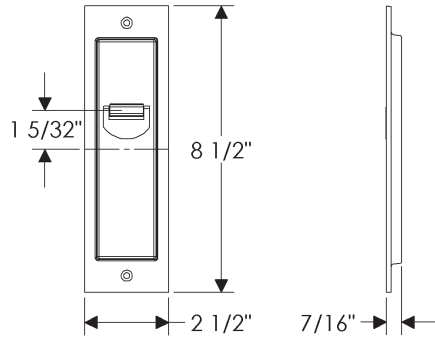
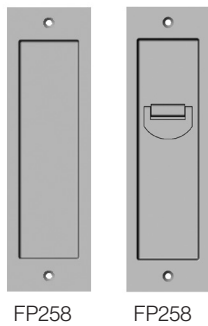

- SDL-D-PO Sliding Door Lock**
Double Door Patio Function
- with FP258 Flush Pull — Rectangular
 2 1/2" x 8 1/2" \$1,403
 - with FP269 Flush Pull — Arched
 2 1/2" x 9" \$1,403
 - with FP268 Flush Pull — Rectangular
 2 1/2" x 10" \$1,583
 - with FP270 Flush Pull — Arched
 2 1/2" x 11" \$1,648
- Includes (4) Flush Pulls
 - Includes Accurate 2002 CPDL Lock/Pull, 2002 CPDS Strike/Pull and TP25 turn piece

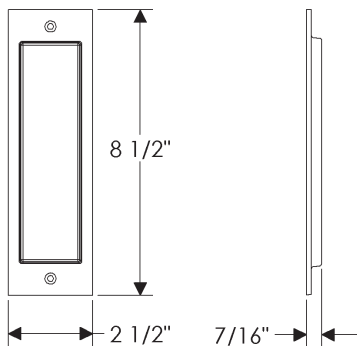
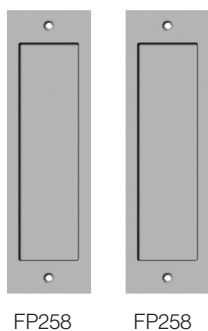

- Available with Flush Pulls FP258, FP269, FP268 or FP270. See Flush Pull specifications for full details.
- Specify metal, patina, backset, door thickness, and lock type.
- Prices are for 2 1/2" or 2 3/4" backsets. Additional charge for narrower and larger backsets (3 3/4", 5", or 6").
- Works with door thicknesses of 1 3/4" or greater.
- Sliding door passage function available. Supplied with Accurate 2002 CPDP Pull. Call for pricing.

SDL Sliding Door Lock — Privacy Function

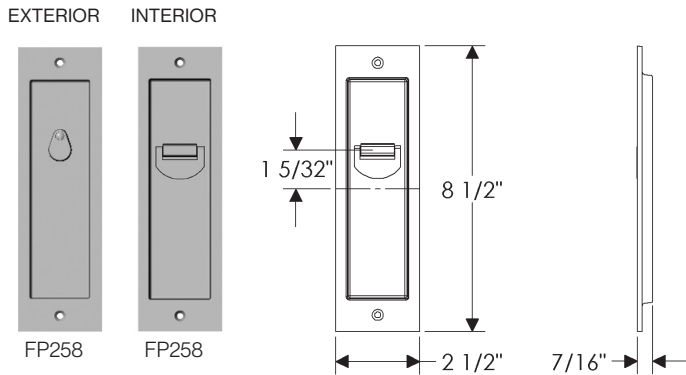

**SDL-S-PR Sliding Door Lock
Privacy Function**

- with FP258 Flush Pull — Rectangular**
2 1/2" x 8 1/2" \$ 811
- with FP269 Flush Pull — Arched**
2 1/2" x 9" \$ 811
- with FP268 Flush Pull — Rectangular**
2 1/2" x 10" \$ 902
- with FP270 Flush Pull — Arched**
2 1/2" x 11" \$ 935

- Includes (2) Flush Pulls
- Includes Accurate 2002 CPDL Lock/Pull and TP25 turn piece

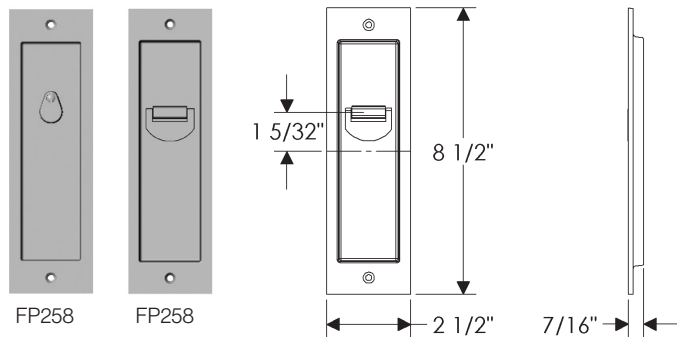

**SDL-D-PR Sliding Door Lock
Double Door Privacy Function**

- with FP258 Flush Pull — Rectangular**
2 1/2" x 8 1/2" \$ 1,415
- with FP269 Flush Pull — Arched**
2 1/2" x 9" \$ 1,415
- with FP268 Flush Pull — Rectangular**
2 1/2" x 10" \$ 1,595
- with FP270 Flush Pull — Arched**
2 1/2" x 11" \$ 1,660

- Includes (4) Flush Pulls
- Includes Accurate 2002 CPDL Lock/Pull, 2002 CPDS Strike/Pull and TP25 turn piece

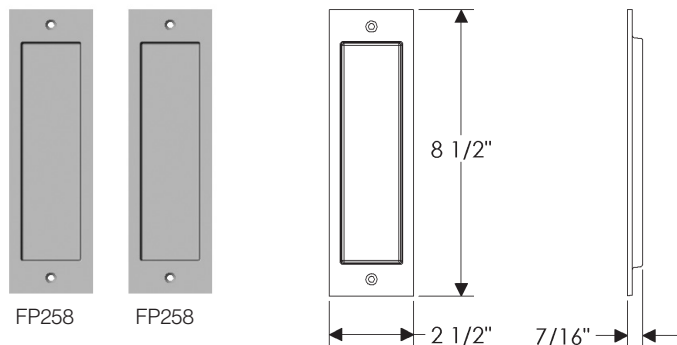

- Available with Flush Pulls FP258, FP269, FP268 or FP270. See Flush Pull specifications for full details.
- Specify metal, patina, backset, door thickness, and lock type.
- Prices are for 2 1/2" or 2 3/4" backsets. Additional charge for narrower and larger backsets (3 3/4", 5", or 6").
- Works with door thicknesses of 1 3/4" or greater.
- Sliding door passage function available. Supplied with Accurate 2002 CPDP Pull. Call for pricing.

SDL Sliding Door Lock — Entry Function

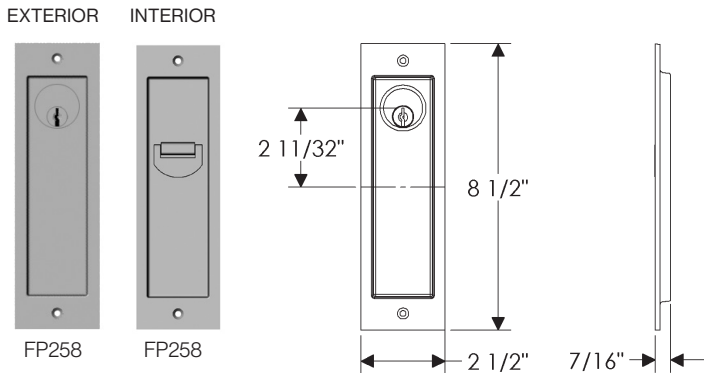

**SDL-S-EN Sliding Door Lock
Entry Function**

- with FP258 Flush Pull — Rectangular**
2 1/2" x 8 1/2" \$901
- with FP269 Flush Pull — Arched**
2 1/2" x 9" \$901
- with FP268 Flush Pull — Rectangular**
2 1/2" x 10" \$992
- with FP270 Flush Pull — Arched**
2 1/2" x 11" \$1,023

- Includes (2) Flush Pulls
- Includes Accurate 2002 CPDL Lock/Pull, TP25 turn piece, and lock cylinder

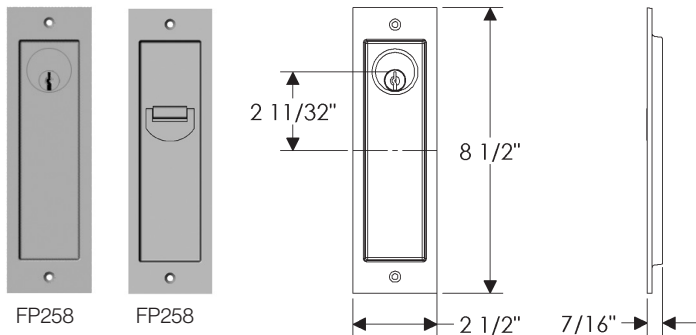

**SDL-D-EN Sliding Door Lock
Double Door Entry Function**

- with FP258 Flush Pull — Rectangular**
2 1/2" x 8 1/2" \$1,503
- with FP269 Flush Pull — Arched**
2 1/2" x 9" \$1,503
- with FP268 Flush Pull — Rectangular**
2 1/2" x 10" \$1,685
- with FP270 Flush Pull — Arched**
2 1/2" x 11" \$1,748

- Includes (4) Flush Pulls
- Includes Accurate 2002 CPDL Lock/Pull, 2002 CPDS strike/pull, TP25 turn piece, and lock cylinder

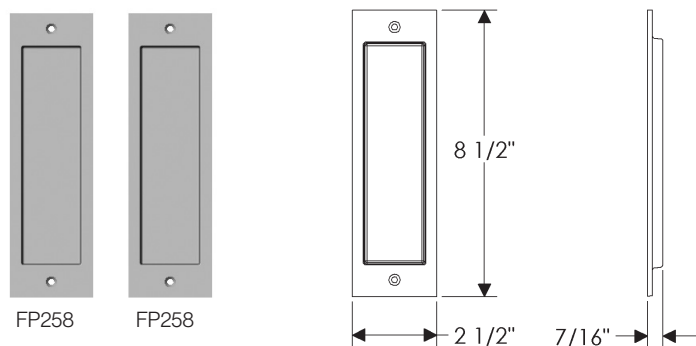

- Price includes FP30700 Corbel Rectangular Flush Pull, as shown, or FP30600 Corbel Arched Flush Pull. See page I69 or I70 for specifications.
- Specify metal, patina, backset, door thickness, and lock type.
- Prices are for 2 1/2" or 2 3/4" backsets. Additional charge for narrower and larger backsets (3 3/4", 5", or 6").
- Works with door thicknesses of 1 3/4" or greater.
- Sliding door passage function available. Supplied with Accurate 2002 CPDP Pull. Call for pricing.

SDL Sliding Door Lock — Patio Function

EXTERIOR INTERIOR

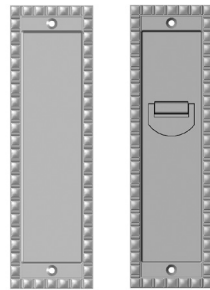

FP30700 FP30700

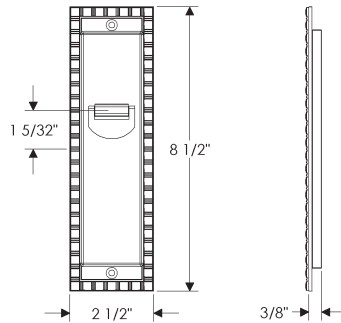

SDL-S-PO Sliding Door Lock

- Patio Function \$1,029
- FP30700 Corbel Rectangular Flush Pulls (2)
2 1/2" x 8 1/2"
 - Includes Accurate 2002 CPDL Lock/Pull and TP25 turn piece

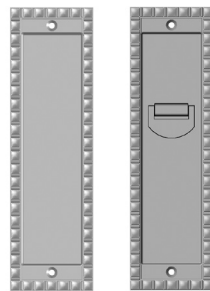

FP30700 FP30700

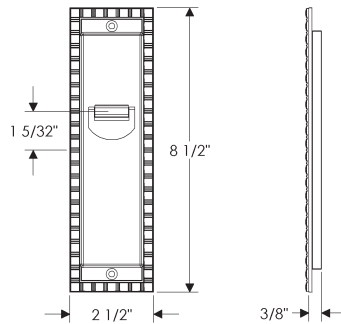

SDL-D-PO Sliding Door Lock

- Double Door Patio Function \$1,859
- FP30700 Corbel Rectangular Flush Pulls (4)
2 1/2" x 8 1/2"
 - Includes Accurate 2002 CPDL Lock/Pull, 2002 CPDS Strike/Pull and TP25 turn piece

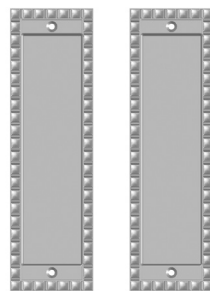

FP30700 FP30700

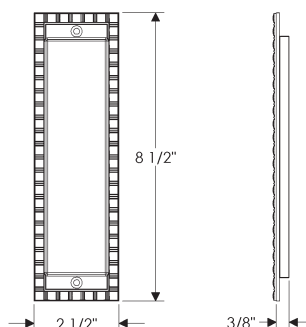

- Price includes FP30700 Corbel Rectangular Flush Pull, as shown, or FP30600 Corbel Arched Flush Pull. See page I69 or I70 for specifications.
- Specify metal, patina, backset, door thickness, and lock type.
- Prices are for 2 1/2" or 2 3/4" backsets. Additional charge for narrower and larger backsets (3 3/4", 5", or 6").
- Works with door thicknesses of 1 3/4" or greater.
- Sliding door passage function available. Supplied with Accurate 2002 CPDP Pull. Call for pricing.

SDL Sliding Door Lock — Privacy Function

EXTERIOR INTERIOR

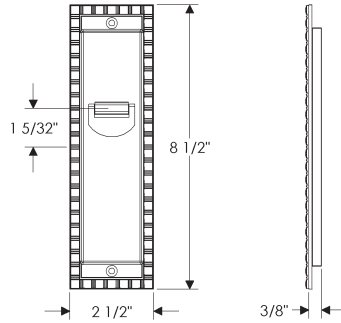
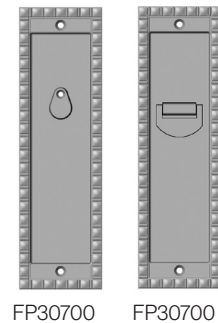

SDL-S-PR Sliding Door Lock

- Privacy Function \$1,039
- FP30700 Corbel Rectangular Flush Pulls (2)
2 1/2" x 8 1/2"
 - Includes Accurate 2002 CPDL Lock/Pull and TP25 turn piece

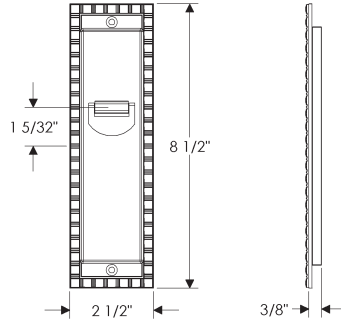
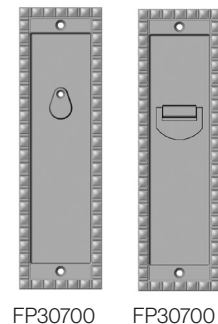

SDL-D-PR Sliding Door Lock

- Double Door Privacy Function \$1,872
- FP30700 Corbel Rectangular Flush Pulls (4)
2 1/2" x 8 1/2"
 - Includes Accurate 2002 CPDL Lock/Pull, 2002 CPDS Strike/Pull and TP25 turn piece

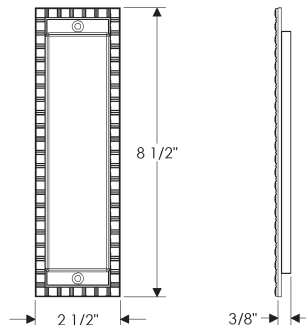
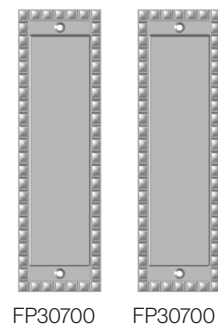

- Price includes FP30700 Corbel Rectangular Flush Pull, as shown, or FP30600 Corbel Arched Flush Pull. See page I69 or I70 for specifications.
- Specify metal, patina, backset, door thickness, and lock type.
- Prices are for 2 1/2" or 2 3/4" backsets. Additional charge for narrower and larger backsets (3 3/4", 5", or 6").
- Works with door thicknesses of 1 3/4" or greater.
- Sliding door passage function available. Supplied with Accurate 2002 CPDP Pull. Call for pricing.

SDL Sliding Door Lock — Entry Function

EXTERIOR INTERIOR

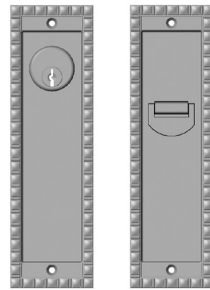

FP30700 FP30700

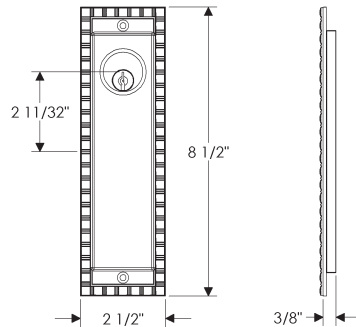

SDL-S-EN Sliding Door Lock

Entry Function \$1,129

- FP30700 Rectangular Flush Pulls (2)
2 1/2" x 8 1/2"
- Includes Accurate 2002 CPDL Lock/Pull, TP25 turn piece, and lock cylinder

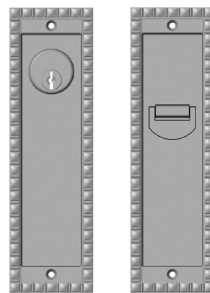

FP30700 FP30700

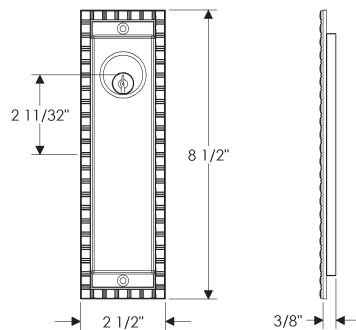

SDL-D-EN Sliding Door Lock

Double Door Entry Function \$1,960

- FP30700 Rectangular Flush Pulls (4)
2 1/2" x 8 1/2"
- Includes Accurate 2002 CPDL Lock/Pull, 2002 CPDS strike/pull, TP25 turn piece, and lock cylinder

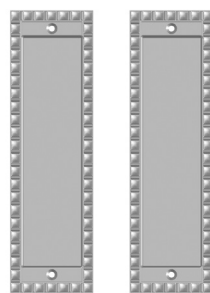

FP30700 FP30700

