

**Sample Order / Cheat Sheet**  
H Multi-Point Sets 1/3

QUOTE     ORDER

NAME: \_\_\_\_\_  
ADDRESS: \_\_\_\_\_  
OFFICE PHONE: \_\_\_\_\_  
FAX PHONE: \_\_\_\_\_  
JOB PHONE: \_\_\_\_\_

PO# \_\_\_\_\_  
DELIVERY: \_\_\_\_\_  
ADDRESS: \_\_\_\_\_

**ROCKY MOUNTAIN®**  
HARDWARE WORK ORDER  
Toll Free 888.788.2013 or 208.788.2013; Fax 208.788.2577

ORDER DATE: \_\_\_\_\_  
CONTACT: \_\_\_\_\_  
JOB NAME: \_\_\_\_\_

2002 12 04

LINE NO.	FUNCTION	HANDLE		ESCUTCHEON		METAL	PATINA	HANDING OR LENGTH	BACKSET	DOOR THICKNESS	LOCK TYPE	DEAD BOLT TRIM	DESCRIPTION	LOCATION #	QTY.	PRICE QUOTED
		EXTERIOR	INTERIOR	EXTERIOR	INTERIOR											
1	EU-PO	L105	L105	E452	E458	B	L	R	2	134	AM		92mm	#25 A	1	\$ 816
2	EU-EN	L105	L105	E459	E458	B	L	L	2	134	AM		92mm	#35B	1	\$ 872
3	EU-EN	L117	L117	E748	E748	W	L	R	2	134	PR		85mm	#30	1	\$ 1007
4	EU-PO	L117	L117	E746	E748	W	L	L	2	134	PR		85mm	#30	1	\$ 929
5	EU-DU	L117	L117	E746	E746	W	L	L						#31	1	\$ 697
6	EU-PA	L105	L105	E452	E452	B	L	R	2	134	AM			#25	1	\$ 762

**FUNCTION**  
EU-DU = Dummy  
EU-EN = Multi-Point Entry  
EU-PA = Multi-Point Passage  
EU-PO = Multi-Point Patio

**HANDLE**  
For a list of Levers available for Multi-Point Door Sets, see next page.  
For specifications, refer to Section A.

**ESCUTCHEONS**  
For a list of Escutcheons available for Multi-Point Door Sets, see next page.  
For configurations, specifications, and pricing, refer to content of this section.

**METAL**  
B = Silicon Bronze  
W = White Bronze

**PATINA**  
L = Light  
M = Medium  
D = Dark  
R = Rust  
BB = Brushed  
DL = Dark Lustre  
HP = High Polished \*  
\*Up-charge applies.

**HANDING**  
See Hinged Door Handing diagram, next page.  
L = Left Hand  
R = Right Hand  
LR = Left Hand Reverse  
RR = Right Hand Reverse

**BACKSET**  
No lock mechanisms are provided with these sets. Backset information is needed to verify compatibility of trim with the existing door conditions.

**DOOR THICKNESS**  
138 = 13/8"  
112 = 11/2"  
134 = 13/4"  
178 = 17/8"  
2 = 2"  
214 = 2 1/4"  
  
Up-charge for sizes below.  
Call for pricing.  
212 = 2 1/2"  
258 = 2 5/8"  
234 = 2 3/4"  
3 = 3"  
314 = 3 1/4"  
312 = 3 1/2"  
4 = 4"  
N = No

**LOCK TYPE**  
AM = American Cylinder Lock  
PR = Profile Cylinder Lock

**DEAD BOLT TRIM**  
Not Applicable

**DESCRIPTION**  
Center to Center Dimension  
Lever to Cylinder  
  
Edge Collection Options  
ETW = Weave  
EWD = Wood  
EBA = Basic  
ETD = Tide  
EWR = Wire  
EMS = Mooncape

**QTY**  
Number of each desired

**PRICE**  
\$ List price each

**LOCATION #**  
Room Number or Door Number, etc.

**Sample Order / Cheat Sheet**

H Multi-Point Sets

2/3

**HANDLE****Levers**

L075 = Ellis Lever  
 L101 = Longhorn Lever  
 L102 = Squirrel Tail Lever  
 L103 = Chub Lever  
 L104 = Hook Lever  
 L105 = Beaver Tail Lever  
 L106 = Talon Lever  
 L107 = Slugger Lever  
 L108 = Tube Lever  
 L109 = Legacy Lever  
 L110 = Classic Lever  
 L111 = Twig Lever  
 L112 = Large Chub Lever  
 L113 = Carriage Lever  
 L115 = Acanthus Lever  
 L116 = Herron Lever  
 L117 = French Lever  
 L118 = French Twist Lever  
 L119 = Long Legacy Lever  
 L120 = Long French Lever  
 L121 = Rock Creek Lever  
 L122 = Large Hook Lever  
 L123 = Old World Lever  
 L125 = Classic Scroll Lever  
 L126 = Triple Twist Lever  
 L127 = Scroll Lever  
 L128 = Small Classic Lever  
 L129 = Trundle Lever  
 L130 = Monarch Lever  
 L132 = Square Twist Lever  
 L135 = Olympus Lever  
 L137 = Olympus Return Lever  
 L140 = Harrington Lever  
 L141 = Large Rock Creek Lever  
 L150 = Bella Lever  
 L151 = Large Harrington Lever  
 L152 = Osprey Lever  
 L153 = Talon Return Lever  
 L154 = Stalk Lever  
 L156 = Large Classic Scroll Lever  
 L158 = Large Acanthus Lever  
 L159 = Baton Lever  
 L160 = Wing Lever  
 L163 = Euro Lever  
 L164 = Chiseled Lever  
 L174 = Lariat Lever  
 L175 = Bamboo Lever  
 L179 = Twig Return Lever  
 L182 = Ribbon & Reed Lever  
 L185 = Ore Lever  
 L216 = Old World Return Lever  
 L219 = Long Legacy Return Lever  
 L224 = Ridge Lever

**Levers (continued)**

L228 = Large Ridge Lever  
 L241 = Large French Lever  
 L245 = French Return Lever  
 L260 = Trolley Lever  
 L261 = Rail Lever  
 L265 = I Beam Lever  
 L267 = Cross Lever  
 L276 = Falcon Lever  
 L301 = Strap Lever  
 L303 = Boiler Lever  
 L304 = Reed Lever  
 L307 = Jane Lever  
 L308 = Long Jane Lever  
 L310 = Pool Lever  
 L311 = Blade Lever  
 L314 = UJ Lever  
 L330 = Coupler Lever  
 L580 = Maddox Lever  
 L10010 = Paris Lever  
 L10015 = Flute Lever  
 L10801 = Briggs Lever  
 L10802 = Kettle Lever  
 L20230 = Shift Lever  
 L21005 = Emile Lever  
 L30140 = Smith Lever  
 L30142 = Whittle Lever  
 L30160 = Crown Lever  
 L30161 = Capitol Lever  
 L30180 = Chateau Lever  
 L30301 = Trousdale Lever

**ESUTCHEONS****Arched**

E786 = 13/8" x 11" Arched (LLO)  
 E788 = 13/8" x 11" Arched (LLO)(AM)  
 E787 = 13/8" x 11" Arched (LLO)(TP)  
 E718 = 13/8" x 11" Arched (LHi)  
 E719 = 13/8" x 11" Arched (LHi)(PR)  
 E789 = 13/8" x 11" Arched (LHi)(AM)  
 E785 = 13/8" x 11" Arched (LHi)(TP)  
 E776 = 13/4" x 10" Arched (LLO)  
 E775 = 13/4" x 10" Arched (LLO)(AM)  
 E777 = 13/4" x 10" Arched (LLO)(TP)  
 E746 = 13/4" x 11" Arched (LHi)  
 E748 = 13/4" x 11" Arched (LHi)(PR)  
 E745 = 13/4" x 11" Arched (LHi)(AM)  
 E747 = 13/4" x 11" Arched (LHi)(TP)  
 E741 = 13/4" x 11" Arched (LLO)  
 E743 = 13/4" x 11" Arched (LLO)(AM)  
 E742 = 13/4" x 11" Arched (LLO)(TP)  
 E751 = 2 1/2" x 11" Arched (LHi)  
 E754 = 2 1/2" x 11" Arched (LHi)(PR)  
 E750 = 2 1/2" x 11" Arched (LHi)(AM)

**Arched (continued)**

E753 = 2 1/2" x 11" Arched (LHi)(TP)  
 E755 = 2 1/2" x 11" Arched (LLO)  
 E757 = 2 1/2" x 11" Arched (LLO)(AM)  
 E756 = 2 1/2" x 11" Arched (LLO)(TP)

**Bordeaux**

E30865 = 2" x 17" Bordeaux (LHi)  
 E30868 = 2" x 17" Bordeaux (LHi)(PR)  
 E30867 = 2" x 17" Bordeaux (LHi)(AM)  
 E30866 = 2" x 17" Bordeaux (LHi)(TP)  
 E30861 = 2" x 17" Bordeaux (LLO)  
 E30863 = 2" x 17" Bordeaux (LLO)(AM)  
 E30862 = 2" x 17" Bordeaux (LLO)(TP)

**Briggs**

E10871 = 2" x 15" Briggs (LHi)  
 E10873 = 2" x 15" Briggs (LHi)(PR)  
 E10870 = 2" x 15" Briggs (LHi)(AM)  
 E10872 = 2" x 15" Briggs (LHi)(TP)  
 E10874 = 2" x 15" Briggs (LLO)  
 E10875 = 2" x 15" Briggs (LLO)(AM)  
 E10876 = 2" x 15" Briggs (LLO)(TP)

**Convex**

E30565 = 13/4" x 11" Convex (LHi)  
 E30568 = 13/4" x 11" Convex (LHi)(PR)  
 E30567 = 13/4" x 11" Convex (LHi)(AM)  
 E30566 = 13/4" x 11" Convex (LHi)(TP)  
 E30561 = 13/4" x 11" Convex (LLO)  
 E30563 = 13/4" x 11" Convex (LLO)(AM)  
 E30562 = 13/4" x 11" Convex (LLO)(TP)

**Corbel Arched**

E30665 = 2" x 11" Corbel (LHi)  
 E30668 = 2" x 11" Corbel (LHi)(PR)  
 E30667 = 2" x 11" Corbel (LHi)(AM)  
 E30666 = 2" x 11" Corbel (LHi)(TP)  
 E30661 = 2" x 11" Corbel (LLO)  
 E30663 = 2" x 11" Corbel (LLO)(AM)  
 E30662 = 2" x 11" Corbel (LLO)(TP)

**Corbel Rectangular**

E30765 = 2" x 11" Corbel (LHi)  
 E30768 = 2" x 11" Corbel (LHi)(PR)  
 E30767 = 2" x 11" Corbel (LHi)(AM)  
 E30766 = 2" x 11" Corbel (LHi)(TP)  
 E30761 = 2" x 11" Corbel (LLO)  
 E30763 = 2" x 11" Corbel (LLO)(AM)  
 E30762 = 2" x 11" Corbel (LLO)(TP)

**Curved**

E576 = 13/8" x 11" Curved (LHi)  
 E575 = 13/8" x 11" Curved (LHi)(PR)  
 E577 = 13/8" x 11" Curved (LHi)(AM)  
 E527 = 13/8" x 11" Curved (LLO)  
 E528 = 13/8" x 11" Curved (LLO)(TP)

**Curved (continued)**

E530 = 13/4" x 11" Curved (LHi)  
 E532 = 13/4" x 11" Curved (LHi)(PR)  
 E538 = 13/4" x 11" Curved (LHi)(AM)  
 E536 = 13/4" x 11" Curved (LHi)(TP)  
 E531 = 13/4" x 11" Curved (LLO)  
 E539 = 13/4" x 11" Curved (LLO)(AM)  
 E537 = 13/4" x 11" Curved (LLO)(TP)

**Edge**

E195 = 13/4" x 11" Edge (LHi)  
 E198 = 13/4" x 11" Edge (LHi)(PR)  
 E197 = 13/4" x 11" Edge (LHi)(AM)  
 E196 = 13/4" x 11" Edge (LHi)(TP)  
 E191 = 13/4" x 11" Edge (LLO)  
 E193 = 13/4" x 11" Edge (LLO)(AM)  
 E192 = 13/4" x 11" Edge (LLO)(TP)

**Ellis**

E041 = 13/4" x 11" Ellis (LHi)  
 E046 = 13/4" x 11" Ellis (LHi)(PR)  
 E045 = 13/4" x 11" Ellis (LHi)(AM)  
 E043 = 13/4" x 11" Ellis (LHi)(TP)  
 E040 = 13/4" x 11" Ellis (LLO)  
 E044 = 13/4" x 11" Ellis (LLO)(AM)  
 E042 = 13/4" x 11" Ellis (LLO)(TP)

**Fleur de Lis**

E824 = 2" x 15" Fleur de Lis (LHi)  
 E825 = 2" x 15" Fleur de Lis (LHi)(PR)  
 E826 = 2" x 15" Fleur de Lis (LHi)(AM)  
 E827 = 2" x 15" Fleur de Lis (LHi)(TP)  
 E817 = 2" x 15" Fleur de Lis (LLO)  
 E819 = 2" x 15" Fleur de Lis (LLO)(AM)  
 E818 = 2" x 15" Fleur de Lis (LLO)(TP)

**Hammered**

E30465 = 13/4" x 11" Hammered (LHi)  
 E30468 = 13/4" x 11" Hammered (LHi)(PR)  
 E30467 = 13/4" x 11" Hammered (LHi)(AM)  
 E30466 = 13/4" x 11" Hammered (LHi)(TP)  
 E30461 = 13/4" x 11" Hammered (LLO)  
 E30463 = 13/4" x 11" Hammered (LLO)(AM)  
 E30462 = 13/4" x 11" Hammered (LLO)(TP)

*(Escutcheons continued on next page)***Key**

(LHi) = Lever High  
 (LLO) = Lever Low  
 (AM) = American Cylinder Escutcheon  
 (PR) = Profile Cylinder Escutcheon  
 (TP) = Turn Piece Escutcheon

Note: Designer line utilizes Metro  
 Series plates for Multi-point.

**Sample Order / Cheat Sheet**  
**H Multi-Point Sets**      3/3

**ESCUTCHEONS** *(continued)*

**Mack**

- E21041 = 13/4" x 11" Mack (LHi)
- E21046 = 13/4" x 11" Mack (LHi)(PR)
- E21045 = 13/4" x 11" Mack (LHi)(AM)
- E21043 = 13/4" x 11" Mack (LHi)(TP)
- E21040 = 13/4" x 11" Mack (LLo)
- E21044 = 13/4" x 11" Mack (LLo)(AM)
- E21042 = 13/4" x 11" Mack (LLo)(TP)

**Maddox**

- E591 = 13/4" x 11" Maddox (LHi)
- E592 = 13/4" x 11" Maddox (LHi)(PR)
- E595 = 13/4" x 11" Maddox (LHi)(AM)
- E597 = 13/4" x 11" Maddox (LHi)(TP)
- E590 = 13/4" x 11" Maddox (LLo)
- E594 = 13/4" x 11" Maddox (LLo)(AM)
- E596 = 13/4" x 11" Maddox (LLo)(TP)

**Metro**

- E270 = 13/8" x 11" Metro (LHi)
- E274 = 13/8" x 11" Metro (LHi)(PR)
- E271 = 13/8" x 11" Metro (LHi)(TP)
- E272 = 13/8" x 11" Metro (LLo)
- E273 = 13/8" x 11" Metro (LLo)(TP)
  
- E241 = 13/4" x 11" Metro (LHi)
- E246 = 13/4" x 11" Metro (LHi)(PR)
- E245 = 13/4" x 11" Metro (LHi)(AM)
- E243 = 13/4" x 11" Metro (LHi)(TP)
- E240 = 13/4" x 11" Metro (LLo)
- E244 = 13/4" x 11" Metro (LLo)(AM)
- E242 = 13/4" x 11" Metro (LLo)(TP)

**Rectangular**

- E456 = 13/8" x 11" Rect (LHi)
- E455 = 13/8" x 11" Rect (LHi)(PR)
- E481 = 13/8" x 11" Rect (LHi)(AM)
- E487 = 13/8" x 11" Rect (LHi)(TP)
- E489 = 13/8" x 11" Rect (LLo)
- E486 = 13/8" x 11" Rect (LLo)(AM)
- E488 = 13/8" x 11" Rect (LLo)(TP)
  
- E426 = 13/4" x 10" Rect (LLo)
- E425 = 13/4" x 10" Rect (LLo)(AM)
- E427 = 13/4" x 10" Rect (LLo)(TP)
  
- E446 = 13/4" x 11" Rect (LHi)
- E448 = 13/4" x 11" Rect (LHi)(PR)
- E445 = 13/4" x 11" Rect (LHi)(AM)
- E447 = 13/4" x 11" Rect (LHi)(TP)
- E441 = 13/4" x 11" Rect (LLo)
- E443 = 13/4" x 11" Rect (LLo)(AM)
- E442 = 13/4" x 11" Rect (LLo)(TP)

**Rectangular** *(continued)*

- E451 = 2 1/2" x 11" Rect (LHi)
- E457 = 2 1/2" x 11" Rect (LHi)(PR)
- E450 = 2 1/2" x 11" Rect (LHi)(AM)
- E453 = 2 1/2" x 11" Rect (LHi)(TP)
- E452 = 2 1/2" x 11" Rect (LLo)
- E459 = 2 1/2" x 11" Rect (LLo)(AM)
- E458 = 2 1/2" x 11" Rect (LLo)(TP)

**Stepped**

- E376 = 13/8" x 11" Stepped (LHi)
- E375 = 13/8" x 11" Stepped (LHi)(PR)
- E377 = 13/8" x 11" Stepped (LHi)(TP)
- E327 = 13/8" x 11" Stepped (LLo)
- E328 = 13/8" x 11" Stepped (LLo)(TP)

- E330 = 13/4" x 11" Stepped (LHi)
- E332 = 13/4" x 11" Stepped (LHi)(PR)
- E338 = 13/4" x 11" Stepped (LHi)(AM)
- E336 = 13/4" x 11" Stepped (LHi)(TP)
- E331 = 13/4" x 11" Stepped (LLo)
- E339 = 13/4" x 11" Stepped (LLo)(AM)
- E337 = 13/4" x 11" Stepped (LLo)(TP)

**Trousdale**

- E30365 = 13/4" x 11" Trousdale (LHi)
- E30368 = 13/4" x 11" Trousdale (LHi)(PR)
- E30367 = 13/4" x 11" Trousdale (LHi)(AM)
- E30366 = 13/4" x 11" Trousdale (LHi)(TP)
- E30361 = 13/4" x 11" Trousdale (LLo)
- E30363 = 13/4" x 11" Trousdale (LLo)(AM)
- E30362 = 13/4" x 11" Trousdale (LLo)(TP)

**Key**

- (LHi) = Lever High
- (LLo) = Lever Low
- (AM) = American Cylinder Escutcheon
- (PR) = Profile Cylinder Escutcheon
- (TP) = Turn Piece Escutcheon

Note: Designer line utilizes Metro Series plates for Multi-point.

**Handing**

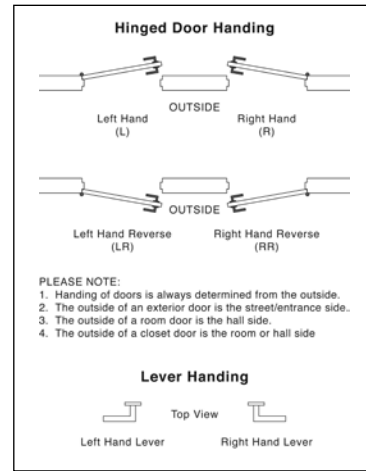

Multi-Point Profile Cylinder Set—Lever to Lever

- 1 Lever
- 2 Escutcheon
- 3 8mm Straight Spindle
- 4 Profile Cylinder
- 5 Turn Piece
- 6 Cylinder Set Screw

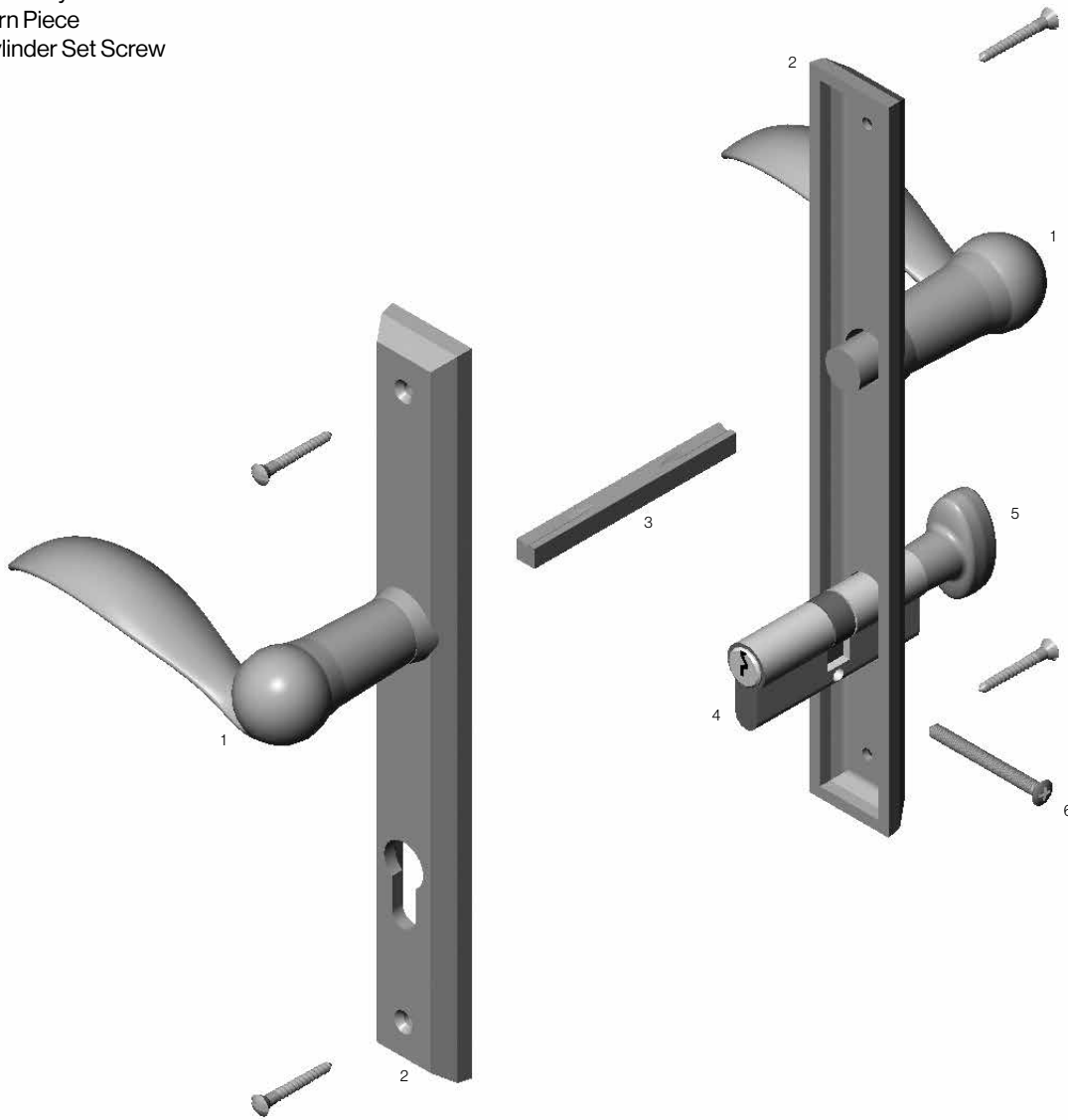

Multi-Point American Cylinder Set—Lever to Lever

- 1 Lever
- 2 Escutcheon
- 3 8mm Straight Spindle
- 4 Turn Piece
- 5 Turn Piece Sleeve
- 6 American Cylinder
- 7 Sex Bolt Machine Screw
- 8 Sex Bolt
- 9 Tail Piece

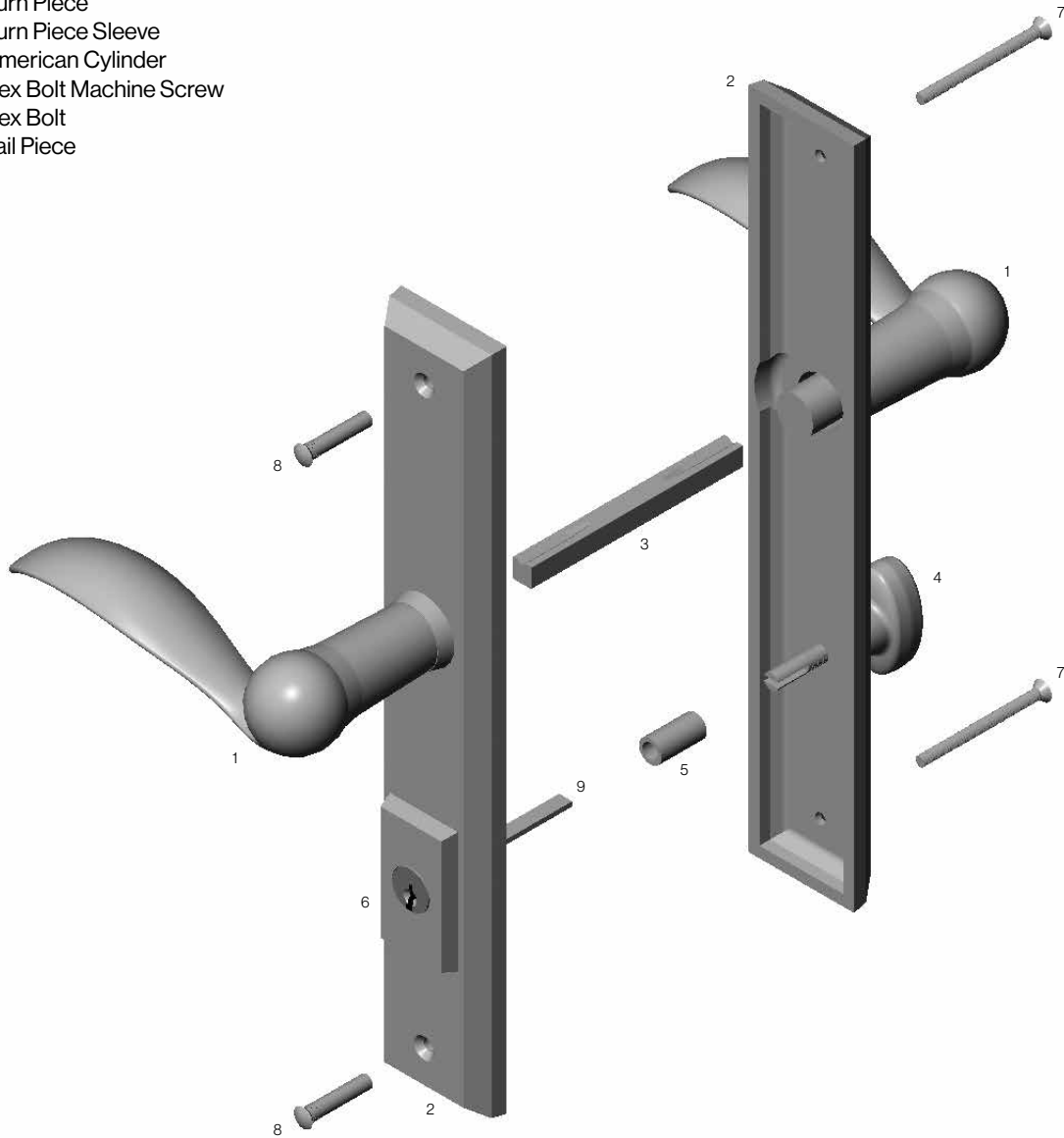

**Multi Point Door Information**

- 1. Manufacture \_\_\_\_\_ (Jeldwen, Marvin, etc.)
- 2. Function \_\_\_\_\_ (Dummy, Patio or Entry)
- 3. Handing \_\_\_\_\_ (From Exterior: L,R,LR,RR)
- 4. French Door - Inactive Panel, Active or Fixed Levers \_\_\_\_\_
- 5. Lever High or Low \_\_\_\_\_
- 6. American Cylinder or Profile Cylinder \_\_\_\_\_ (see Detail A)



(Detail A)

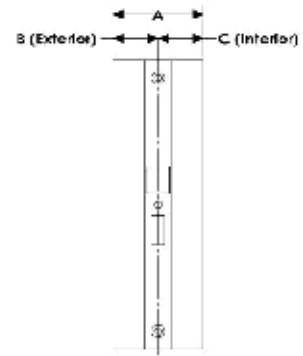

(Detail B)

- 7. Stile Width \_\_\_\_\_ (Inches)
- 8. Back Set \_\_\_\_\_ (Inches)
- 9. Door thickness A: \_\_\_\_\_ (see Detail B)
- 10. Lock Offset B: \_\_\_\_\_ C: \_\_\_\_\_ (see Detail B)
- 11. Hardware projection limitations \_\_\_\_\_ (i.e. for screen door)
- 12. Center to Center \_\_\_\_\_ (see Detail C)
- 13. Mounting hole location:
  - a. Match existing mounting holes?: YES (If yes, select option. See #14)
  - NO (If no, standard RMH spacing will be provided)
- 14. Screw Spacing check box below or supply custom screw spacing (see Detail D)  
(Custom spacing not available with Briggs and Mack)

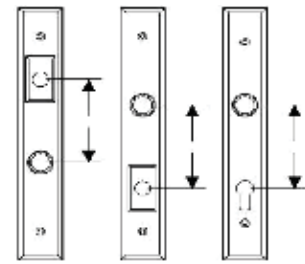

(Detail C)

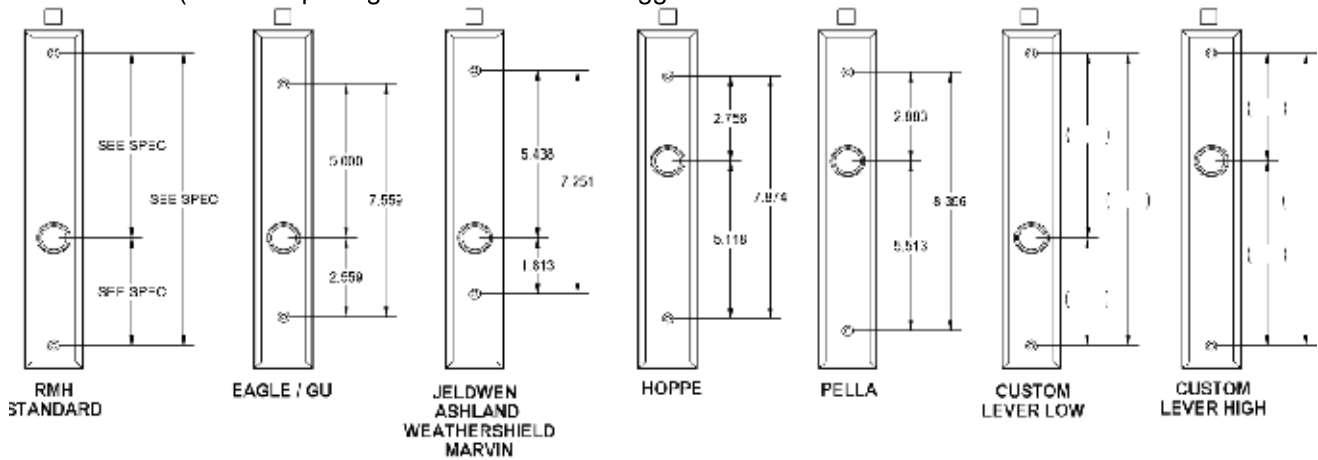

(Detail D)

**Additional Notes:**

Purchase Order \_\_\_\_\_







**Custom trim is non-returnable.**

By signing below, you are confirming the above information is correct and giving Rocky Mountain Hardware approval to match information provided. This sheet will be the approval for the custom hardware you've requested. I have read, understand, approve and take full responsibility by signing below.

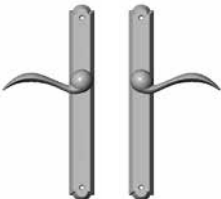
Approval Signature \_\_\_\_\_ Date: \_\_\_\_\_

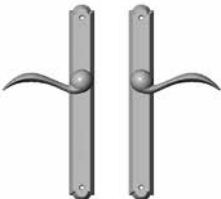

- Price includes your choice of lever. (Knobs and rings are not recommended for multi-point combinations.) Call RMH for pricing.
- Combinations are shown with L105 Beaver Tail Lever for illustrations purposes only. Refer to Section A for desired lever.
- Entry, Patio, and Passage functions include 8mm spindle.
- Specify metal, patina, handing, backset, door thickness, lock type, and center-to-center dimension.
- Refer to Section B for Escutcheon Specifications.

ACTIVE	DUMMY	ESCUTCHEON OPTIONS
<p><b>A</b></p>  <p>E719 E719</p>	 <p>E718 E718</p>	<p><b>A 13/8" x 11" Arched Escutcheon</b>  <b>Profile Cylinder</b>                      E719 / E719 Entry Trim* ..... \$ 976                      E718 / E719 Patio Trim* ..... \$ 899                      E718 / E718 Full Dummy..... \$ 665</p> <ul style="list-style-type: none"> <li>• Entry Trim includes Profile cylinder and turn piece.</li> <li>• Patio Trim includes 1/2 Profile cylinder and turn piece.</li> </ul>
 <p>E718 E719</p>	 <p>E718 E718</p>	<p><b>B 13/8" x 11" Arched Escutcheon</b>  <b>American Cylinder</b>                      E789 / E785 Entry Trim* ..... \$ 907                      E718 / E785 Patio Trim* ..... \$ 781                      E718 / E718 Passage Trim ..... \$ 714                      E718 / E718 Full Dummy..... \$ 665</p> <ul style="list-style-type: none"> <li>• Entry Trim includes American cylinder and turn piece.</li> <li>• Patio Trim includes turn piece.</li> </ul>
<p><b>B</b></p>  <p>E789 E785</p>	 <p>E718 E718</p>	<p>* The center to center dimension will need to be verified before set can be ordered.</p>
 <p>E718 E785</p>	 <p>E718 E718</p>	

- Price includes your choice of lever. (Knobs and rings are not recommended for multi-point combinations.) Call RMH for pricing.
- Combinations are shown with L105 Beaver Tail Lever for illustrations purposes only. Refer to Section A for desired lever.
- Entry, Patio, and Passage functions include 8mm spindle.
- Specify metal, patina, handing, backset, door thickness, lock type, and center-to-center dimension.
- Refer to Section B for Escutcheon Specifications.

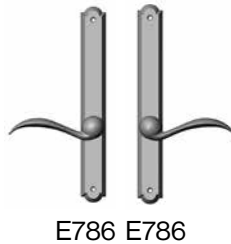
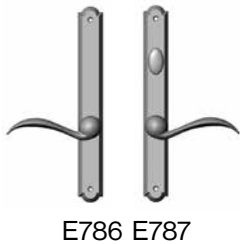
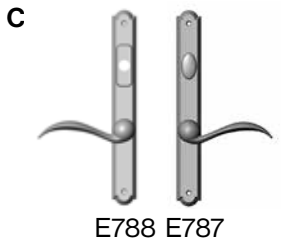

**C 13/8" x 11" Arched Escutcheon**



**American Cylinder**

E788 / E787 Entry Trim*	\$ 907
E786 / E787 Patio Trim*	\$ 781
E786 / E786 Passage Trim	\$ 714
E786 / E786 Full Dummy	\$ 665







- Entry Trim includes American cylinder and turn piece.
- Patio Trim includes turn piece.

\* The center to center dimension will need to be verified before set can be ordered.

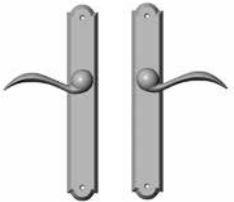

- Price includes your choice of lever. (Knobs and rings are not recommended for multi-point combinations.) Call RMH for pricing.
- Combinations are shown with L105 Beaver Tail Lever for illustrations purposes only. Refer to Section A for desired lever.
- Entry, Patio, and Passage functions include 8mm spindle.
- Specify metal, patina, handing, backset, door thickness, lock type, and center-to-center dimension.
- Refer to Section B for Escutcheon Specifications.

ACTIVE	DUMMY	ESCUTCHEON OPTIONS
<p><b>A</b></p>  <p>E775 E777</p>  <p>E776 E777</p>	 <p>E776 E776</p>	<p><b>A 13/4" x 10" Arched Escutcheon (105 mm c-to-c)</b></p> <p><b>American Cylinder</b></p> <p>E775 / E777 Entry Trim* ..... \$ 872</p> <p>E776 / E777 Patio Trim* ..... \$ 816</p> <p>E776 / E776 Passage Trim..... \$ 762</p> <p>E776 / E776 Full Dummy..... \$ 697</p> <ul style="list-style-type: none"> <li>• Entry Trim includes American cylinder and turn piece.</li> <li>• Patio Trim includes turn piece.</li> </ul> <p>* The center to center dimension will need to be verified before set can be ordered.</p>

- Price includes your choice of lever. (Knobs and rings are not recommended for multi-point combinations.) Call RMH for pricing.
- Combinations are shown with L105 Beaver Tail Lever for illustrations purposes only. Refer to Section A for desired lever.
- Entry, Patio, and Passage functions include 8mm spindle.
- Specify metal, patina, handing, backset, door thickness, lock type, and center-to-center dimension.
- Refer to Section B for Escutcheon Specifications.

	ACTIVE	DUMMY	ESCUTCHEON OPTIONS
<b>A</b>	 <p>E748 E748</p>		<p><b>A 13/4" x 11" Arched Escutcheon</b>  <b>Profile Cylinder</b>                      E748 / E748 Entry Trim* ..... \$ 1,007                      E746 / E748 Patio Trim* ..... \$ 929                      E746 / E746 Full Dummy ..... \$ 697</p> <ul style="list-style-type: none"> <li>• Entry Trim includes Profile cylinder and turn piece.</li> <li>• Patio Trim includes 1/2 Profile cylinder and turn piece.</li> </ul>
	 <p>E746 E748</p>	 <p>E746 E746</p>	
<b>B</b>	 <p>E745 E747</p>		<p><b>B 13/4" x 11" Arched Escutcheon</b>  <b>American Cylinder</b>                      E745 / E747 Entry Trim* ..... \$ 872                      E746 / E747 Patio Trim* ..... \$ 816                      E746 / E746 Passage Trim ..... \$ 762                      E746 / E746 Full Dummy ..... \$ 697</p> <ul style="list-style-type: none"> <li>• Entry Trim includes American cylinder and turn piece.</li> <li>• Patio Trim includes turn piece.</li> </ul> <p>* The center to center dimension will need to be verified before set can be ordered.</p>
	 <p>E746 E747</p>	 <p>E746 E746</p>	

- Price includes your choice of lever. (Knobs and rings are not recommended for multi-point combinations.) Call RMH for pricing.
- Combinations are shown with L105 Beaver Tail Lever for illustrations purposes only. Refer to Section A for desired lever.
- Entry, Patio, and Passage functions include 8mm spindle.
- Specify metal, patina, handing, backset, door thickness, lock type, and center-to-center dimension.
- Refer to Section B for Escutcheon Specifications.

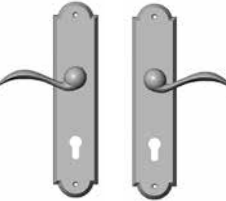
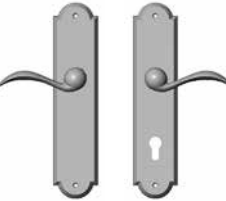
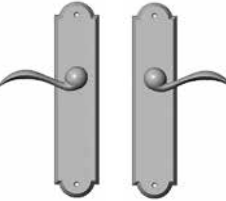
ACTIVE	DUMMY	ESCUTCHEON OPTIONS
<p><b>A</b></p>  <p>E743 E742</p>	<p><b>DUMMY</b></p>  <p>E741 E741</p>	<p><b>A 1 3/4" x 11" Arched Escutcheon</b>  <b>American Cylinder</b>                      E743 / E742 Entry Trim* ..... \$ 872                      E741 / E742 Patio Trim* ..... \$ 816                      E741 / E741 Passage Trim ..... \$ 762                      E741 / E741 Full Dummy ..... \$ 697</p> <ul style="list-style-type: none"> <li>• Entry Trim includes American cylinder and turn piece.</li> <li>• Patio Trim includes turn piece.</li> </ul> <p><b>B 2 1/2" x 11" Arched Escutcheon</b>  <b>Profile Cylinder</b>                      E754 / E754 Entry Trim* ..... \$ 1,007                      E751 / E754 Patio Trim* ..... \$ 929                      E751 / E751 Full Dummy ..... \$ 697</p> <ul style="list-style-type: none"> <li>• Entry Trim includes Profile cylinder and turn piece.</li> <li>• Patio Trim includes 1/2 Profile cylinder and turn piece.</li> </ul> <p>* The center to center dimension will need to be verified before set can be ordered.</p>
<p><b>B</b></p>  <p>E754 E754</p>  <p>E751 E754</p>	 <p>E751 E751</p>	

- Price includes your choice of lever. (Knobs and rings are not recommended for multi-point combinations.) Call RMH for pricing.
- Combinations are shown with L105 Beaver Tail Lever for illustrations purposes only. Refer to Section A for desired lever.
- Entry, Patio, and Passage functions include 8mm spindle.
- Specify metal, patina, handing, backset, door thickness, lock type, and center-to-center dimension.
- Refer to Section B for Escutcheon Specifications.

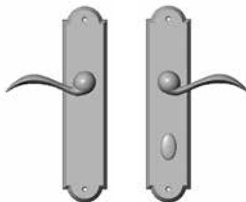
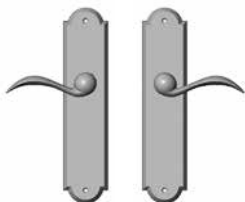
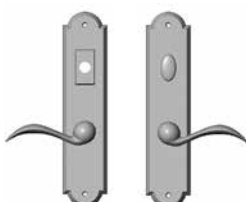
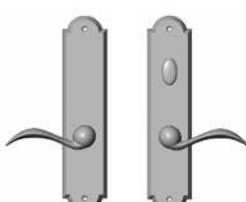
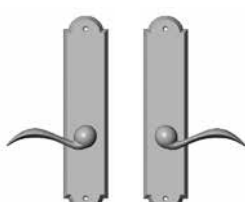
	ACTIVE	DUMMY	ESCUTCHEON OPTIONS
<b>A</b>	 <p>E750 E753</p>		<p><b>A 2 1/2" x 11" Arched Escutcheon</b>  <b>American Cylinder</b>                      E750 / E753 Entry Trim* ..... \$ 872                      E751 / E753 Patio Trim* ..... \$ 816                      E751 / E751 Passage Trim ..... \$ 762                      E751 / E751 Full Dummy ..... \$ 697</p> <ul style="list-style-type: none"> <li>• Entry Trim includes American cylinder and turn piece.</li> <li>• Patio Trim includes turn piece.</li> </ul>
	 <p>E751 E753</p>	 <p>E751 E751</p>	
<b>B</b>	 <p>E757 E756</p>		<p><b>B 2 1/2" x 11" Arched Escutcheon</b>  <b>American Cylinder</b>                      E757 / E756 Entry Trim* ..... \$ 872                      E755 / E756 Patio Trim* ..... \$ 816                      E755 / E755 Passage Trim ..... \$ 762                      E755 / E755 Full Dummy ..... \$ 697</p> <ul style="list-style-type: none"> <li>• Entry Trim includes American cylinder and turn piece.</li> <li>• Patio Trim includes turn piece.</li> </ul> <p>* The center to center dimension will need to be verified before set can be ordered.</p>
	 <p>E755 E756</p>	 <p>E755 E755</p>	

- Price includes your choice of lever. (Knobs and rings are not recommended for multi-point combinations.) Call RMH for pricing.
- Combinations are shown with L30180 Chateau Lever for illustrations purposes only. Refer to Section A for desired lever.
- Entry, Patio, and Passage functions include 8mm spindle.
- Specify metal, patina, handing, backset, door thickness, lock type, and center-to-center dimension.
- Refer to Section B for Escutcheon Specifications.

ACTIVE

DUMMY

A

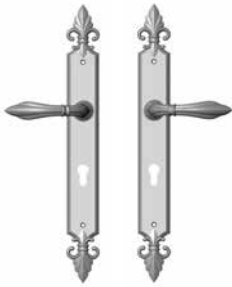

E30868 E30868



E30865 E30868

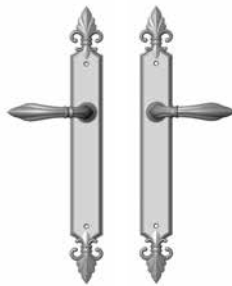

E30865 E30865

A 2" x 17" Bordeaux Escutcheon

Profile Cylinder

E30868 / E30868 Entry Trim\* ..... \$1,355

E30865 / E30868 Patio Trim\* ..... \$1,256

E30865 / E30865 Full Dummy ..... \$995

- Entry Trim includes Profile cylinder and turn piece.
- Patio Trim includes 1/2 Profile cylinder turn piece.

\* The center to center dimension will need to be verified before set can be ordered.

- Price includes your choice of lever. (Knobs and rings are not recommended for multi-point combinations.) Call RMH for pricing.
- Combinations are shown with L30180 Chateau Lever for illustrations purposes only. Refer to Section A for desired lever.
- Entry, Patio, and Passage functions include 8mm spindle.
- Specify metal, patina, handing, backset, door thickness, lock type, and center-to-center dimension.
- Refer to Section B for Escutcheon Specifications.

ACTIVE

DUMMY

ESCUTCHEON OPTIONS

A

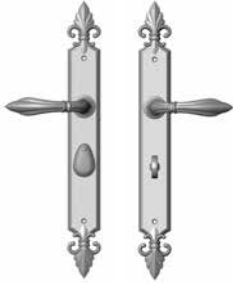

E30867 E30866

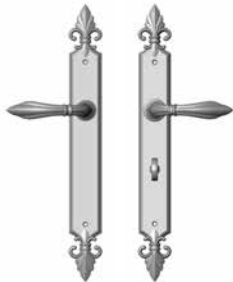

E30865 E30866

B

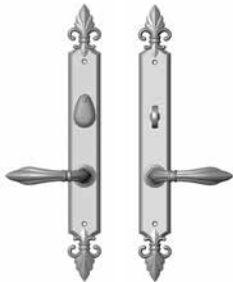

E30863 E30862

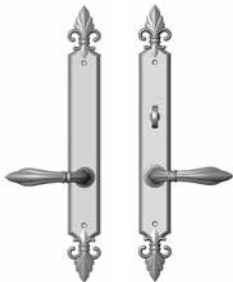

E30861 E30862

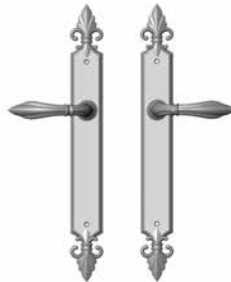

E30865 E30865

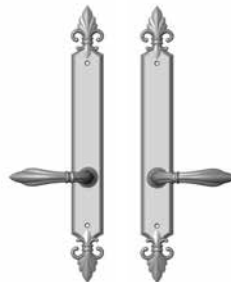

E30861 E30861

**A 2" x 17" Bordeaux Escutcheon  
American Cylinder**

E30867 / E30866 Entry Trim*	\$ 1,208
E30865 / E30866 Patio Trim*	\$ 1,126
E30865 / E30865 Passage Trim	\$ 1,061
E30865 / E30865 Full Dummy	\$ 995

- Entry Trim includes American cylinder and turn piece.
- Patio Trim includes turn piece.

**B 2" x 17" Bordeaux Escutcheon  
American Cylinder**

E30863 / E30862 Entry Trim*	\$ 1,208
E30861 / E30862 Patio Trim*	\$ 1,126
E30861 / E30861 Passage Trim	\$ 1,061
E30861 / E30861 Full Dummy	\$ 995

- Entry Trim includes American cylinder and turn piece.
- Patio Trim includes turn piece.

\* The center to center dimension will need to be verified before set can be ordered.



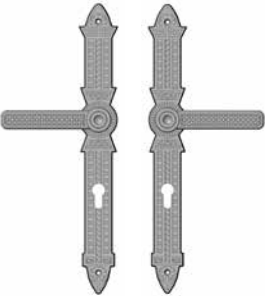
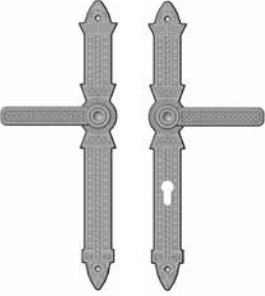
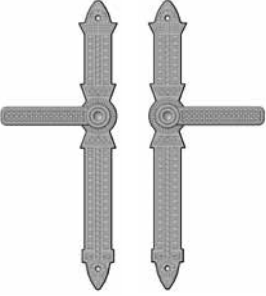
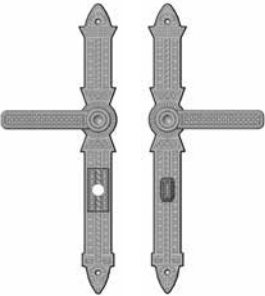
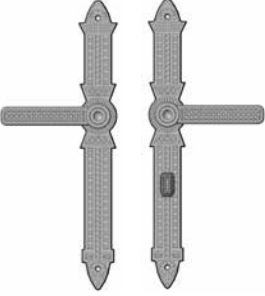
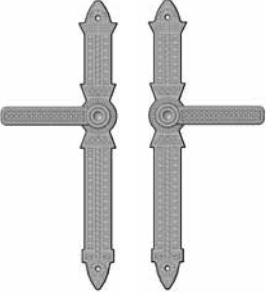

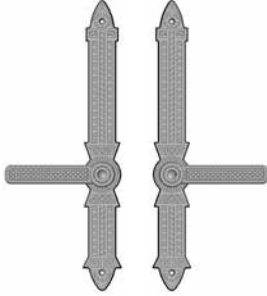
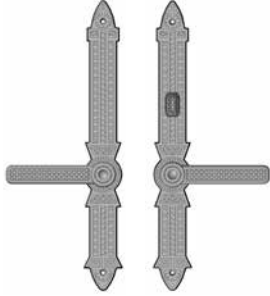

- Price includes your choice of lever. (Knobs and rings are not recommended for multi-point combinations.) Call RMH for pricing.
- Combinations are shown with L10801 Briggs Lever for illustrations purposes only. Refer to Section A for desired lever.
- Entry, Patio, and Passage functions include 8mm spindle.
- Specify metal, patina, handing, backset, door thickness, lock type, and center-to-center dimension.
- Refer to Section B for Escutcheon Specifications.

	ACTIVE	DUMMY	ESCUTCHEON OPTIONS
<b>A</b>	 E10873		<b>A 2" x 15" Briggs Escutcheon Profile Cylinder</b> E10873 / E10873 Entry Trim* ..... \$ 1,007 E10871 / E10873 Patio Trim* ..... \$ 929 E10871 / E10871 Full Dummy ..... \$ 697 • Entry Trim includes Profile cylinder and turn piece. • Patio Trim includes 1/2 Profile cylinder turn piece. Refer to spec page B24 • Escutcheon width varies. Narrowest width is 1 13/32".
	 E10871 E10873	 E10871 E10871	
<b>B</b>	 E10870 E10872		<b>B 2" x 15" Briggs Escutcheon American Cylinder</b> E10870 / E10872 Entry Trim* ..... \$ 895 E10871 / E10872 Patio Trim* ..... \$ 839 E10871 / E10871 Passage Trim ..... \$ 762 E10871 / E10871 Full Dummy ..... \$ 697 • Entry Trim includes American cylinder and turn piece. • Patio Trim includes turn piece. Refer to spec page B24 • Escutcheon width varies. Narrowest width is 1 13/32". * The center to center dimension will need to be verified before set can be ordered.
	 E10871 E10872	 E10871 E10871	

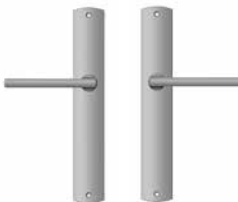

- Price includes your choice of lever. (Knobs and rings are not recommended for multi-point combinations.) Call RMH for pricing.
- Combinations are shown with L10801 Briggs Lever for illustrations purposes only. Refer to Section A for desired lever.
- Entry, Patio, and Passage functions include 8mm spindle.
- Specify metal, patina, handing, backset, door thickness, lock type, and center-to-center dimension.
- Refer to Section B for Escutcheon Specifications.

	ACTIVE	DUMMY	ESCUTCHEON OPTIONS
A	 <p>E10875 E10876</p>	 <p>E10874 E10874</p>	<p><b>A 2" x 15" Briggs Escutcheon</b></p> <p><b>American Cylinder</b></p> <p>E10875 / E10876 Entry Trim* ..... \$ 895</p> <p>E10874 / E10876 Patio Trim* ..... \$ 839</p> <p>E10874 / E10874 Passage Trim ..... \$ 762</p> <p>E10874 / E10874 Full Dummy ..... \$ 697</p> <ul style="list-style-type: none"> <li>• Entry Trim includes American cylinder and turn piece.</li> <li>• Patio Trim includes turn piece.</li> <li>• Escutcheon width varies. Narrowest width is 1 13/32".</li> </ul> <p>* The center to center dimension will need to be verified before set can be ordered.</p>
	 <p>E10874 E10876</p>		

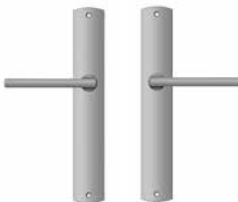

- Price includes your choice of lever. (Knobs and rings are not recommended for multi-point combinations.) Call RMH for pricing.
- Combinations are shown with L135 Olympus Lever for illustrations purposes only. Refer to Section A for desired lever.
- Entry, Patio, and Passage functions include 8mm spindle.
- Specify metal, patina, handing, backset, door thickness, lock type, and center-to-center dimension.
- Refer to Section B for Escutcheon Specifications.

ACTIVE	DUMMY	ESCUTCHEON OPTIONS
<p><b>A</b></p>  <p>E30568 E30568</p>	<p><b>DUMMY</b></p>  <p>E30565 E30565</p>	<p><b>A 13/4" x 11" Convex Escutcheon</b>  <b>Profile Cylinder</b>                      E30568 / E30568 Entry Trim* ..... \$ 1,355                      E30565 / E30568 Patio Trim* ..... \$ 1,256                      E30565 / E30565 Full Dummy ..... \$ 995</p> <ul style="list-style-type: none"> <li>• Entry Trim includes Profile cylinder and turn piece.</li> <li>• Patio Trim includes 1/2 Profile cylinder and turn piece.</li> </ul>
 <p>E30565 E30568</p>	 <p>E30565 E30565</p>	<p><b>B 13/4" x 11" Convex Escutcheon</b>  <b>American Cylinder</b>                      E30567 / E30566 Entry Trim* ..... \$ 1,208                      E30565 / E30566 Patio Trim* ..... \$ 1,126                      E30565 / E30565 Passage Trim ..... \$ 1,061                      E30565 / E30565 Full Dummy ..... \$ 995</p> <ul style="list-style-type: none"> <li>• Entry Trim includes American cylinder and turn piece.</li> <li>• Patio Trim includes turn piece.</li> </ul>
<p><b>B</b></p>  <p>E30567 E30566</p>	 <p>E30565 E30565</p>	<p>* The center to center dimension will need to be verified before set can be ordered.</p>
 <p>E30565 E30566</p>	 <p>E30565 E30565</p>	

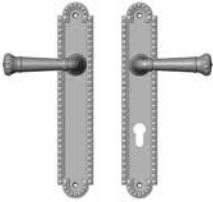
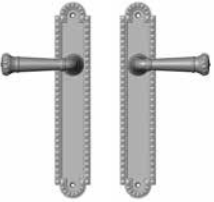

- Price includes your choice of lever. (Knobs and rings are not recommended for multi-point combinations.) Call RMH for pricing.
- Combinations are shown with L135 Olympus Lever for illustrations purposes only. Refer to Section A for desired lever.
- Entry, Patio, and Passage functions include 8mm spindle.
- Specify metal, patina, handing, backset, door thickness, lock type, and center-to-center dimension.
- Refer to Section B for Escutcheon Specifications.

ACTIVE	DUMMY	ESCUTCHEON OPTIONS
<p><b>A</b></p>  <p>E30563 E30562</p>	 <p>E30561 E30561</p>	<p><b>A 13/4" x 11" Convex Escutcheon</b>  <b>American Cylinder</b>                      E30563 / E30562 Entry Trim* ..... \$ 1,208                      E30561 / E30562 Patio Trim* ..... \$ 1,126                      E30561 / E30561 Passage Trim ..... \$ 1,061                      E30561 / E30561 Full Dummy..... \$ 995</p> <ul style="list-style-type: none"> <li>• Entry Trim includes American cylinder and turn piece.</li> <li>• Patio Trim includes turn piece.</li> </ul> <p>* The center to center dimension will need to be verified before set can be ordered.</p>
 <p>E30561 E30562</p>		

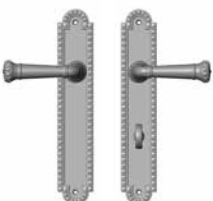
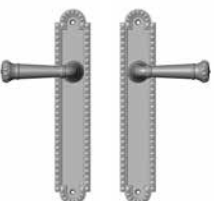

- Price includes your choice of lever. (Knobs and rings are not recommended for multi-point combinations.) Call RMH for pricing.
- Combinations are shown with L30160 Crown Lever for illustrations purposes only. Refer to Section A for desired lever.
- Entry, Patio, and Passage functions include 8mm spindle.
- Specify metal, patina, handing, backset, door thickness, lock type, and center-to-center dimension.
- Refer to Section B for Escutcheon Specifications.

	ACTIVE	DUMMY	ESCUTCHEON OPTIONS
<b>A</b>	 <p>E30668 E30668</p>		<p><b>A 2" x 11" Corbel Arched Escutcheon Profile Cylinder</b></p> <p>E30668 / E30668 Entry Trim* ..... \$ 1,355</p> <p>E30665 / E30668 Patio Trim* ..... \$ 1,256</p> <p>E30665 / E30665 Full Dummy ..... \$ 995</p> <ul style="list-style-type: none"> <li>• Entry Trim includes Profile cylinder and turn piece.</li> <li>• Patio Trim includes 1/2 Profile cylinder and turn piece.</li> </ul>
	 <p>E30665 E30668</p>	 <p>E30665 E30665</p>	
<b>B</b>	 <p>E30667 E30666</p>		<p>* The center to center dimension will need to be verified before set can be ordered.</p>
	 <p>E30665 E30666</p>	 <p>E30665 E30665</p>	

- Price includes your choice of lever. (Knobs and rings are not recommended for multi-point combinations.) Call RMH for pricing.
- Combinations are shown with L30160 Crown Lever for illustrations purposes only. Refer to Section A for desired lever.
- Entry, Patio, and Passage functions include 8mm spindle.
- Specify metal, patina, handing, backset, door thickness, lock type, and center-to-center dimension.
- Refer to Section B for Escutcheon Specifications.

	ACTIVE	DUMMY	ESCUTCHEON OPTIONS
<b>A</b>	 <p>E30663 E30662</p>		<p><b>A 2" x 11" Corbel Arched Escutcheon</b>  <b>American Cylinder</b>                      E30663 / E30662 Entry Trim* ..... \$ 1,208                      E30661 / E30662 Patio Trim* ..... \$ 1,126                      E30661 / E30661 Passage Trim ..... \$ 1,061                      E30661 / E30661 Full Dummy ..... \$ 995</p> <ul style="list-style-type: none"> <li>• Entry Trim includes American cylinder and turn piece.</li> <li>• Patio Trim includes turn piece.</li> </ul>
	 <p>E30661 E30662</p>	 <p>E30661 E30661</p>	

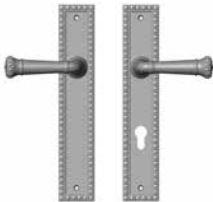
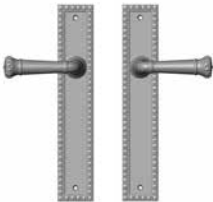
- Price includes your choice of lever. (Knobs and rings are not recommended for multi-point combinations.) Call RMH for pricing.
- Combinations are shown with L30160 Crown Lever for illustrations purposes only. Refer to Section A for desired lever.
- Entry, Patio, and Passage functions include 8mm spindle.
- Specify metal, patina, handing, backset, door thickness, lock type, and center-to-center dimension.
- Refer to Section B for Escutcheon Specifications.

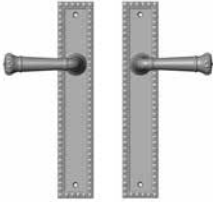
	ACTIVE	DUMMY	ESCUTCHEON OPTIONS
A	 <p>E30768 E30768</p>		<p><b>A 2" x 11" Corbel Rectangular Escutcheon Profile Cylinder</b></p> <p>E30768 / E30768 Entry Trim* ..... \$ 1,355</p> <p>E30765 / E30768 Patio Trim* ..... \$ 1,256</p> <p>E30765 / E30765 Full Dummy ..... \$ 995</p> <ul style="list-style-type: none"> <li>• Entry Trim includes Profile cylinder and turn piece.</li> <li>• Patio Trim includes 1/2 Profile cylinder and turn piece.</li> </ul>
	 <p>E30765 E30768</p>	 <p>E30765 E30765</p>	
B	 <p>E30767 E30766</p>		<p>* The center to center dimension will need to be verified before set can be ordered.</p>
	 <p>E30765 E30766</p>	 <p>E30765 E30765</p>	

- Price includes your choice of lever. (Knobs and rings are not recommended for multi-point combinations.) Call RMH for pricing.
- Combinations are shown with L30160 Crown Lever for illustrations purposes only. Refer to Section A for desired lever.
- Entry, Patio, and Passage functions include 8mm spindle.
- Specify metal, patina, handing, backset, door thickness, lock type, and center-to-center dimension.
- Refer to Section B for Escutcheon Specifications.

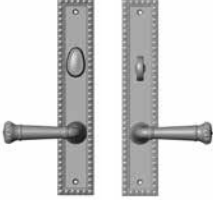
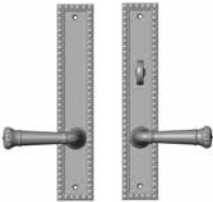
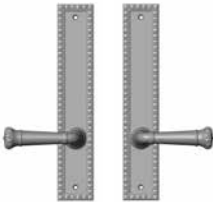
ACTIVE	DUMMY	ESCUTCHEON OPTIONS
<p><b>A</b></p>  <p>E30763 E30762</p>  <p>E30761 E30762</p>	 <p>E30761 E30761</p>	<p><b>A 2" x 11" Corbel Rectangular Escutcheon</b>  <b>American Cylinder</b>                      E30763 / E30762 Entry Trim*..... \$ 1,208                      E30761 / E30762 Patio Trim*..... \$ 1,126                      E30761 / E30761 Passage Trim..... \$ 1,061                      E30761 / E30761 Full Dummy..... \$ 995</p> <ul style="list-style-type: none"> <li>• Entry Trim includes American cylinder and turn piece.</li> <li>• Patio Trim includes turn piece.</li> </ul>

- Price includes your choice of lever. (Knobs and rings are not recommended for multi-point combinations.) Call RMH for pricing.
- Combinations are shown with L135 Olympus Lever for illustrations purposes only. Refer to Section A for desired lever.
- Entry, Patio, and Passage functions include 8mm spindle.
- Specify metal, patina, handing, backset, door thickness, lock type, and center-to-center dimension.
- Refer to Section B for Escutcheon Specifications.

ACTIVE

DUMMY

ESCUTCHEON OPTIONS

A



E575 E575



E576 E575

B



E578 E577



E576 E577

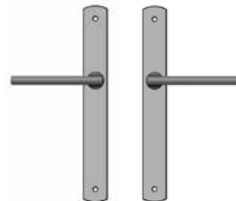

E576 E576

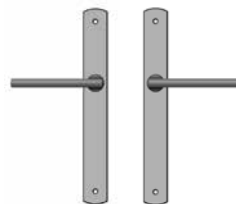

E576 E576

**A 1 3/8" x 11" Curved Escutcheon**

**Profile Cylinder**

E575 / E575 Entry Trim*	\$ 976
E576 / E575 Patio Trim*	\$ 899
E576 / E576 Full Dummy	\$ 665

- Entry Trim includes Profile cylinder and turn piece.
- Patio Trim includes 1/2 Profile cylinder and turn piece.

**B 1 3/8" x 11" Curved Escutcheon**

**American Cylinder**

E578 / E577 Entry Trim*	\$ 907
E576 / E577 Patio Trim*	\$ 781
E576 / E576 Passage Trim	\$ 714
E576 / E576 Full Dummy	\$ 665

- Entry Trim includes Profile cylinder and turn piece.
- Patio Trim includes turn piece.

- Price includes your choice of lever. (Knobs and rings are not recommended for multi-point combinations.) Call RMH for pricing.
- Combinations are shown with L135 Olympus Lever for illustrations purposes only. Refer to Section A for desired lever.
- Entry, Patio, and Passage functions include 8mm spindle.
- Specify metal, patina, handing, backset, door thickness, lock type, and center-to-center dimension.
- Refer to Section B for Escutcheon Specifications.

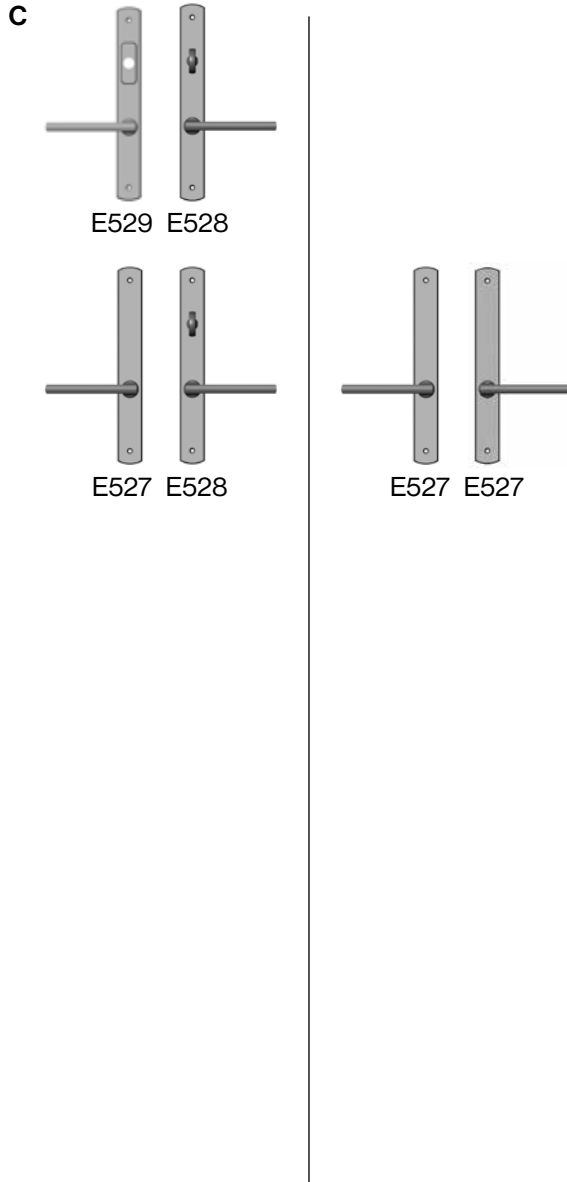



**C 1 3/8" x 11" Curved Escutcheon  
American Cylinder**

E529 / E528 Entry Trim*	\$ 907
E527 / E528 Patio Trim*	\$ 781
E527 / E527 Passage Trim	\$ 714
E527 / E527 Full Dummy	\$ 665

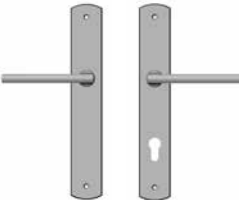
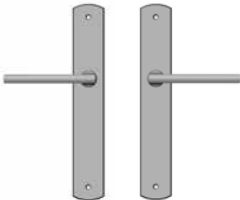

- Entry Trim includes Profile cylinder and turn piece.
- Patio Trim includes turn piece.

\* The center to center dimension will need to be verified before set can be ordered.

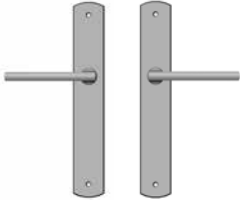



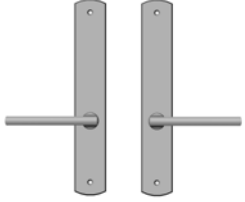

- Price includes your choice of lever. (Knobs and rings are not recommended for multi-point combinations.) Call RMH for pricing.
- Combinations are shown with L135 Olympus Lever for illustrations purposes only. Refer to Section A for desired lever.
- Entry, Patio, and Passage functions include 8mm spindle.
- Specify metal, patina, handing, backset, door thickness, lock type, and center-to-center dimension.
- Refer to Section B for Escutcheon Specifications.

ACTIVE	DUMMY	ESCUTCHEON OPTIONS
<p><b>A</b></p>  <p>E532 E532</p>		<p><b>A 13/4" x 11" Curved Escutcheon</b>  <b>Profile Cylinder</b>                      E532 / E532 Entry Trim* ..... \$ 1,007                      E530 / E532 Patio Trim* ..... \$ 929                      E530 / E530 Full Dummy ..... \$ 697</p> <ul style="list-style-type: none"> <li>• Entry Trim includes Profile cylinder and turn piece.</li> <li>• Patio Trim includes 1/2 Profile cylinder and turn piece.</li> </ul>
 <p>E530 E532</p>	 <p>E530 E530</p>	<p><b>B 13/4" x 11" Curved Escutcheon</b>  <b>American Cylinder</b>                      E538 / E536 Entry Trim* ..... \$ 872                      E530 / E536 Patio Trim* ..... \$ 816                      E530 / E530 Passage Trim ..... \$ 762                      E530 / E530 Full Dummy ..... \$ 697</p> <ul style="list-style-type: none"> <li>• Entry Trim includes American cylinder and turn piece.</li> <li>• Patio Trim includes turn piece.</li> </ul>
<p><b>B</b></p>  <p>E538 E536</p>		<p>* The center to center dimension will need to be verified before set can be ordered.</p>
 <p>E530 E536</p>	 <p>E530 E530</p>	



- Price includes your choice of lever. (Knobs and rings are not recommended for multi-point combinations.) Call RMH for pricing.
- Combinations are shown with L135 Olympus Lever for illustrations purposes only. Refer to Section A for desired lever.
- Entry, Patio, and Passage functions include 8mm spindle.
- Specify metal, patina, handing, backset, door thickness, lock type, and center-to-center dimension.
- Refer to Section B for Escutcheon Specifications.

	ACTIVE	DUMMY	ESCUTCHEON OPTIONS								
A	 <p>E539 E537</p>	 <p>E531 E531</p>	<p><b>A 13/4" x 11" Curved Escutcheon</b>  <b>American Cylinder</b></p> <table border="0"> <tr> <td>E539 / E537 Entry Trim*</td> <td>\$ 872</td> </tr> <tr> <td>E531 / E537 Patio Trim*</td> <td>\$ 816</td> </tr> <tr> <td>E531 / E531 Passage Trim</td> <td>\$ 762</td> </tr> <tr> <td>E531 / E531 Full Dummy</td> <td>\$ 697</td> </tr> </table> <ul style="list-style-type: none"> <li>• Entry Trim includes American cylinder and turn piece.</li> <li>• Patio Trim includes turn piece.</li> </ul> <p>* The center to center dimension will need to be verified before set can be ordered.</p>	E539 / E537 Entry Trim*	\$ 872	E531 / E537 Patio Trim*	\$ 816	E531 / E531 Passage Trim	\$ 762	E531 / E531 Full Dummy	\$ 697
	E539 / E537 Entry Trim*			\$ 872							
E531 / E537 Patio Trim*	\$ 816										
E531 / E531 Passage Trim	\$ 762										
E531 / E531 Full Dummy	\$ 697										
	 <p>E531 E537</p>										





- Price includes your choice of lever. (Knobs and rings are not recommended for multi-point combinations.) Call RMH for pricing.
- Combinations are shown with L304 Reed Lever for illustrations purposes only. Refer to Section A for desired lever.
- Entry, Patio, and Passage functions include 8mm spindle.
- Specify metal, style, patina, handing, backset, door thickness, lock type, and center-to-center dimension.
- Requires a minimum of 1 3/4" door thickness.
- Refer to Section B for Escutcheon Specifications.

ACTIVE	DUMMY	ESCUTCHEON OPTIONS
<p><b>A</b></p>  <p>E198 E198</p>		<p><b>A 1 3/4" x 11" Edge Escutcheon</b>  <b>Profile Cylinder</b>                      E198 / E198 Entry Trim* ..... \$ 1,007                      E195 / E198 Patio Trim*..... \$ 929                      E195 / E195 Full Dummy..... \$ 697</p> <ul style="list-style-type: none"> <li>• Entry Trim includes Profile cylinder and turn piece.</li> <li>• Patio Trim includes 1/2 Profile cylinder and turn piece.</li> </ul>
 <p>E195 E198</p>	 <p>E195 E195</p>	<p><b>B 1 3/4" x 11" Edge Escutcheon</b>  <b>American Cylinder</b>                      E197 / E196 Entry Trim* ..... \$ 872                      E195 / E196 Patio Trim*..... \$ 816                      E195 / E195 Passage Trim ..... \$ 762                      E195 / E195 Full Dummy..... \$ 697</p> <ul style="list-style-type: none"> <li>• Entry Trim includes American cylinder and turn piece.</li> <li>• Patio Trim includes turn piece.</li> </ul>
<p><b>B</b></p>  <p>E197 E196</p>		<p>* The center to center dimension will need to be verified before set can be ordered.</p>
 <p>E195 E196</p>	 <p>E195 E195</p>	

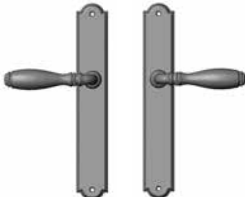

- Price includes your choice of lever. (Knobs and rings are not recommended for multi-point combinations.) Call RMH for pricing.
- Combinations are shown with L304 Reed Lever for illustrations purposes only. Refer to Section A for desired lever.
- Entry, Patio, and Passage functions include 8mm spindle.
- Specify metal, style, patina, handing, backset, door thickness, lock type, and center-to-center dimension.
- Requires a minimum of 1 3/4" door thickness.
- Refer to Section B for Escutcheon Specifications.

ACTIVE	DUMMY	ESCUTCHEON OPTIONS								
<p><b>A</b></p>  <p>E193 E192</p>	 <p>E191 E191</p>	<p><b>A 1 3/4" x 11" Edge Escutcheon</b>  <b>American Cylinder</b></p> <table border="0"> <tr> <td>E193 / E192 Entry Trim*</td> <td>\$ 872</td> </tr> <tr> <td>E191 / E192 Patio Trim*</td> <td>\$ 816</td> </tr> <tr> <td>E191 / E191 Passage Trim</td> <td>\$ 762</td> </tr> <tr> <td>E191 / E191 Full Dummy</td> <td>\$ 697</td> </tr> </table> <ul style="list-style-type: none"> <li>• Entry Trim includes American cylinder and turn piece.</li> <li>• Patio Trim includes turn piece.</li> </ul> <p>* The center to center dimension will need to be verified before set can be ordered.</p>	E193 / E192 Entry Trim*	\$ 872	E191 / E192 Patio Trim*	\$ 816	E191 / E191 Passage Trim	\$ 762	E191 / E191 Full Dummy	\$ 697
E193 / E192 Entry Trim*	\$ 872									
E191 / E192 Patio Trim*	\$ 816									
E191 / E191 Passage Trim	\$ 762									
E191 / E191 Full Dummy	\$ 697									
 <p>E191 E192</p>										

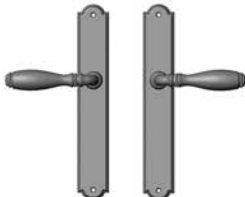

- Price includes your choice of lever. (Knobs and rings are not recommended for multi-point combinations.) Call RMH for pricing.
- Combinations are shown with L075 Ellis Lever for illustrations purposes only. Refer to Section A for desired lever.
- Entry, Patio, and Passage functions include 8mm spindle.
- Specify metal, patina, handing, backset, door thickness, lock type, and center-to-center dimension.
- Refer to Section B for Escutcheon Specifications.

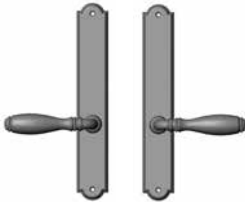
	ACTIVE	DUMMY	ESCUTCHEON OPTIONS
<b>A</b>	 <p>E046 E046</p>		<p><b>A 13/4" x 11" Ellis Escutcheon Profile Cylinder</b></p> <p>E046 / E046 Entry Trim* ..... \$ 1,355</p> <p>E041 / E046 Patio Trim* ..... \$ 1,256</p> <p>E041 / E041 Full Dummy ..... \$ 995</p> <ul style="list-style-type: none"> <li>• Entry Trim includes Profile cylinder and turn piece.</li> <li>• Patio Trim includes 1/2 Profile cylinder and turn piece.</li> </ul>
	 <p>E041 E046</p>	 <p>E041 E041</p>	
<b>B</b>	 <p>E045 E043</p>		<p><b>B 13/4" x 11" Ellis Escutcheon American Cylinder</b></p> <p>E045 / E043 Entry Trim* ..... \$ 1,208</p> <p>E041 / E043 Patio Trim* ..... \$ 1,126</p> <p>E041 / E041 Passage Trim ..... \$ 1,061</p> <p>E041 / E041 Full Dummy ..... \$ 995</p> <ul style="list-style-type: none"> <li>• Entry Trim includes American cylinder and turn piece.</li> <li>• Patio Trim includes turn piece.</li> </ul> <p>* The center to center dimension will need to be verified before set can be ordered.</p>
	 <p>E041 E043</p>	 <p>E041 E041</p>	

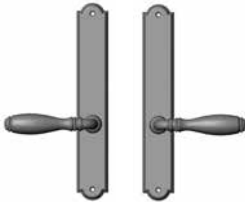

- Price includes your choice of lever. (Knobs and rings are not recommended for multi-point combinations.) Call RMH for pricing.
- Combinations are shown with L075 Ellis Lever for illustrations purposes only. Refer to Section A for desired lever.
- Entry, Patio, and Passage functions include 8mm spindle.
- Specify metal, patina, handing, backset, door thickness, lock type, and center-to-center dimension.
- Refer to Section B for Escutcheon Specifications.

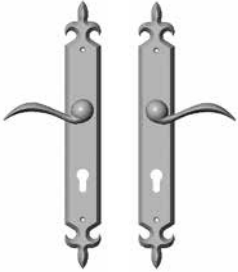
	ACTIVE	DUMMY	ESCUTCHEON OPTIONS
<b>A</b>	 <p>E044 E042</p>	 <p>E040 E042</p>	<p><b>A 13/4" x 11" Ellis Escutcheon</b>  <b>American Cylinder</b>                      E044 / E042 Entry Trim* ..... \$ 1,208                      E040 / E042 Patio Trim* ..... \$ 1,126                      E040 / E040 Passage Trim ..... \$ 1,061                      E040 / E040 Full Dummy ..... \$ 995</p> <ul style="list-style-type: none"> <li>• Entry Trim includes American cylinder and turn piece.</li> <li>• Patio Trim includes turn piece.</li> </ul> <p>* The center to center dimension will need to be verified before set can be ordered.</p>
	 <p>E040 E042</p>	 <p>E040 E040</p>	

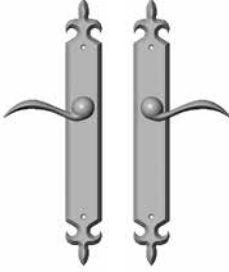
- Price includes your choice of lever. (Knobs and rings are not recommended for multi-point combinations.) Call RMH for pricing.
- Combinations are shown with L105 Beaver Tail Lever for illustrations purposes only. Refer to Section A for desired lever.
- Entry, Patio, and Passage functions include 8mm spindle.
- Specify metal, patina, handing, backset, door thickness, lock type, and center-to-center dimension.
- Refer to Section B for Escutcheon Specifications.

ACTIVE	DUMMY	ESCUTCHEON OPTIONS
<p><b>A</b></p>  <p>E825 E825</p>  <p>E824 E825</p>	 <p>E824 E824</p>	<p><b>A 2" x 15" Fleur De Lis Escutcheon</b></p> <p><b>Profile Cylinder</b></p> <p>E825 / E825 Entry Trim* ..... \$ 1,007</p> <p>E824 / E825 Patio Trim* ..... \$ 929</p> <p>E824 / E824 Full Dummy ..... \$ 697</p> <ul style="list-style-type: none"> <li>• Entry Trim includes Profile cylinder and turn piece.</li> <li>• Patio Trim includes 1/2 Profile cylinder and turn piece.</li> </ul> <p>* The center to center dimension will need to be verified before set can be ordered.</p>

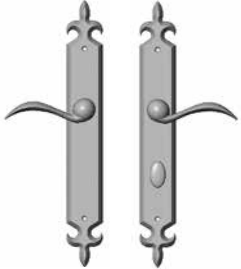
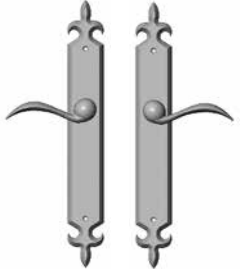

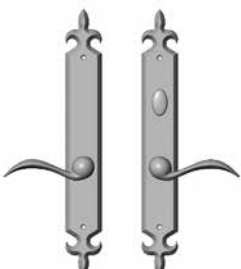
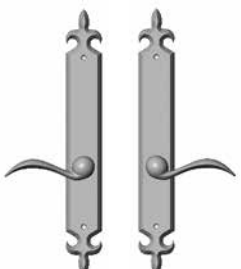
- Price includes your choice of lever. (Knobs and rings are not recommended for multi-point combinations.) Call RMH for pricing.
- Combinations are shown with L105 Beaver Tail Lever for illustrations purposes only. Refer to Section A for desired lever.
- Entry, Patio, and Passage functions include 8mm spindle.
- Specify metal, patina, handing, backset, door thickness, lock type, and center-to-center dimension.
- Refer to Section B for Escutcheon Specifications.

	ACTIVE	DUMMY	ESCUTCHEON OPTIONS
<b>A</b>			<b>A 2" x 15" Fleur De Lis Escutcheon American Cylinder</b> E826 / E827 Entry Trim* ..... \$ 872 E824 / E827 Patio Trim* ..... \$ 816 E824 / E824 Passage Trim ..... \$ 762 E824 / E824 Full Dummy ..... \$ 697 • Entry Trim includes American cylinder and turn piece. • Patio Trim includes turn piece.  * The center to center dimension will need to be verified before set can be ordered.
			
			
<b>B</b>			<b>B 2" x 15" Fleur De Lis Escutcheon American Cylinder</b> E819 / E818 Entry Trim* ..... \$ 872 E817 / E818 Patio Trim* ..... \$ 816 E817 / E817 Passage Trim ..... \$ 762 E817 / E817 Full Dummy ..... \$ 697 • Entry Trim includes American cylinder and turn piece. • Patio Trim includes turn piece.  * The center to center dimension will need to be verified before set can be ordered.
			
			

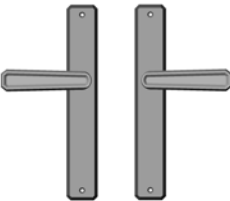
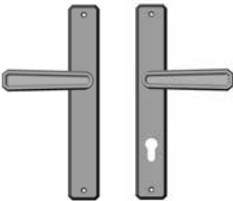
- Price includes your choice of lever. (Knobs and rings are not recommended for multi-point combinations.) Call RMH for pricing.
- Combinations are shown with L30140 Smith Lever for illustrations purposes only. Refer to Section A for desired lever.
- Entry and Patio functions include 8mm spindle.
- Specify metal, patina, handing, backset, door thickness, lock type, and center-to-center dimension.
- Refer to Section B for Escutcheon Specifications.

ACTIVE	DUMMY	ESCUTCHEON OPTIONS
<p><b>A</b></p>  <p>E30468 E30468</p>	 <p>E30465 E30465</p>	<p><b>A 13/4" x 11" Hammered Escutcheon</b>  <b>Profile Cylinder</b>                      E30468 / E30468 Entry Trim* ..... \$ 1,007                      E30465 / E30468 Patio Trim* ..... \$ 929                      E30465 / E30465 Full Dummy ..... \$ 697</p> <ul style="list-style-type: none"> <li>• Entry Trim includes Profile cylinder and turn piece.</li> <li>• Patio Trim includes 1/2 Profile cylinder and turn piece.</li> </ul> <p>* The center to center dimension will need to be verified before set can be ordered.</p>
 <p>E30465 E30468</p>		

- Price includes your choice of lever. (Knobs and rings are not recommended for multi-point combinations.) Call RMH for pricing.
- Combinations are shown with L30140 Smith Lever for illustrations purposes only. Refer to Section A for desired lever.
- Entry, Patio, and Passage functions include 8mm spindle.
- Specify metal, patina, handing, backset, door thickness, lock type, and center-to-center dimension.
- Refer to Section B for Escutcheon Specifications.

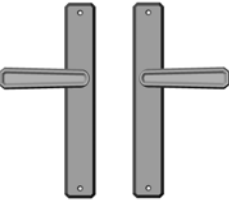
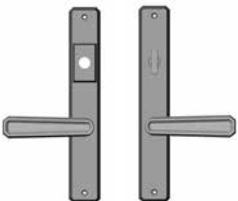
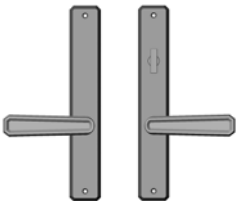
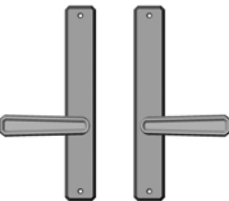
	ACTIVE	DUMMY	ESCUTCHEON OPTIONS
<b>A</b>	 <p>E30467 E30466</p>		<p><b>A 13/4" x 11" Hammered Escutcheon American Cylinder</b></p> <p>E30467 / E30466 Entry Trim* ..... \$ 872                      E30465 / E30466 Patio Trim* ..... \$ 816                      E30465 / E30465 Passage Trim ..... \$ 762                      E30465 / E30465 Full Dummy ..... \$ 697</p> <ul style="list-style-type: none"> <li>• Entry Trim includes American cylinder and turn piece.</li> <li>• Patio Trim includes turn piece.</li> </ul>
	 <p>E30465 E30466</p>	 <p>E30465 E30465</p>	
<b>B</b>	 <p>E30463 E30462</p>		
	 <p>E30461 E30462</p>	 <p>E30461 E30461</p>	
			<p><b>B 13/4" x 11" Hammered Escutcheon American Cylinder</b></p> <p>E30463 / E30462 Entry Trim* ..... \$ 872                      E30461 / E30462 Patio Trim* ..... \$ 816                      E30461 / E30461 Passage Trim ..... \$ 762                      E30461 / E30461 Full Dummy..... \$ 697</p> <ul style="list-style-type: none"> <li>• Entry Trim includes American cylinder and turn piece.</li> <li>• Patio Trim includes turn piece.</li> <li>• Entry, Patio, and Passage trim includes an 8mm spindle.</li> </ul> <p>* The center to center dimension will need to be verified before set can be ordered.</p>



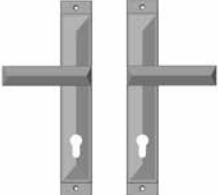
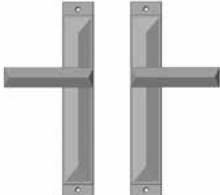
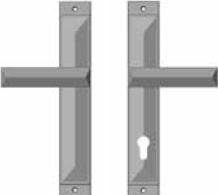

- Price includes your choice of lever. (Knobs and rings are not recommended for multi-point combinations.) Call RMH for pricing.
- Combinations are shown with L21005 Emile Lever for illustrations purposes only. Refer to Section A for desired lever.
- Entry, Patio, and Passage functions include 8mm spindle.
- Specify metal, patina, handing, backset, door thickness, lock type, and center-to-center dimension.
- Refer to Section B for Escutcheon Specifications.

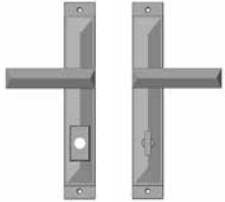
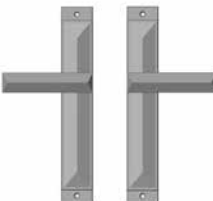
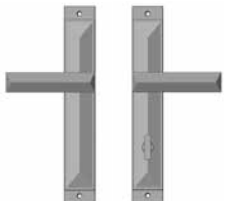
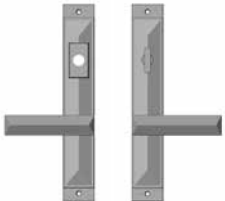
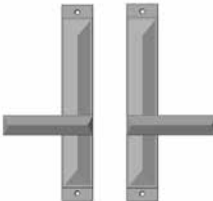
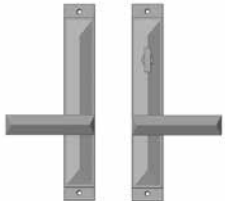
ACTIVE	DUMMY	ESCUTCHEON OPTIONS
<p><b>A</b></p>  <p>E21046 E21046</p>	 <p>E21041 E21041</p>	<p><b>A 1 3/4" x 11" Mack Escutcheon</b>  <b>Profile Cylinder</b>                      E21046 / E21046 Entry Trim* ..... \$ 1,007                      E21041 / E21046 Patio Trim* ..... \$ 929                      E21041 / E21041 Full Dummy ..... \$ 697</p> <ul style="list-style-type: none"> <li>• Entry Trim includes Profile cylinder and turn piece.</li> <li>• Patio Trim includes 1/2 Profile cylinder and turn piece.</li> </ul> <p>* The center to center dimension will need to be verified before set can be ordered.</p>
 <p>E21041 E21046</p>		

- Price includes your choice of lever. (Knobs and rings are not recommended for multi-point combinations.) Call RMH for pricing.
- Combinations are shown with L21005 Emile Lever for illustrations purposes only. Refer to Section A for desired lever.
- Entry, Patio, and Passage functions include 8mm spindle.
- Specify metal, patina, handing, backset, door thickness, lock type, and center-to-center dimension.
- Refer to Section B for Escutcheon Specifications.

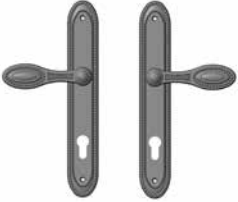
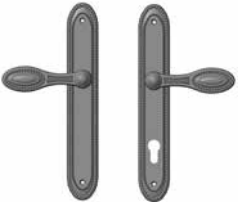
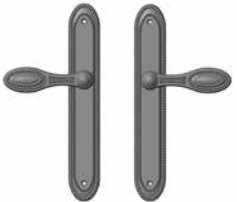
	ACTIVE	DUMMY	ESCUTCHEON OPTIONS
<b>A</b>	 E21045 E21043	 E21041 E21041	<p><b>A 13/4" x 11" Mack Escutcheon</b>  <b>American Cylinder</b>                      E21045 / E21043 Entry Trim* ..... \$ 872                      E21041 / E21043 Patio Trim*..... \$ 816                      E21041 / E21041 Passage Trim..... \$ 762                      E21041 / E21041 Full Dummy ..... \$ 697</p> <ul style="list-style-type: none"> <li>• Entry Trim includes American cylinder and turn piece.</li> <li>• Patio Trim includes turn piece.</li> </ul>
	 E21041 E21043		
<b>B</b>	 E21044 E21042	 E21040 E21040	
	 E21040 E21042		





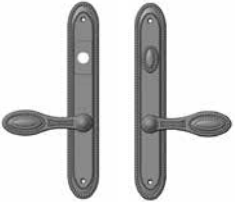
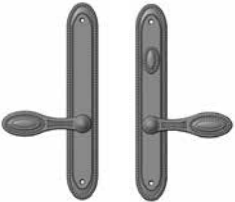
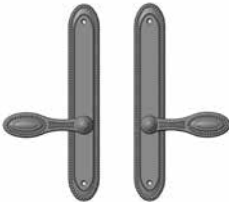

- Price includes your choice of lever. (Knobs and rings are not recommended for multi-point combinations.) Call RMH for pricing.
- Combinations are shown with L580 Maddox Lever for illustrations purposes only. Refer to Section A for desired lever.
- Entry, Patio, and Passage functions include 8mm spindle.
- Specify metal, patina, handing, backset, door thickness, lock type, and center-to-center dimension.
- Refer to Section B for Escutcheon Specifications.

	ACTIVE	DUMMY	ESCUTCHEON OPTIONS
<b>A</b>	 <p>E592 E592</p>		<p><b>A 13/4" x 11" Maddox Escutcheon Profile Cylinder</b></p> <p>E592 / E592 Entry Trim* ..... \$ 1,355</p> <p>E591 / E592 Patio Trim* ..... \$ 1,256</p> <p>E591 / E591 Full Dummy..... \$ 995</p> <ul style="list-style-type: none"> <li>• Entry Trim includes Profile cylinder and turn piece.</li> <li>• Patio Trim includes 1/2 Profile cylinder and turn piece.</li> </ul>
	 <p>E591 E592</p>	 <p>E591 E591</p>	
<b>B</b>	 <p>E595 E597</p>		<p><b>B 13/4" x 11" Maddox Escutcheon American Cylinder</b></p> <p>E595 / E597 Entry Trim* ..... \$ 1,208</p> <p>E591 / E597 Patio Trim* ..... \$ 1,126</p> <p>E591 / E591 Passage Trim ..... \$ 1,061</p> <p>E591 / E591 Full Dummy..... \$ 995</p> <ul style="list-style-type: none"> <li>• Entry Trim includes American cylinder and turn piece.</li> <li>• Patio Trim includes turn piece.</li> </ul> <p>* The center to center dimension will need to be verified before set can be ordered.</p>
	 <p>E591 E597</p>	 <p>E591 E591</p>	

- Price includes your choice of lever. (Knobs and rings are not recommended for multi-point combinations.) Call RMH for pricing.
- Combinations are shown with L580 Maddox Lever for illustrations purposes only. Refer to Section A for desired lever.
- Entry, Patio, and Passage functions include 8mm spindle.
- Specify metal, patina, handing, backset, door thickness, lock type, and center-to-center dimension.
- Refer to Section B for Escutcheon Specifications.

ACTIVE	DUMMY	ESCUTCHEON OPTIONS
<p><b>A</b></p>  <p>E594 E596</p>  <p>E590 E596</p>	 <p>E590 E590</p>	<p><b>A 1 3/4" x 11" Maddox Escutcheon</b></p> <p><b>American Cylinder</b></p> <p>E594 / E596 Entry Trim* ..... \$ 1,208</p> <p>E590 / E596 Patio Trim* ..... \$ 1,126</p> <p>E590 / E590 Passage Trim..... \$ 1,061</p> <p>E590 / E590 Full Dummy ..... \$ 995</p> <ul style="list-style-type: none"> <li>• Entry Trim includes American cylinder and turn piece.</li> <li>• Patio Trim includes turn piece.</li> </ul> <p>* The center to center dimension will need to be verified before set can be ordered.</p>

- Price includes your choice of lever. (Knobs and rings are not recommended for multi-point combinations.) Call RMH for pricing.
- Combinations are shown with L135 Olympus Lever for illustrations purposes only. Refer to Section A for desired lever.
- Entry, Patio, and Passage functions include 8mm spindle.
- Specify metal, patina, handing, backset, door thickness, lock type, and center-to-center dimension.
- Refer to Section B for Escutcheon Specifications.

	ACTIVE	DUMMY	ESCUTCHEON OPTIONS
<b>A</b>	 <p>E274 E274</p>		<p><b>A 13/8" x 11" Metro Escutcheon Profile Cylinder</b></p> <p>E274 / E274 Entry Trim* ..... \$ 976</p> <p>E270 / E274 Patio Trim* ..... \$ 899</p> <p>E270 / E270 Full Dummy ..... \$ 665</p> <ul style="list-style-type: none"> <li>• Entry Trim includes Profile cylinder and turn piece.</li> <li>• Patio Trim includes 1/2 Profile cylinder and turn piece.</li> </ul>
	 <p>E270 E274</p>	 <p>E270 E270</p>	
<b>B</b>	 <p>E270 E271</p>	 <p>E270 E270</p>	
<b>C</b>	 <p>E272 E273</p>	 <p>E272 E272</p>	<p><b>B 13/8" x 11" Metro Escutcheon American Cylinder</b></p> <p>E270 / E271 Patio Trim* ..... \$ 781</p> <p>E270 / E270 Passage Trim ..... \$ 714</p> <p>E270 / E270 Full Dummy ..... \$ 665</p> <ul style="list-style-type: none"> <li>• Patio Trim includes turn piece.</li> </ul> <p><b>C 13/8" x 11" Metro Escutcheon American Cylinder</b></p> <p>E272 / E273 Patio Trim* ..... \$ 781</p> <p>E272 / E272 Passage Trim ..... \$ 714</p> <p>E272 / E272 Full Dummy ..... \$ 665</p> <ul style="list-style-type: none"> <li>• Patio Trim includes turn piece.</li> </ul> <p>* The center to center dimension will need to be verified before set can be ordered.</p>

- Price includes your choice of lever. (Knobs and rings are not recommended for multi-point combinations.) Call RMH for pricing.
- Combinations are shown with L135 Olympus Lever for illustrations purposes only. Refer to Section A for desired lever.
- Entry, Patio, and Passage functions include 8mm spindle.
- Specify metal, patina, handing, backset, door thickness, lock type, and center-to-center dimension.
- Refer to Section B for Escutcheon Specifications.

ACTIVE

DUMMY

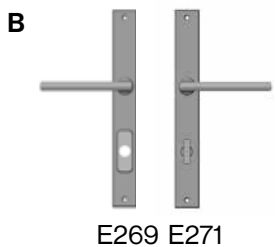
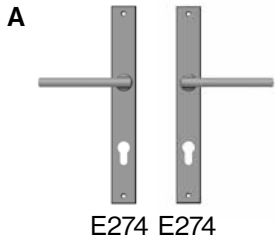

**A 13/8" x 11" Metro Escutcheon  
Profile Cylinder**

E274 / E274 Entry Trim*	\$ 976
E270 / E274 Patio Trim*	\$ 899
E270 / E270 Full Dummy	\$ 665

- Entry Trim includes Profile cylinder and turn piece.
- Patio Trim includes 1/2 Profile cylinder and turn piece.

**B 13/8" x 11" Metro Escutcheon  
American Cylinder**

E269 / E271 Entry Trim*	\$ 907
E270 / E271 Patio Trim*	\$ 781
E270 / E270 Passage Trim	\$ 714
E270 / E270 Full Dummy	\$ 665

- Entry Trim includes Profile cylinder and turn piece.
- Patio Trim includes turn piece.

\* The center to center dimension will need to be verified before set can be ordered.

- Price includes your choice of lever. (Knobs and rings are not recommended for multi-point combinations.) Call RMH for pricing.
- Combinations are shown with L135 Olympus Lever for illustrations purposes only. Refer to Section A for desired lever.
- Entry, Patio, and Passage functions include 8mm spindle.
- Specify metal, patina, handing, backset, door thickness, lock type, and center-to-center dimension.
- Refer to Section B for Escutcheon Specifications.

ACTIVE

DUMMY

C



E276 E273



E272 E273



E272 E272

**C 13/8" x 11" Metro Escutcheon  
American Cylinder**

E276 / E273 Entry Trim*	\$ 907
E272 / E273 Patio Trim*	\$ 781
E272 / E272 Passage Trim	\$ 714
E272 / E272 Full Dummy	\$ 665



- Entry Trim includes Profile cylinder and turn piece.
- Patio Trim includes turn piece.

\* The center to center dimension will need to be verified before set can be ordered.

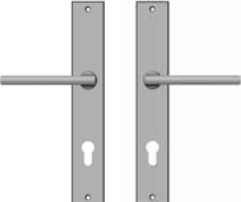
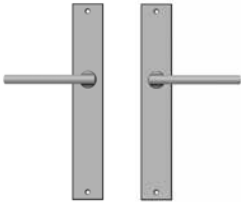
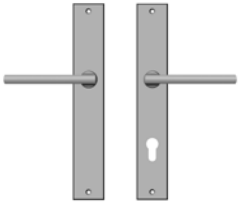
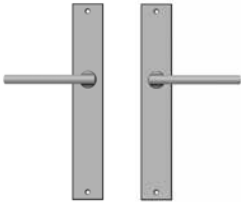
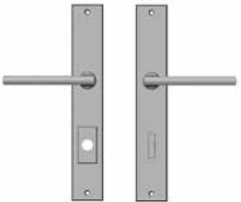
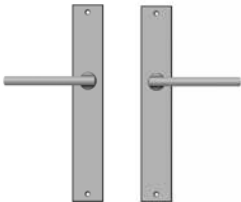
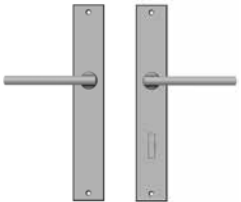
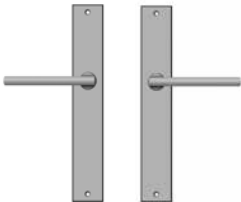



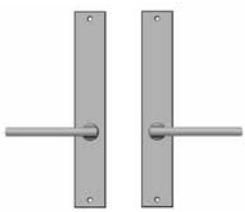

- Price includes your choice of lever. (Knobs and rings are not recommended for multi-point combinations.) Call RMH for pricing.
- Combinations are shown with L135 Olympus Lever for illustrations purposes only. Refer to Section A for desired lever.
- Entry, Patio, and Passage functions include 8mm spindle.
- Specify metal, patina, handing, backset, door thickness, lock type, and center-to-center dimension.
- Refer to Section B for Escutcheon Specifications.

ACTIVE	DUMMY	ESCUTCHEON OPTIONS
<p><b>A</b></p>  <p>E246 E246</p>	<p><b>DUMMY</b></p>  <p>E241 E241</p>	<p><b>A 13/4" x 11" Metro Escutcheon</b>  <b>Profile Cylinder</b>                      E246 / E246 Entry Trim* ..... \$ 1,007                      E241 / E246 Patio Trim* ..... \$ 929                      E241 / E241 Full Dummy ..... \$ 697</p> <ul style="list-style-type: none"> <li>• Entry Trim includes Profile cylinder and turn piece.</li> <li>• Patio Trim includes 1/2 Profile cylinder and turn piece.</li> </ul> <p><b>B 13/4" x 11" Metro Escutcheon</b>  <b>American Cylinder</b>                      E245 / E243 Entry Trim* ..... \$ 872                      E241 / E243 Patio Trim* ..... \$ 816                      E241 / E241 Passage Trim ..... \$ 762                      E241 / E241 Full Dummy ..... \$ 697</p> <ul style="list-style-type: none"> <li>• Entry Trim includes American cylinder and turn piece.</li> <li>• Patio Trim includes turn piece.</li> </ul> <p>* The center to center dimension will need to be verified before set can be ordered.</p>
 <p>E241 E246</p>	 <p>E241 E241</p>	
<p><b>B</b></p>  <p>E245 E243</p>	 <p>E241 E241</p>	
 <p>E241 E243</p>	 <p>E241 E241</p>	





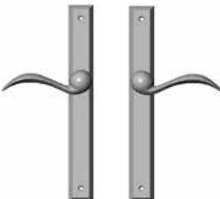

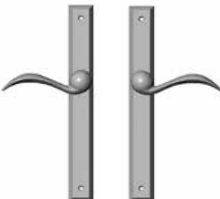
- Price includes your choice of lever. (Knobs and rings are not recommended for multi-point combinations.) Call RMH for pricing.
- Combinations are shown with L135 Olympus Lever for illustrations purposes only. Refer to Section A for desired lever.
- Entry, Patio, and Passage functions include 8mm spindle.
- Specify metal, patina, handing, backset, door thickness, lock type, and center-to-center dimension.
- Refer to Section B for Escutcheon Specifications.

	ACTIVE	DUMMY	ESCUTCHEON OPTIONS								
A	 <p>E244 E242</p>	 <p>E240 E240</p>	<p><b>A 13/4" x 11" Metro Escutcheon</b>  <b>American Cylinder</b></p> <table border="0"> <tr> <td>E244 / E242 Entry Trim*</td> <td>\$ 872</td> </tr> <tr> <td>E240 / E242 Patio Trim*</td> <td>\$ 816</td> </tr> <tr> <td>E240 / E240 Passage Trim</td> <td>\$ 762</td> </tr> <tr> <td>E240 / E240 Full Dummy</td> <td>\$ 697</td> </tr> </table> <ul style="list-style-type: none"> <li>• Entry Trim includes American cylinder and turn piece.</li> <li>• Patio Trim includes turn piece.</li> </ul> <p>* The center to center dimension will need to be verified before set can be ordered.</p>	E244 / E242 Entry Trim*	\$ 872	E240 / E242 Patio Trim*	\$ 816	E240 / E240 Passage Trim	\$ 762	E240 / E240 Full Dummy	\$ 697
	E244 / E242 Entry Trim*			\$ 872							
E240 / E242 Patio Trim*	\$ 816										
E240 / E240 Passage Trim	\$ 762										
E240 / E240 Full Dummy	\$ 697										
	 <p>E240 E242</p>										

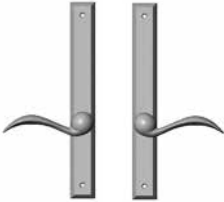

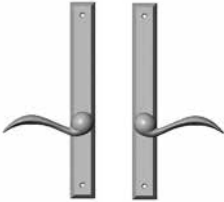

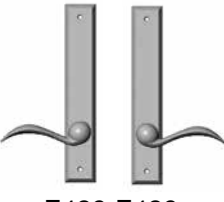

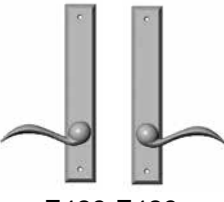
- Price includes your choice of lever. (Knobs and rings are not recommended for multi-point combinations.) Call RMH for pricing.
- Combinations are shown with L105 Beaver Tail Lever for illustrations purposes only. Refer to Section A for desired lever.
- Entry, Patio, and Passage functions include 8mm spindle.
- Specify metal, patina, handing, backset, door thickness, lock type, and center-to-center dimension.
- Refer to Section B for Escutcheon Specifications.

ACTIVE	DUMMY	ESCUTCHEON OPTIONS
<p><b>A</b></p>  <p>E455 E455</p>	 <p>E456 E456</p>	<p><b>A 13/8" x 11" Rectangular Escutcheon Profile Cylinder</b></p> <p>E455 / E455 Entry Trim* ..... \$ 976</p> <p>E456 / E455 Patio Trim* ..... \$ 899</p> <p>E456 / E456 Full Dummy ..... \$ 665</p> <ul style="list-style-type: none"> <li>• Entry Trim includes Profile cylinder and turn piece.</li> <li>• Patio Trim includes 1/2 Profile cylinder and turn piece.</li> </ul>
 <p>E456 E455</p>	 <p>E456 E456</p>	<p><b>B 13/8" x 11" Rectangular Escutcheon American Cylinder</b></p> <p>E481 / E487 Entry Trim* ..... \$ 840</p> <p>E456 / E487 Patio Trim* ..... \$ 781</p> <p>E456 / E456 Passage Trim ..... \$ 714</p> <p>E456 / E456 Full Dummy ..... \$ 665</p> <ul style="list-style-type: none"> <li>• Entry Trim includes American cylinder and turn piece.</li> <li>• Patio Trim includes turn piece.</li> </ul>
<p><b>B</b></p>  <p>E481 E487</p>	 <p>E456 E456</p>	<p>* The center to center dimension will need to be verified before set can be ordered.</p>
 <p>E456 E487</p>	 <p>E456 E456</p>	







- Price includes your choice of lever. (Knobs and rings are not recommended for multi-point combinations.) Call RMH for pricing.
- Combinations are shown with L105 Beaver Tail Lever for illustrations purposes only. Refer to Section A for desired lever.
- Entry, Patio, and Passage functions include 8mm spindle.
- Specify metal, patina, handing, backset, door thickness, lock type, and center-to-center dimension.
- Refer to Section B for Escutcheon Specifications.

ACTIVE	DUMMY	ESCUTCHEON OPTIONS
<p><b>A</b></p>  <p>E486 E488</p>	 <p>E489 E489</p>	<p><b>A 13/8" x 11" Rectangular Escutcheon</b>  <b>American Cylinder</b>                      E486 / E488 Entry Trim* .....\$ 840                      E489 / E488 Patio Trim* .....\$ 781                      E489 / E489 Passage Trim.....\$ 714                      E489 / E489 Full Dummy .....\$ 665</p> <ul style="list-style-type: none"> <li>• Entry Trim includes American cylinder and turn piece.</li> <li>• Patio Trim includes turn piece.</li> </ul>
 <p>E489 E488</p>	 <p>E489 E489</p>	<p><b>B 13/4" x 10" Rectangular Escutcheon (105 mm c-to-c)</b>  <b>American Cylinder</b>                      E425 / E427 Entry Trim* .....\$ 872                      E426 / E427 Patio Trim* .....\$ 816                      E426 / E426 Passage Trim.....\$ 762                      E426 / E426 Full Dummy .....\$ 697</p> <ul style="list-style-type: none"> <li>• Entry Trim includes American cylinder and turn piece.</li> <li>• Patio Trim includes turn piece.</li> </ul>
<p><b>B</b></p>  <p>E425 E427</p>	 <p>E426 E426</p>	<p>* The center to center dimension will need to be verified before set can be ordered.</p>
 <p>E426 E427</p>	 <p>E426 E426</p>	





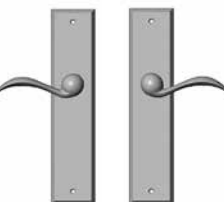

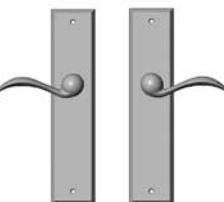





- Price includes your choice of lever. (Knobs and rings are not recommended for multi-point combinations.) Call RMH for pricing.
- Combinations are shown with L105 Beaver Tail Lever for illustrations purposes only. Refer to Section A for desired lever.
- Entry, Patio, and Passage functions include 8mm spindle.
- Specify metal, patina, handing, backset, door thickness, lock type, and center-to-center dimension.
- Refer to Section B for Escutcheon Specifications.

	ACTIVE	DUMMY	ESCUTCHEON OPTIONS	
<b>A</b>			<b>A 13/4" x 11" Rectangular Escutcheon Profile Cylinder</b> E448 / E448 Entry Trim* ..... \$ 1,007 E446 / E448 Patio Trim* ..... \$ 929 E446 / E446 Full Dummy ..... \$ 697 • Entry Trim includes Profile cylinder and turn piece. • Patio Trim includes 1/2 Profile cylinder and turn piece.	
	E448 E448			
				<b>B 13/4" x 11" Rectangular Escutcheon American Cylinder</b> E445 / E447 Entry Trim* ..... \$ 872 E446 / E447 Patio Trim* ..... \$ 816 E446 / E446 Passage Trim ..... \$ 762 E446 / E446 Full Dummy ..... \$ 697 • Entry Trim includes American cylinder and turn piece. • Patio Trim includes turn piece.
	E446 E448	E446 E446		
<b>B</b>			* The center to center dimension will need to be verified before set can be ordered.	
	E445 E447			
				
	E446 E447	E446 E446		

- Price includes your choice of lever. (Knobs and rings are not recommended for multi-point combinations.) Call RMH for pricing.
- Combinations are shown with L105 Beaver Tail Lever for illustrations purposes only. Refer to Section A for desired lever.
- Entry, Patio, and Passage functions include 8mm spindle.
- Specify metal, patina, handing, backset, door thickness, lock type, and center-to-center dimension.
- Refer to Section B for Escutcheon Specifications.

ACTIVE	DUMMY	ESCUTCHEON OPTIONS
<p><b>A</b></p>  <p>E443 E442</p>	<p><b>DUMMY</b></p>  <p>E441 E441</p>	<p><b>A 1 3/4" x 11" Rectangular Escutcheon</b>  <b>American Cylinder</b>                      E443 / E442 Entry Trim* ..... \$ 872                      E441 / E442 Patio Trim* ..... \$ 816                      E441 / E441 Passage Trim ..... \$ 762                      E441 / E441 Full Dummy..... \$ 697</p> <ul style="list-style-type: none"> <li>• Entry Trim includes American cylinder and turn piece.</li> <li>• Patio Trim includes turn piece.</li> </ul>
 <p>E441 E442</p>	 <p>E441 E441</p>	<p><b>B 2 1/2" x 11" Rectangular Escutcheon</b>  <b>Profile Cylinder</b>                      E457 / E457 Entry Trim* ..... \$ 1,007                      E451 / E457 Patio Trim* ..... \$ 929                      E451 / E451 Full Dummy..... \$ 697</p> <ul style="list-style-type: none"> <li>• Entry Trim includes Profile cylinder and turn piece.</li> <li>• Patio Trim includes 1/2 Profile cylinder and turn piece.</li> </ul>
<p><b>B</b></p>  <p>E457 E457</p>	 <p>E451 E451</p>	<p>* The center to center dimension will need to be verified before set can be ordered.</p>
 <p>E451 E457</p>	 <p>E451 E451</p>	

- Price includes your choice of lever. (Knobs and rings are not recommended for multi-point combinations.) Call RMH for pricing.
- Combinations are shown with L105 Beaver Tail Lever for illustrations purposes only. Refer to Section A for desired lever.
- Entry, Patio, and Passage functions include 8mm spindle.
- Specify metal, patina, handing, backset, door thickness, lock type, and center-to-center dimension.
- Refer to Section B for Escutcheon Specifications.

	ACTIVE	DUMMY	ESCUTCHEON OPTIONS
<b>A</b>			<p><b>A 2 1/2" x 11" Rectangular Escutcheon</b>  <b>American Cylinder</b>                      E450 / E453 Entry Trim* ..... \$ 872                      E451 / E453 Patio Trim* ..... \$ 816                      E451 / E451 Passage Trim..... \$ 762                      E451 / E451 Full Dummy..... \$ 697</p> <ul style="list-style-type: none"> <li>• Entry Trim includes American cylinder and turn piece.</li> <li>• Patio Trim includes turn piece.</li> </ul>
	E450	E453	
			
	E451	E453	
<b>B</b>			<p><b>B 2 1/2" x 11" Rectangular Escutcheon</b>  <b>American Cylinder</b>                      E459 / E458 Entry Trim* ..... \$ 872                      E452 / E458 Patio Trim* ..... \$ 816                      E452 / E452 Passage Trim ..... \$ 762                      E452 / E452 Full Dummy ..... \$ 697</p> <ul style="list-style-type: none"> <li>• Entry Trim includes American cylinder and turn piece.</li> <li>• Patio Trim includes turn piece.</li> </ul> <p>* The center to center dimension will need to be verified before set can be ordered.</p>
	E459	E458	
			
	E452	E458	
			
			
		E451	E451
			
			
		E452	E452

- Price includes your choice of lever. (Knobs and rings are not recommended for multi-point combinations.) Call RMH for pricing.
- Combinations are shown with L135 Olympus Lever for illustrations purposes only. Refer to Section A for desired lever.
- Entry, Patio, and Passage functions include 8mm spindle.
- Specify metal, patina, handing, backset, door thickness, lock type, and center-to-center dimension.
- Refer to Section B for Escutcheon Specifications.

ACTIVE

DUMMY

ESCUTCHEON OPTIONS

**A**



E375 E375



E376 E375

**B**



E378 E377



E376 E377



E376 E376



E376 E376

**A 1 3/8" x 11" Stepped Escutcheon**

**Profile Cylinder**

E375 / E375 Entry Trim*	\$ 976
E376 / E375 Patio Trim*	\$ 899
E376 / E376 Full Dummy	\$ 665

- Entry Trim includes Profile cylinder and turn piece.
- Patio Trim includes 1/2 Profile cylinder and turn piece.



**B 1 3/8" x 11" Stepped Escutcheon**

**American Cylinder**







E378 / E377 Entry Trim*	\$907
E376 / E377 Patio Trim*	\$ 781
E376 / E376 Passage Trim	\$ 714
E376 / E376 Full Dummy	\$ 665

- Entry Trim includes Profile cylinder and turn piece.
- Patio Trim includes turn piece.

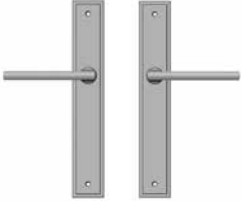

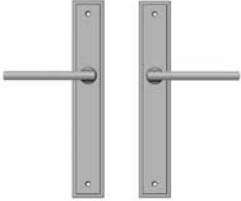
- Price includes your choice of lever. (Knobs and rings are not recommended for multi-point combinations.) Call RMH for pricing.
- Combinations are shown with L135 Olympus Lever for illustrations purposes only. Refer to Section A for desired lever.
- Entry, Patio, and Passage functions include 8mm spindle.
- Specify metal, patina, handing, backset, door thickness, lock type, and center-to-center dimension.
- Refer to Section B for Escutcheon Specifications.

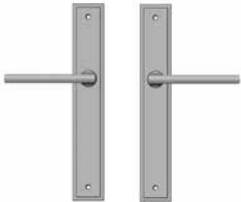
ACTIVE	DUMMY	ESCUTCHEON OPTIONS								
<p><b>C</b></p>  <p>E329 E328</p>  <p>E327 E328</p>	 <p>E327 E327</p>	<p><b>C 13/8" x 11" Stepped Escutcheon</b>                  ..... <b>American Cylinder</b></p> <table border="0"> <tr> <td>E329 / E328 Entry Trim*</td> <td>\$907</td> </tr> <tr> <td>E327 / E328 Patio Trim*</td> <td>\$781</td> </tr> <tr> <td>E327 / E327 Passage Trim</td> <td>\$714</td> </tr> <tr> <td>E327 / E327 Full Dummy.....</td> <td>\$665</td> </tr> </table> <ul style="list-style-type: none"> <li>• Entry Trim includes Profile cylinder and turn piece.</li> <li>• Patio Trim includes turn piece.</li> </ul> <p>* The center to center dimension will need to be verified before set can be ordered.</p>	E329 / E328 Entry Trim*	\$907	E327 / E328 Patio Trim*	\$781	E327 / E327 Passage Trim	\$714	E327 / E327 Full Dummy.....	\$665
E329 / E328 Entry Trim*	\$907									
E327 / E328 Patio Trim*	\$781									
E327 / E327 Passage Trim	\$714									
E327 / E327 Full Dummy.....	\$665									

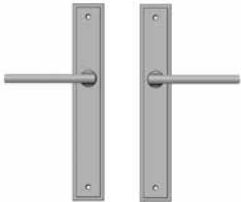
- Price includes your choice of lever. (Knobs and rings are not recommended for multi-point combinations.) Call RMH for pricing.
- Combinations are shown with L135 Olympus Lever for illustrations purposes only. Refer to Section A for desired lever.
- Entry, Patio, and Passage functions include 8mm spindle.
- Specify metal, patina, handing, backset, door thickness, lock type, and center-to-center dimension.
- Refer to Section B for Escutcheon Specifications.

ACTIVE	DUMMY	ESCUTCHEON OPTIONS
<p><b>A</b></p>  <p>E332 E332</p>	 <p>E330 E330</p>	<p><b>A 13/4" x 11" Stepped Escutcheon</b>  <b>Profile Cylinder</b>                      E332 / E332 Entry Trim* ..... \$ 1,007                      E330 / E332 Patio Trim* ..... \$ 929                      E330 / E330 Full Dummy ..... \$ 697</p> <ul style="list-style-type: none"> <li>• Entry Trim includes Profile cylinder and turn piece.</li> <li>• Patio Trim includes 1/2 Profile cylinder and turn piece.</li> </ul> <p><b>B 13/4" x 11" Stepped Escutcheon</b>  <b>American Cylinder</b>                      E338 / E336 Entry Trim* ..... \$ 872                      E330 / E336 Patio Trim* ..... \$ 816                      E330 / E330 Passage Trim ..... \$ 762                      E330 / E330 Full Dummy ..... \$ 697</p> <ul style="list-style-type: none"> <li>• Entry Trim includes American cylinder and turn piece.</li> <li>• Patio Trim includes turn piece.</li> </ul> <p>* The center to center dimension will need to be verified before set can be ordered.</p>
 <p>E330 E332</p>	 <p>E330 E330</p>	
<p><b>B</b></p>  <p>E338 E336</p>	 <p>E330 E330</p>	
 <p>E330 E336</p>	 <p>E330 E330</p>	

- Price includes your choice of lever. (Knobs and rings are not recommended for multi-point combinations.) Call RMH for pricing.
- Combinations are shown with L135 Olympus Lever for illustrations purposes only. Refer to Section A for desired lever.
- Entry, Patio, and Passage functions include 8mm spindle.
- Specify metal, patina, handing, backset, door thickness, lock type, and center-to-center dimension.
- Refer to Section B for Escutcheon Specifications.

ACTIVE	DUMMY	ESCUTCHEON OPTIONS								
<p><b>A</b></p>  <p>E339 E337</p>  <p>E331 E337</p>	 <p>E331 E331</p>	<p><b>A 13/4" x 11" Stepped Escutcheon</b>  <b>American Cylinder</b></p> <table border="0"> <tr> <td>E339 / E337 Entry Trim*</td> <td>\$ 872</td> </tr> <tr> <td>E331 / E337 Patio Trim*</td> <td>\$ 816</td> </tr> <tr> <td>E331 / E331 Passage Trim</td> <td>\$ 762</td> </tr> <tr> <td>E331 / E331 Full Dummy</td> <td>\$ 697</td> </tr> </table> <ul style="list-style-type: none"> <li>• Entry Trim includes American cylinder and turn piece.</li> <li>• Patio Trim includes turn piece.</li> </ul> <p>* The center to center dimension will need to be verified before set can be ordered.</p>	E339 / E337 Entry Trim*	\$ 872	E331 / E337 Patio Trim*	\$ 816	E331 / E331 Passage Trim	\$ 762	E331 / E331 Full Dummy	\$ 697
E339 / E337 Entry Trim*	\$ 872									
E331 / E337 Patio Trim*	\$ 816									
E331 / E331 Passage Trim	\$ 762									
E331 / E331 Full Dummy	\$ 697									

- Price includes your choice of lever. (Knobs and rings are not recommended for multi-point combinations.) Call RMH for pricing.
- Combinations are shown with L30301 Trousdale Lever for illustrations purposes only. Refer to Section A for desired lever.
- Entry, Patio, and Passage functions include 8mm spindle.
- Specify metal, patina, handing, backset, door thickness, lock type, and center-to-center dimension.
- Refer to Section B for Escutcheon Specifications.

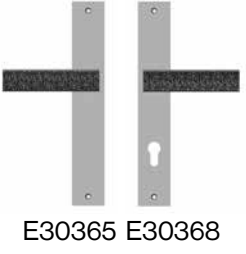
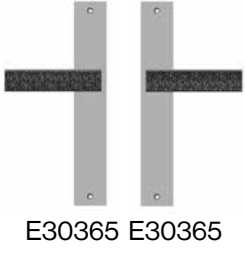
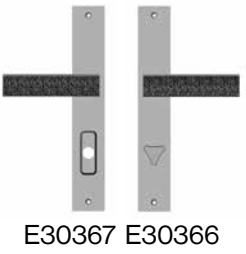
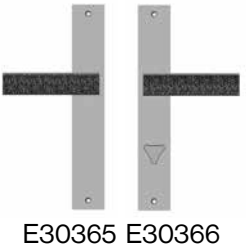
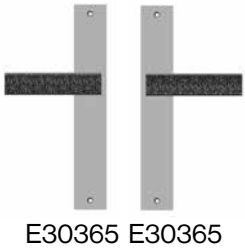
	ACTIVE	DUMMY	ESCUTCHEON OPTIONS
<b>A</b>	 <p>E30368 E30368</p>		<p><b>A 13/4" x 11" Trousdale Escutcheon</b>  <b>Profile Cylinder</b>                      Kravitz Design Collection                      E30368 / E30368 Entry Trim* ..... \$ 1,355                      E30365 / E30368 Patio Trim* ..... \$ 1,256                      E30365 / E30365 Full Dummy ..... \$ 995</p> <ul style="list-style-type: none"> <li>• Entry Trim includes Profile cylinder and turn piece.</li> <li>• Patio Trim includes 1/2 Profile cylinder and turn piece.</li> </ul> <p><b>B 13/4" x 11" Trousdale Escutcheon</b>  <b>American Cylinder</b>                      Kravitz Design Collection                      E30367 / E30366 Entry Trim* ..... \$ 1,208                      E30365 / E30366 Patio Trim* ..... \$ 1,126                      E30365 / E30365 Passage Trim ..... \$ 1,061                      E30365 / E30365 Full Dummy ..... \$ 995</p> <ul style="list-style-type: none"> <li>• Entry Trim includes American cylinder and turn piece.</li> <li>• Patio Trim includes turn piece.</li> </ul> <p>* The center to center dimension will need to be verified before set can be ordered.</p>
	 <p>E30365 E30368</p>	 <p>E30365 E30365</p>	
<b>B</b>	 <p>E30367 E30366</p>		
	 <p>E30365 E30366</p>	 <p>E30365 E30365</p>	

- Price includes your choice of lever. (Knobs and rings are not recommended for multi-point combinations.) Call RMH for pricing.
- Combinations are shown with L30301 Trousdale Lever for illustrations purposes only. Refer to Section A for desired lever.
- Entry, Patio, and Passage functions include 8mm spindle.
- Specify metal, patina, handing, backset, door thickness, lock type, and center-to-center dimension.
- Refer to Section B for Escutcheon Specifications.

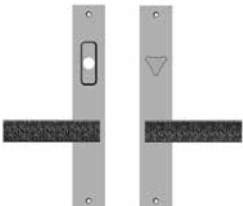
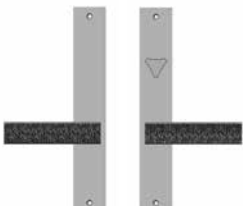
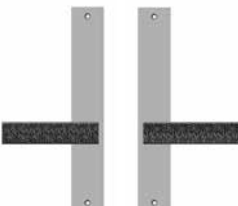
ACTIVE	DUMMY	ESCUTCHEON OPTIONS								
<p><b>A</b></p>  <p>E30363 E30362</p>  <p>E30361 E30362</p>	 <p>E30361 E30361</p>	<p><b>A 13/4" x 11" Trousdale Escutcheon</b>  <b>American Cylinder</b>                  Kravitz Design Collection</p> <table border="0"> <tr> <td>E30363 / E30362 Entry Trim*</td> <td>\$ 1,208</td> </tr> <tr> <td>E30361 / E30362 Patio Trim*</td> <td>\$ 1,126</td> </tr> <tr> <td>E30361 / E30361 Passage Trim</td> <td>\$ 1,061</td> </tr> <tr> <td>E30361 / E30361 Full Dummy</td> <td>\$ 995</td> </tr> </table> <ul style="list-style-type: none"> <li>• Entry Trim includes American cylinder and turn piece.</li> <li>• Patio Trim includes turn piece.</li> </ul> <p>* The center to center dimension will need to be verified before set can be ordered.</p>	E30363 / E30362 Entry Trim*	\$ 1,208	E30361 / E30362 Patio Trim*	\$ 1,126	E30361 / E30361 Passage Trim	\$ 1,061	E30361 / E30361 Full Dummy	\$ 995
E30363 / E30362 Entry Trim*	\$ 1,208									
E30361 / E30362 Patio Trim*	\$ 1,126									
E30361 / E30361 Passage Trim	\$ 1,061									
E30361 / E30361 Full Dummy	\$ 995									

---

ROCKY MOUNTAIN®  
H A R D W A R E

1020 Airport Way Hailey, Idaho 83333 USA  
toll free 888.788.2013 • ph. 208.788.2013 • fax 208.788.2577  
info@rockymountainhardware.com  
www.rockymountainhardware.com