

**Sample Order / Cheat Sheet**  
**E Patio Sets**

1/3

QUOTE     ORDER

NAME: \_\_\_\_\_

PO# \_\_\_\_\_

ADDRESS: \_\_\_\_\_

DELIVERY: \_\_\_\_\_

ADDRESS: \_\_\_\_\_



ORDER DATE: \_\_\_\_\_

OFFICE PHONE: \_\_\_\_\_

CONTACT: \_\_\_\_\_

FAX PHONE: \_\_\_\_\_

JOB NAME: \_\_\_\_\_

JOB PHONE: \_\_\_\_\_

**HARDWARE WORK ORDER**  
 Toll Free 888.788.2013 or 208.788.2013; Fax 208.788.2577

2002.12.04

LINE NO.	FUNCTION	HANDLE		ESCUTCHEON		METAL	PATINA	HANDING OR LENGTH	BACKSET	DOOR THICKNESS	LOCK TYPE	DEAD BOLT TRIM	DESCRIPTION	LOCATION #	QTY.	PRICE QUOTED
		EXTERIOR	INTERIOR	EXTERIOR	INTERIOR											
1	PO	L103	L103	E416	E416	B	R	R	238	134	DB	IP418		1	\$ 904	
2	PO	K203	K203	E408	E431	B	D	L	234	134	DB			2	\$ 1065	
3	PO	K201	K201	E460	E463	W	D	R	212	134	ML			3	\$ 1371	
4	PO-DB					B	L		234		DB	IP716		5	\$ 315	

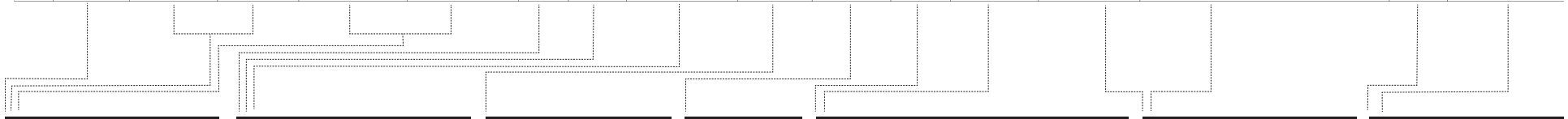

**FUNCTION**  
 PO = Patio  
 DU = Dummy  
 PO-DB = Patio Dead Bolt

**METAL**  
 B = Silicon Bronze  
 W = White Bronze

**BACKSET**  
 238 = 2 3/8" DB  
 212 = 2 1/2" ML  
 234 = 2 3/4" DB, ML

**DOOR THICKNESS**  
 138 = 1 3/8"  
 112 = 1 1/2"  
 134 = 1 3/4"  
 178 = 1 7/8"  
 2 = 2"  
 214 = 2 1/4"

**LOCK TYPE**  
 Complete Sets  
 DB = Dead Bolt  
 ML = Mortise Lock  
 DL = Dead Lock

**DESCRIPTION**  
 See page Eiii for options

**QTY**  
 Number of each desired

**HANDLE**  
 For a list of Levers, Knobs, and Rings available for Patio Door Sets, see next page.  
 For specifications, refer to Section A.

**PATINA**  
 L = Light  
 M = Medium  
 D = Dark  
 R = Rust  
 BB = Brushed  
 DL = Dark Lustre  
 HP = High Polished \*  
 \*Up-charge applies.

Up-charge for sizes below.  
 Call for pricing.  
 114 = 1 1/4" ML  
 112 = 1 1/2" ML  
 134 = 1 3/4" ML  
 2 = 2" ML  
 214 = 2 1/4" ML  
 334 = 3 3/4" ML  
 5 = 5" ML  
 6 = 6" ML  
 N = No

Up-charge for sizes below.  
 Call for pricing.  
 212 = 2 1/2"  
 258 = 2 5/8"  
 234 = 2 3/4"  
 3 = 3"  
 314 = 3 1/4"  
 312 = 3 1/2"  
 4 = 4"  
 N = No

**DEAD BOLT TRIM**  
 For a list of Dead Bolt Trim available for Patio Door Sets, see page E iii.  
 For configurations, specifications, and pricing, refer to content of this section.

**LOCATION #**  
 Room Number or Door Number, etc.

**PRICE**  
 \$ List price each

**ESCUTCHEONS**  
 For a list of Escutcheons available for Patio Door Sets, see next page.  
 For configurations, specifications, and pricing, refer to content of this section.

**HANDING**  
 See Hinged Door Handing diagram, next page.  
 L = Left Hand  
 R = Right Hand  
 LR = Left Hand Reverse  
 RR = Right Hand Reverse

<b>HANDLE</b>	<b>Levers (Continued)</b>	<b>Knobs (Continued)</b>	<b>Briggs (Continued)</b>	<b>Fleur de Lis</b>
Levers	L219 = Long Legacy Return Lever	K219 = Carriage Knob	E10800 = 2 3/8" x 7" Briggs	E820 = 2" x 15" Fleur de Lis
L075 = Ellis Lever	L224 = Ridge Lever	K230 = Acanthus Knob	E10810 = 2 3/8" x 10" Briggs	E821 = 2" x 15" Fleur de Lis (TP)
L101 = Longhorn Lever	L228 = Large Ridge Lever	K233 = Large Acanthus Knob	E10831 = 3" x 13" Briggs	E841 = 2 1/2" x 15" Fleur de Lis
L102 = Squirrel Tail Lever	L241 = Large French Lever	K235 = Cross Knob	E10832 = 3" x 13" Briggs (TP)	E842 = 2 1/2" x 15" Fleur de Lis (TP)
L103 = Chub Lever	L245 = French Return Lever	K236 = Ore Knob	E10834 = 3" x 13" Briggs	E832 = 3" x 21" Fleur de Lis
L104 = Hook Lever	L260 = Trolley Lever	K251 = Roswell Knob	E10835 = 3" x 13" Briggs (TP)	E831 = 3" x 21" Fleur de Lis (TP)
L105 = Beaver Tail Lever	L261 = Rail Lever	K268 = Squash Knob		
L106 = Talon Lever	L265 = I Beam Lever	K580 = Maddox Knob	<b>Convex</b>	<b>Hammered</b>
L107 = Slugger Lever	L267 = Cross Lever	K10010 = Quatrafoil Knob	E30503 = 2 1/2" x 4 1/2" Convex	E30403 = 2 1/2" x 4 1/2" Hammered
L108 = Tube Lever	L276 = Falcon Lever	K10015 = Octagonal Knob	E30506 = 2 1/2" x 8" Convex	E30406 = 2 1/2" x 8" Hammered
L109 = Legacy Lever	L301 = Strap Lever	K10020 = Flute Knob	E30505 = 2 1/2" x 8" Convex (TP)	E30407 = 2 1/2" x 8" Hammered (TP)
L110 = Classic Lever	L302 = Large Strap Lever	K10300 = Flora Knob	E30508 = 2 1/2" x 10" Convex	E30410 = 2 1/2" x 10" Hammered
L111 = Twig Lever	L303 = Boiler Lever	K10801 = Sundial Knob	E30509 = 2 1/2" x 10" Convex (TP)	E30411 = 2 1/2" x 10" Hammered (TP)
L112 = Large Chub Lever	L304 = Reed Lever	K10802 = Kettle Knob		
L113 = Carriage Lever	L307 = Jane Lever	K21001 = Mack Knob	<b>Corbel Arched</b>	<b>Mack</b>
L115 = Acanthus Lever	L308 = Long Jane Lever	K30144 = Smith Knob	E30603 = 2 1/2" x 4 1/2" Corbel	E21005 = 2 1/2" x 4 1/2" Mack
L116 = Herron Lever	L310 = Pool Lever	K30164 = Crown Knob	E30606 = 2 1/2" x 9" Corbel	E21056 = 2 1/2" x 10" Mack
L117 = French Lever	L311 = Blade Lever	K30184 = Cabernet Knob	E30607 = 2 1/2" x 9" Corbel (TP)	E21057 = 2 1/2" x 10" Mack (TP)
L118 = French Twist Lever	L314 = UJ Lever	K30301 = Trousdale Knob	Corbel Rectangular	E21060 = 3 3/4" x 15" Mack
L119 = Long Legacy Lever	L330 = Coupler Lever	T300 = T Handle	E30703 = 2 1/2" x 4 1/2" Corbel	E21063 = 3 3/4" x 15" Mack (TP)
L120 = Long French Lever	L580 = Maddox Lever		E30706 = 2 1/2" x 9" Corbel	
L121 = Rock Creek Lever	L10010 = Paris Lever	<b>Rings</b>	E30707 = 2 1/2" x 9" Corbel (TP)	<b>Maddox</b>
L122 = Large Hook Lever	L10015 = Flute Lever	RP25 = Ring Pull 2 1/2"		E589 = 3 1/8" Round*
L123 = Old World Lever	L10302 = Raleigh Lever	RP3 = Ring Pull 3"	<b>Curved</b>	E588 = 2 3/8" x 7 1/2" Maddox
L125 = Classic Scroll Lever	L10501 = Verdura Lever**	RP4 = Ring Pull 4"	E504 = 2 1/2" x 4 1/2" Curved	E585 = 2 1/2" x 10" Maddox
L126 = Triple Twist Lever	L10502 = Verdura Return Lever**		E508 = 2 1/2" x 8" Curved	E587 = 2 1/2" x 10" Maddox (TP)
L127 = Scroll Lever	L10801 = Briggs Lever	<b>ESCUTCHEONS</b>	E506 = 2 1/2" x 8" Curved (TP)	E584 = 3" x 12 1/2" Maddox
L128 = Small Classic Lever	L10802 = Kettle Lever	Arched-Rnd-Oval	E512 = 2 1/2" x 11" Curved	E582 = 3" x 12 1/2" Maddox (TP)
L129 = Trundle Lever	L20230 = Shift Lever	E417 = 2 1/2" Round*	E513 = 2 1/2" x 11" Curved (TP)	E570 = 3" x 15" Maddox
L130 = Monarch Lever	L21005 = Emile Lever	E418 = 3 1/4" Round*	E556 = 2 1/2" x 13" Curved	E571 = 3" x 15" Maddox (TP)
L131 = Large Monarch Lever	L30140 = Smith Lever	E501 = 2 5/8" x 5 1/4" Oval	E557 = 2 1/2" x 13" Curved (TP)	
L132 = Square Twist Lever	L30142 = Whittle Lever	E540 = 2 1/2" x 10" Oval		<b>Designer</b>
L135 = Olympus Lever	L30160 = Crown Lever	E541 = 2 1/2" x 10" Oval (TP)		E101 = 3 1/2" Round*
L137 = Olympus Return Lever	L30161 = Capitol Lever	E701 = 2 1/2" x 5 1/2" Arched		E103 = 3" x 3" Square*
L140 = Harrington Lever	L30180 = Chateau Lever	E702 = 2 1/2" x 9" Arched		E110 = 3" x 8" Designer
L141 = Large Rock Creek Lever	L30301 = Trousdale Lever	E723 = 2 1/2" x 9" Arched (TP)		E112 = 3" x 8" Designer (TP)
L147 = Large Olympus Lever		E704 = 2 1/2" x 11" Arched		E115 = 3" x 10" Designer
L150 = Bella Lever	<b>Knobs</b>	E721 = 2 1/2" x 11" Arched (TP)		E116 = 3" x 10" Designer (TP)
L151 = Large Harrington Lever	K075 = Ellis Knob	E736 = 2 1/2" x 13" Arched		
L152 = Osprey Lever	K150 = Oval Crystal Knob	E737 = 2 1/2" x 13" Arched (TP)		<b>Edge</b>
L153 = Talon Return Lever	K151 = Oval Cast Glass Knob	E706 = 3" x 13" Arched		E153 = 2" x 3" Edge*
L154 = Stalk Lever	K155 = Round Crystal Knob	E728 = 3" x 13" Arched (TP)		E160 = 2" x 8" Edge
L156 = Large Scroll Lever	K156 = Round Cast Glass Knob			E162 = 2" x 8" Edge (TP)
L158 = Large Acanthus Lever	K200 = Plymouth Knob	<b>Bordeaux</b>		E165 = 2" x 10" Edge
L159 = Baton Lever	K201 = Mushroom Knob	E30802 = 2 1/2" Round*		E166 = 2" x 10" Edge (TP)
L160 = Wing Lever	K202 = Hitch Knob	E30803 = 3 1/4" Round*		E170 = 2" x 13" Edge
L163 = Euro Lever	K203 = Potato Knob	E30806 = 2 1/2" x 5 1/2" Oval		E171 = 2" x 13" Edge (TP)
L164 = Chiseled Lever	K204 = Egg Knob	E30804 = 2 1/2" x 4 1/2" Bordeaux		
L174 = Lariat Lever	K205 = Baker Knob	E30805 = 2 1/2" x 6" Bordeaux		<b>Element</b>
L175 = Bamboo Lever	K206 = Large Luna Knob	E30810 = 2 1/2" x 16 7/16" Bordeaux		E10101 = 11/8" Round
L179 = Twig Return Lever	K207 = Luna Knob	E30811 = 2 1/2" x 16 7/16" Bordeaux (TP)		
L182 = Ribbon & Reed Lever	K208 = Gem Knob			<b>Ellis</b>
L185 = Ore Lever	K209 = Cottage Knob	<b>Briggs</b>		E005 = 3" x 5" Ellis
L216 = Old World Return Lever	K210 = Prairie Knob	E10820 = 2 1/2" Round*		E056 = 3" x 11" Ellis
	K218 = Elliptic Knob	E10871 = 2" x 15" Briggs		E057 = 3" x 11" Ellis (TP)
		E10877 = 2" x 15" Briggs (TP)		E060 = 3" x 13" Ellis
				E063 = 3" x 13" Ellis (TP)

(Escutcheons continued on next page)

Key

(TP) = Turn Piece Escutcheon

\* Not recommended for use with knobs.

\*\* Only available with Verdura escutcheons.

## Sample Order / Cheat Sheet

## E Patio Sets

3/3

**ESCUTCHEONS** (continued)**Oasis**

- E10155 = 3" x 4 1/4" Oasis  
 E10203 = 2 1/2" x 2 1/2" Square Oasis\*  
 E10205 = 2 1/2" x 4 1/2" Oasis  
 E10208 = 2 1/2" x 8 1/2" Oasis  
 E10209 = 2 1/2" x 8 1/2" Oasis (TP)  
 E10216 = 2 1/2" x 11" Oasis  
 E10217 = 2 1/2" x 11" Oasis (TP)

**Roger Thomas Paris Collection**

- E10015 = 2 1/2" x 9 1/4" Paris  
 E10016 = 2 1/2" x 9 1/4" Paris (TP)

**Rectangular-Sq-Dmnd**

- E416 = 2 5/8" x 2 5/8" Square\*  
 E415 = 3 9/16" x 3 9/16" Dmnd\*  
 E414 = 2 1/2" x 4 1/2" Rect  
 E410 = 2 1/2" x 8" Rect  
 E412 = 2 1/2" x 8" Rect (TP)  
 E408 = 2 1/2" x 10" Rect  
 E431 = 2 1/2" x 10" Rect (TP)  
 E436 = 2 1/2" x 13" Rect  
 E437 = 2 1/2" x 13" Rect (TP)  
 E404 = 3" x 10" Rect  
 E421 = 3" x 10" Rect (TP)  
 E460 = 3 1/2" x 13" Rect  
 E463 = 3 1/2" x 13" Rect (TP)

**Stepped**

- E304 = 2 1/2" x 4 1/2" Stepped  
 E308 = 2 1/2" x 8" Stepped  
 E306 = 2 1/2" x 8" Stepped (TP)  
 E312 = 2 1/2" x 11" Stepped  
 E313 = 2 1/2" x 11" Stepped (TP)  
 E356 = 2 1/2" x 13" Stepped  
 E357 = 2 1/2" x 13" Stepped (TP)  
 E360 = 3 1/2" x 13" Stepped  
 E363 = 3 1/2" x 13" Stepped (TP)

**Trousdale**

- E30303 = 3" Square\*  
 E30305 = 3" x 6" Trousdale  
 E30310 = 3" x 10" Trousdale  
 E30311 = 3" x 10" Trousdale (TP)

**Verdura**

- E10520 = 3" x 3" Square\*  
 E10526 = 3" x 9" Verdura  
 E10527 = 3" x 9" Verdura (TP)

**Key**

(TP) = Turn Piece Escutcheon

\* Not recommended for use with knobs.

**DEAD BOLT TRIM**

- IP014 = 3" x 3 3/4" Ellis  
 IP150 = 2" x 3" Edge  
 IP203 = 2 1/4" Square Metro  
 IP205 = 2 1/4" Round Metro  
 IP214 = 2 1/4" x 3 1/4" Metro  
 IP250 = 2 1/2" x 3 1/4" Metro  
 IP318 = 2 1/2" x 3 1/8" Stepped  
 IP415 = 3 9/16" x 3 9/16" Diamond  
 IP417 = 2 5/8" Round  
 IP418 = 2 1/2" x 3" Rect  
 IP512 = 2 1/2" x 3 3/8" Curved  
 IP580 = 2 3/8" x 3 5/16" Maddox  
 IP716 = 2 1/2" x 3 3/4" Arched  
 IP10101 = Not Applicable Element  
 IP10150 = 2 9/16" x 3 7/16" Beatrix  
 IP10200 = 2 1/2" x 3 1/4" Morris  
 IP10800 = 2 1/2" x 5 1/8" Briggs  
 IP21014 = 2 1/2" x 3 1/2" Mack  
 IP30390 = 3" Square Trousdale  
 IP30490 = 2 1/2" x 3 1/4" Hammered  
 IP30590 = 2 1/2" x 3 1/4" Convex  
 IP30690 = 2 1/2" x 4 1/2" Corbel Arched  
 IP30790 = 2 1/2" x 4" Corbel Rect  
 IP30890 = 2 1/2" x 3 1/4" Bordeaux

**Options for "DESCRIPTION" column (pg Ei)****Leather Options**

- LBK = Black Leather  
 LBT = Brown Tapestry Leather  
 LBW = Brown Weave Leather  
 LCH = Chocolate Leather  
 LHA = Hazelnut Leather  
 LSP = Spice Leather  
 LWH = White Leather  
 LWI = Wine Leather

**Bronze Insert Options**

- BTW = Weave Insert  
 BFL = Flower Insert  
 BTD = Tide Insert  
 BWD = Wood Insert  
 BBR = Branch Insert  
 BBA = Basic Insert  
 BTF = Tuft Insert  
 BRT = Flute Insert

**Edge Collection Options**

- ETW = Weave  
 EWD = Wood  
 EBA = Basic  
 ETD = Tide  
 EWR = Wire  
 EMS = Moonscape

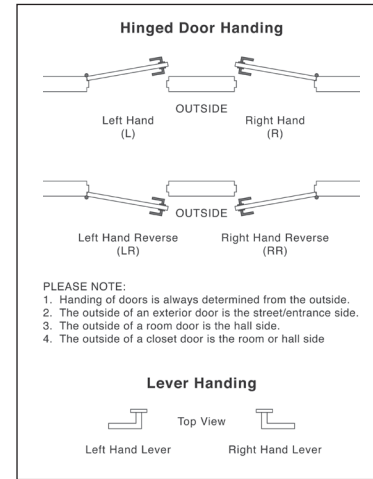
**HANDING**

Patio Spring Latch / Dead Bolt Set—Lever to Lever

- 1 Lever
- 2 Escutcheon
- 3 Turn Piece
- 4 Spring Latch
- 5 T-Strike
- 6 T-Strike Dust Box
- 7 Dead Bolt
- 8 Dead Bolt Strike
- 9 Dead Bolt Security Strike
- 10 Dead Bolt Dust Box
- 11 Spindle
- 12 Spindle Spring
- 13 Spindle Retainer

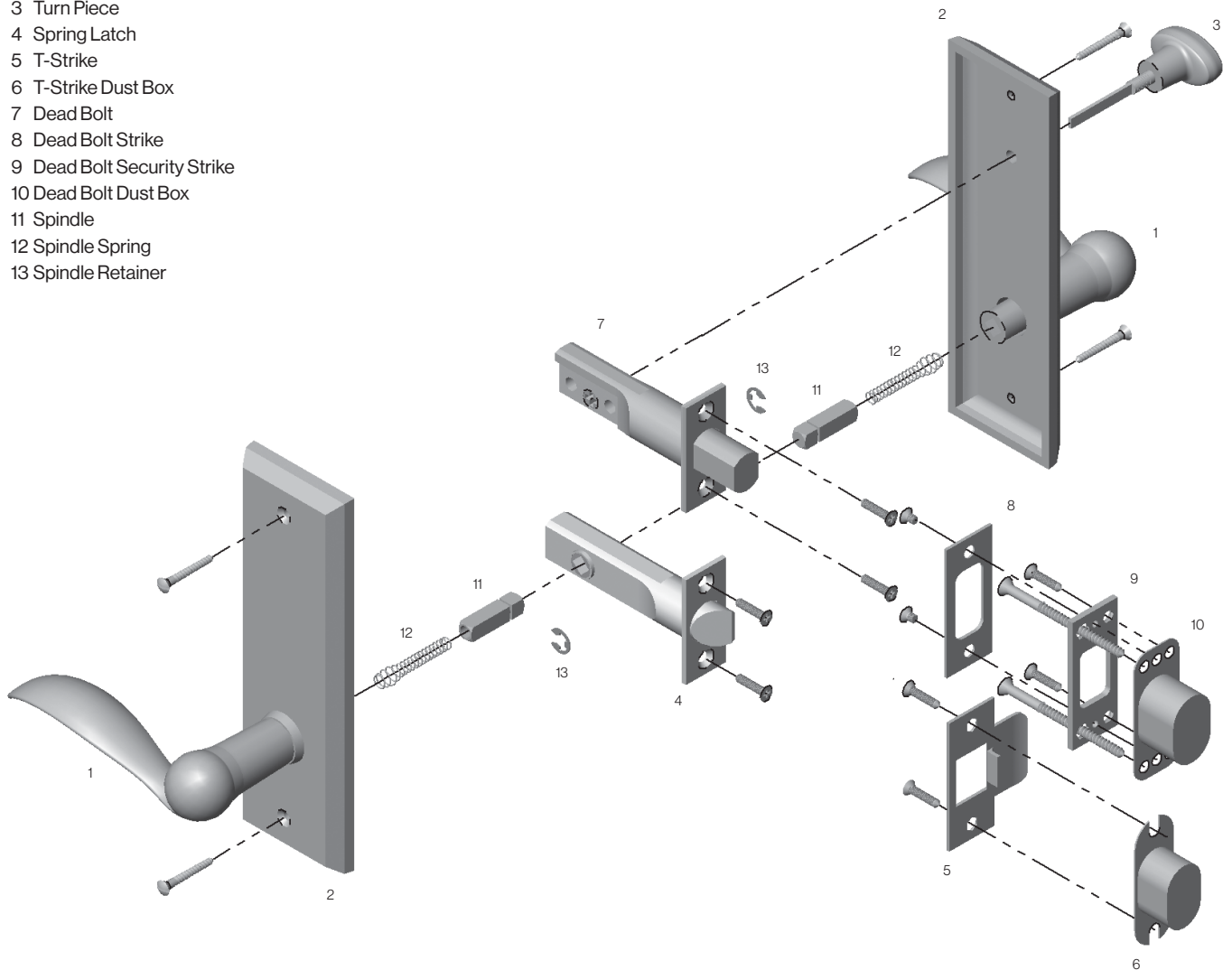

## Patio Dead Bolt Set

- 1 Escutcheon
- 2 Turn Piece
- 3 Dead Bolt
- 4 Bolt Strike
- 5 Dead Bolt Dust Box

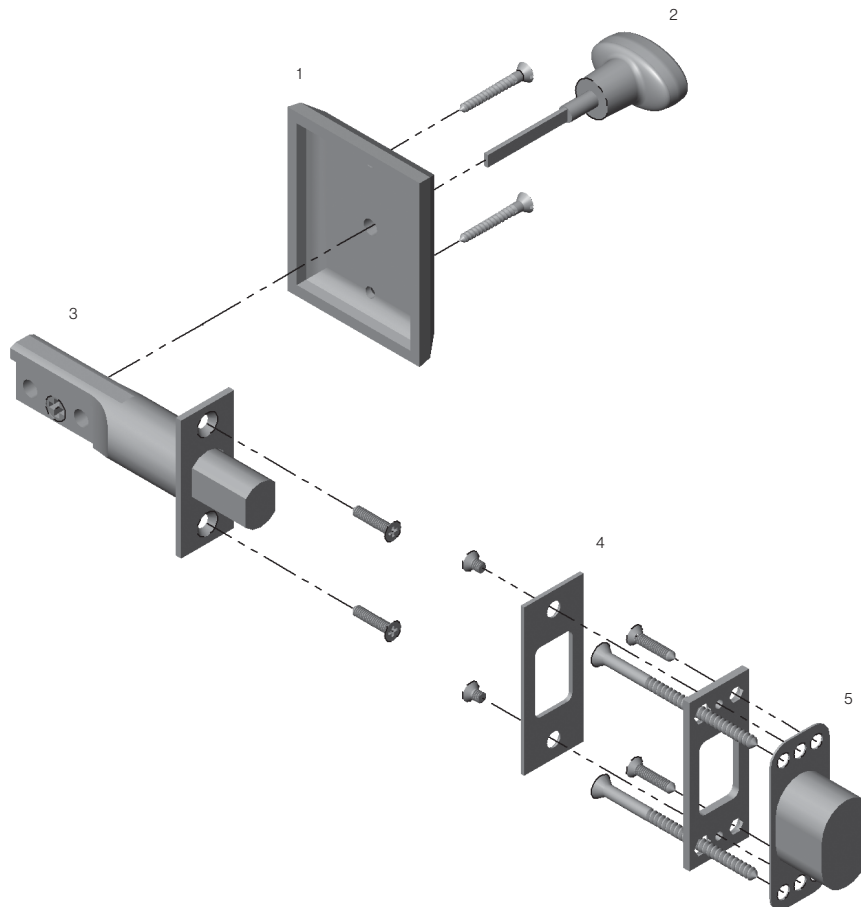





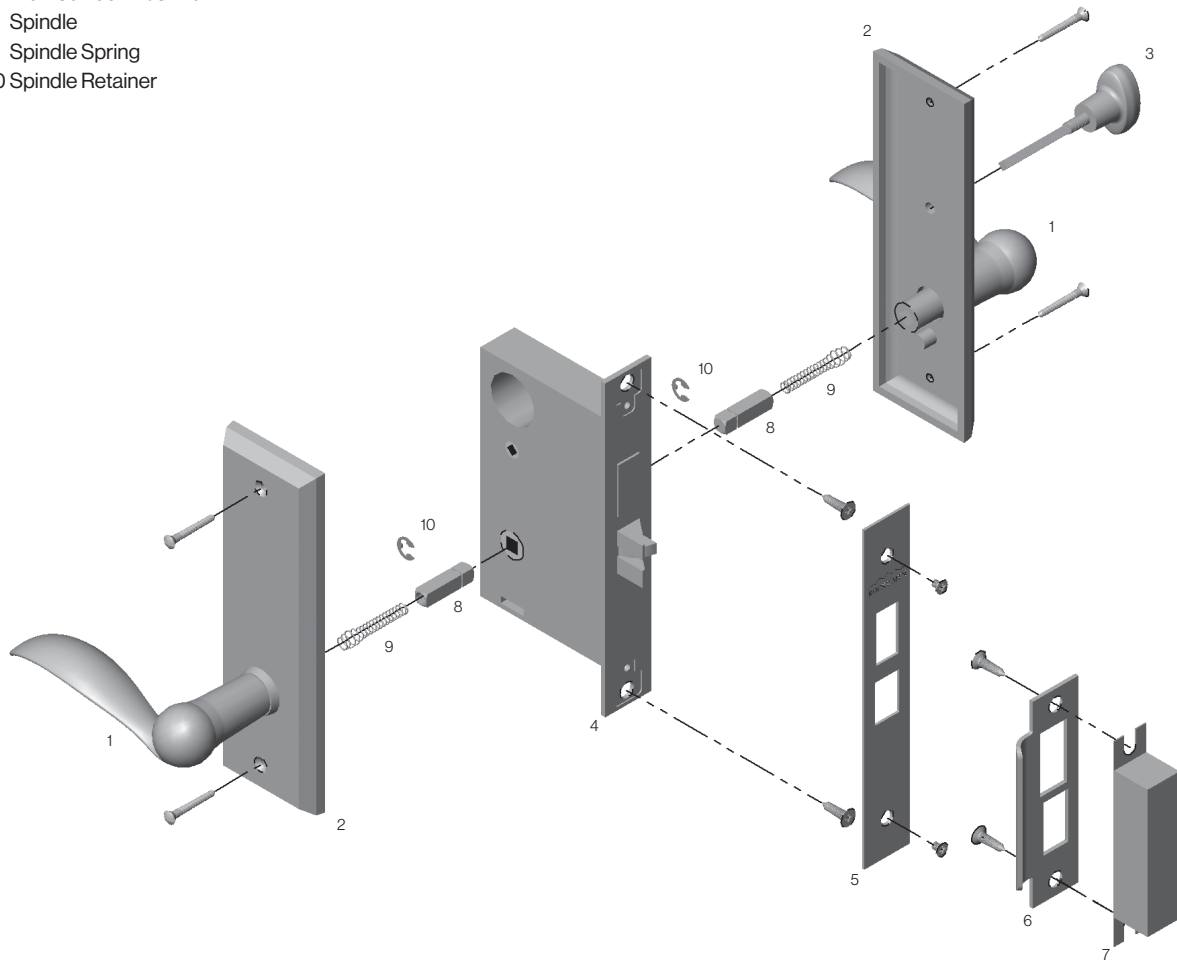



Patio Mortise Lock Set—Lever to Lever



- 1 Lever
- 2 Escutcheon
- 3 Turn Piece
- 4 Mortise Lock
- 5 Scalp
- 6 Mortise Lock Strike
- 7 Mortise Lock Dust Box
- 8 Spindle
- 9 Spindle Spring
- 10 Spindle Retainer

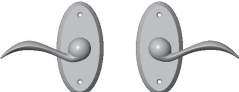
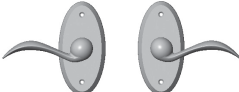
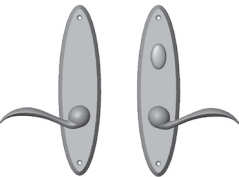
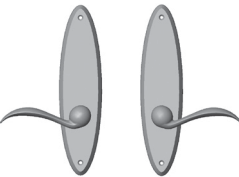

- Price includes your choice of handle except for the Crystal and Glass Knobs (K150, K151, K155, K156), where an upcharge applies. (Knobs not recommended for use with E417 and E418 escutcheons.) Call RMH for pricing.
- Combinations are shown with L105 Beaver Tail Lever for illustration purposes only. Refer to Section A for desired handle.
- Refer to website for door preparatory specifications. Call RMH to verify compatibility of each escutcheon with pre-existing door conditions.
- These escutcheons (E417 and E418) are not compatible with a 2 1/8" face bore.
- Specify metal, patina, handing, backset, door thickness, and lock type.
- Refer to Section B for Escutcheon Specifications.

	ACTIVE	DUMMY	ESCUTCHEON OPTIONS
<b>A</b>	 IP417		<b>A 2 5/8" Round Escutcheon</b> IP417 Patio Dead Bolt..... \$ 315
<b>B</b>	 IP716		<b>B 2 1/2" x 3 3/4" Arched Escutcheon</b> IP716 Patio Dead Bolt..... \$ 315
<b>C</b>	 IP417		<b>C 2 1/2" Round Escutcheon</b> E417 / E417 / IP417 Patio Dead Bolt/ Spring Latch..... \$ 908 E417 Single Dummy..... \$ 245 E417 / E417 Full Dummy ..... \$ 490
	 E417 E417	 E417 E417	<b>D 3 1/4" Round Escutcheon</b> E418 / E418 / IP417 Patio Dead Bolt/ Spring Latch..... \$ 929 E418 Single Dummy ..... \$ 259 E418 / E418 Full Dummy ..... \$ 518
<b>D</b>	 IP417		<b>E 2 5/8" x 5 1/4" Oval Escutcheon</b> E501 / E501 / IP417 Patio Dead Bolt/ Spring Latch..... \$ 935 E501 Single Dummy ..... \$ 260 E501 / E501 Full Dummy ..... \$ 520
	 E418 E418	 E418 E418	<b>F 2 1/2" x 10" Oval Escutcheon</b> E540 / E541 Patio Dead Bolt/ Spring Latch..... \$ 1,065 E540 / E541 Patio Mortise Lock ..... \$ 1,273 E540 Single Dummy..... \$ 349 E540 / E540 Full Dummy ..... \$ 698
<b>E</b>	 IP417		
	 E501 E501	 E501 E501	
<b>F</b>	 E540 E541	 E540 E540	



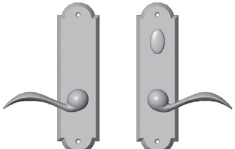
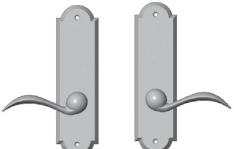
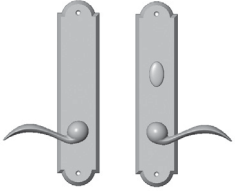
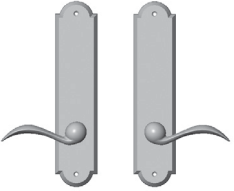
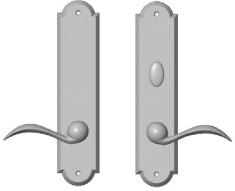
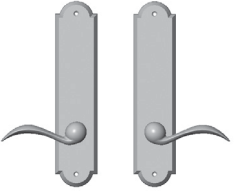



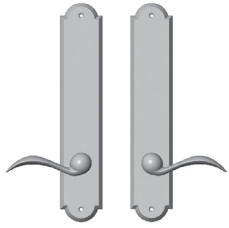
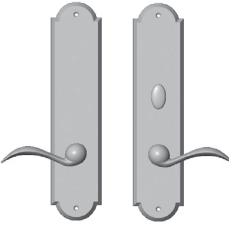
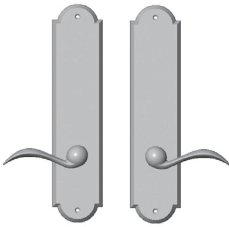



- Price includes your choice of handle except for the Crystal and Glass Knobs (K150, K151, K155, K156), where an upcharge applies. Call RMH for pricing.
- Combinations are shown with L105 Beaver Tail Lever for illustration purposes only. Refer to Section A for desired handle.
- Refer to website for door preparatory specifications. Call RMH to verify compatibility of each escutcheon with pre-existing door conditions.
- Specify metal, patina, handing, backset, door thickness, and lock type.
- Refer to Section B for Escutcheon Specifications.

	ACTIVE	DUMMY	ESCUTCHEON OPTIONS
<b>A</b>	 IP716		<b>A 2 1/2" x 5 1/2" Arched Escutcheon</b> E701 / E701 / IP716 Patio Dead Bolt/ Spring Latch..... \$ 993 E701 Single Dummy ..... \$ 290 E701 / E701 Full Dummy ..... \$ 580
	 E701 E701	 E701 E701	
<b>B</b>	 E702 E723	 E702 E702	
	 E704 E721	 E704 E704	
<b>C</b>	 E704 E721	 E704 E704	<b>C 2 1/2" x 11" Arched Escutcheon</b> E704 / E721 Patio Dead Bolt/ Spring Latch..... \$ 1,065 E704 / E721 Patio Mortise Lock ..... \$ 1,273 E704 Single Dummy ..... \$ 349 E704 / E704 Full Dummy ..... \$ 698



- Price includes your choice of handle except for the Crystal and Glass Knobs (K150, K151, K155, K156), where an upcharge applies. Call RMH for pricing.
- Combinations are shown with L105 Beaver Tail Lever for illustration purposes only. Refer to Section A for desired handle.
- Refer to website for door preparatory specifications. Call RMH to verify compatibility of each escutcheon with pre-existing door conditions.
- Specify metal, patina, handing, backset, door thickness, and lock type.
- Refer to Section B for Escutcheon Specifications.

	ACTIVE	DUMMY	ESCUTCHEON OPTIONS
<b>A</b>	 E736 E737	 E736 E736	<b>A 2 1/2" x 13" Arched Escutcheon</b> E736 / E737 Patio Dead Bolt/ Spring Latch..... \$ 1,099 E736 / E737 Patio Mortise Lock..... \$ 1,307 E736 Single Dummy..... \$ 367 E736 / E736 Full Dummy..... \$ 734
<b>B</b>	 E706 E728	 E706 E706	<b>B 3" x 13" Arched Escutcheon</b> E706 / E728 Patio Dead Bolt/ Spring Latch..... \$ 1,165 E706 / E728 Patio Mortise Lock..... \$ 1,371 E706 Single Dummy..... \$ 399 E706 / E706 Full Dummy..... \$ 798





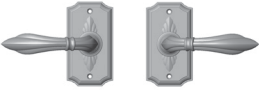
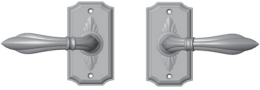

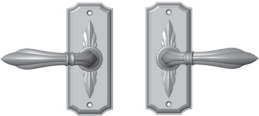
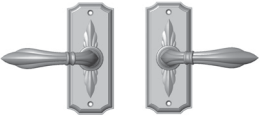
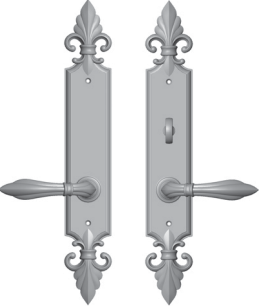
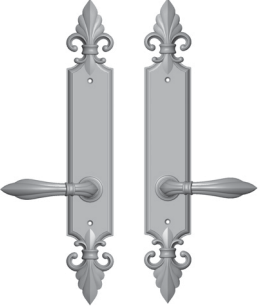

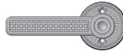

- Price includes your choice of handle except for the Crystal and Glass Knobs (K150, K151, K155, K156), where an upcharge applies. (Knobs not recommended for use with E30802 and E30803 escutcheons.) Call RMH for pricing.
- Combinations are shown with L30180 Chateau Lever for illustration purposes only. Refer to Section A for desired handle.
- Refer to website for door preparatory specifications. Call RMH to verify compatibility of each escutcheon with pre-existing door conditions.
- These escutcheons (E30802 and E30803) are not compatible with a 2 1/8" face bore.
- Specify metal, patina, handing, backset, door thickness, and lock type.
- Refer to Section B for Escutcheon Specifications.

ACTIVE	DUMMY	ESCUTCHEON OPTIONS
<p><b>A</b></p>  <p>IP30890</p>		<p><b>A 2 1/2" x 3 1/4" Bordeaux Escutcheon</b>                      IP30890 Patio Dead Bolt ..... \$ 329</p>
<p><b>B</b></p>  <p>IP30890</p>		<p><b>B 2 1/2" Round Bordeaux Escutcheon</b>                      E30802 / E30802 / IP30890 Patio Dead Bolt/                      Spring Latch..... \$ 1,225                      E30802 Single Dummy ..... \$ 381                      E30802 / E30802 Full Dummy ..... \$ 762</p>
 <p>E30802 E30802</p>	 <p>E30802 E30802</p>	
<p><b>C</b></p>  <p>IP30890</p>		<p><b>C 3 1/4" Round Bordeaux Escutcheon</b>                      E30803 / E30803 / IP30890 Patio Dead Bolt/                      Spring Latch..... \$ 1,225                      E30803 Single Dummy ..... \$ 381                      E30803 / E30803 Full Dummy ..... \$ 762</p>
 <p>E30803 E30803</p>	 <p>E30803 E30803</p>	
<p><b>D</b></p>  <p>IP30890</p>		<p><b>D 2 1/2" x 5 1/2" Oval Bordeaux Escutcheon</b>                      E30806 / E30806 / IP30890 Patio Dead Bolt/                      Spring Latch..... \$ 1,368                      E30806 Single Dummy ..... \$ 453                      E30806 / E30806 Full Dummy ..... \$ 906</p>
 <p>E30806 E30806</p>	 <p>E30806 E30806</p>	

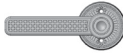
- Price includes your choice of handle except for the Crystal and Glass Knobs (K150, K151, K155, K156), where an upcharge applies. Call RMH for pricing.
- Combinations are shown with L30180 Chateau Lever for illustration purposes only. Refer to Section A for desired handle.
- Refer to website for door preparatory specifications. Call RMH to verify compatibility of each escutcheon with pre-existing door conditions.
- Specify metal, patina, handing, backset, door thickness, and lock type.
- Refer to Section B for Escutcheon Specifications.

	ACTIVE	DUMMY	ESCUTCHEON OPTIONS
<b>A</b>	 <p>IP30890</p>  <p>E30804 E30804</p>	 <p>E30804 E30804</p>	<p><b>A 2 1/2" x 4 1/2" Bordeaux Escutcheon</b>                      E30804 / E30804 / IP30890 Patio Dead Bolt/                      Spring Latch..... \$ 1,368                      E30804 Single Dummy ..... \$ 453                      E30804 / E30804 Full Dummy ..... \$ 906</p>
<b>B</b>	 <p>IP30890</p>  <p>E30805 E30805</p>	 <p>E30805 E30805</p>	<p><b>B 2 1/2" x 6" Bordeaux Escutcheon</b>                      E30805 / E30805 / IP30890 Patio Dead Bolt/                      Spring Latch..... \$ 1,368                      E30805 Single Dummy ..... \$ 453                      E30805 / E30805 Full Dummy ..... \$ 906</p>
<b>C</b>	 <p>E30810 E30811</p>	 <p>E30810 E30810</p>	<p><b>C 2 1/2" x 16 7/16" Bordeaux Escutcheon</b>                      E30810 / E30811 Patio Dead Bolt/                      Spring Latch..... \$ 1,406                      E30810 / E30811 Patio Mortise Lock ... \$ 1,612                      E30810 Single Dummy ..... \$ 512                      E30810 / E30810 Full Dummy ..... \$ 1,024</p>

- Price includes your choice of handle except for the Crystal and Glass Knobs (K150, K151, K155, K156), where an upcharge applies. (Knobs not recommended for use with E10820 escutcheon.) Call RMH for pricing.
- Combinations are shown with L10801 Briggs Lever for illustration purposes only. Refer to Section A for desired handle.
- Refer to website for door preparatory specifications. Call RMH to verify compatibility of each escutcheon with pre-existing door conditions.
- This escutcheon (E10820) is not compatible with a 2 1/8" face bore.
- Specify metal, patina, handing, backset, door thickness, and lock type.
- Refer to Section B for Escutcheon Specifications.

	ACTIVE	DUMMY	ESCUTCHEON OPTIONS
<b>A</b>	 IP10800		<b>A 2 1/2" x 5 1/8" Briggs Escutcheon</b> IP10800 Patio Dead Bolt ..... \$ 345
<b>B</b>	 IP10800   E10820 E10820	  E10820 E10820	<b>B 2 1/2" Round Briggs Escutcheon</b> E10820 / E10820 / IP10800 Patio Dead Bolt/ Spring Latch..... \$ 938 E10820 Single Dummy ..... \$ 245 E10820 / E10820 Full Dummy ..... \$ 490
<b>C</b>	 IP10800   E10800 E10800	  E10800 E10800	<b>C 2 3/8" x 7" Briggs Escutcheon</b> E10800 / E10800 / IP10800 Patio Dead Bolt/ Spring Latch..... \$ 1,010 E10800 Single Dummy ..... \$ 306 E10800 / E10800 Full Dummy..... \$ 612



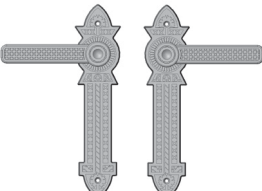
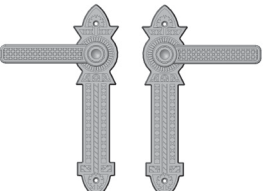
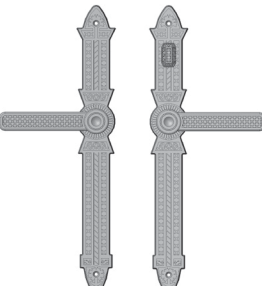
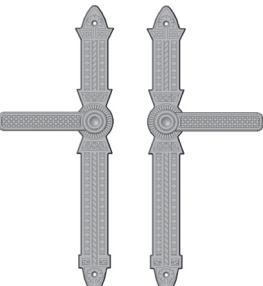
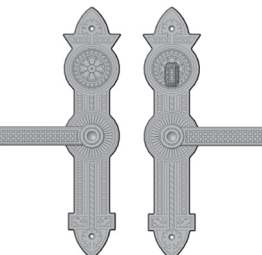
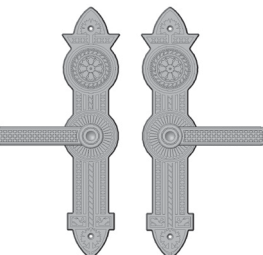

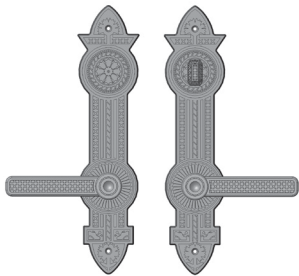
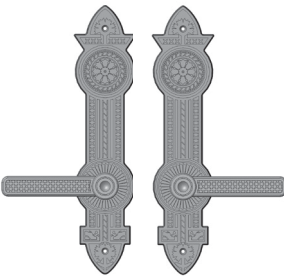

- Price includes your choice of handle except for the Crystal and Glass Knobs (K150, K151, K155, K156), where an upcharge applies. Call RMH for pricing.
- Combinations are shown with L10801 Briggs Lever for illustration purposes only. Refer to Section A for desired handle.
- Refer to website for door preparatory specifications. Call RMH to verify compatibility of each escutcheon with pre-existing door conditions.
- These escutcheons (E10871 and E10877) are not compatible with a 2 1/8" face bore.
- Specify metal, patina, handing, backset, door thickness, and lock type.
- Refer to Section B for Escutcheon Specifications.

	ACTIVE	DUMMY	ESCUTCHEON OPTIONS
<b>A</b>	 IP10800  E10810 E10810	 E10810 E10810	<b>A 2 3/8" x 10" Briggs Escutcheon</b> E10810 / E10810 / IP10800 Patio Dead Bolt/ Spring Latch. . . . . \$ 1,096 E10810 Single Dummy . . . . . \$ 349 E10810 / E10810 Full Dummy . . . . . \$ 698
<b>B</b>	 E10871 E10877	 E10871 E10871	<b>B 2" x 15" Briggs Escutcheon</b> E10871 / E10877 Patio Dead Bolt/ Spring Latch. . . . . \$ 1,065 E10871 / E10877 Patio Mortise Lock. . . \$ 1,273 E10871 Single Dummy . . . . . \$ 349 E10871 / E10871 Full Dummy. . . . . \$ 698
<b>C</b>	 E10831 E10832	 E10831 E10831	<b>C 3" x 13" Briggs Escutcheon</b> E10831 / E10832 Patio Dead Bolt/ Spring Latch. . . . . \$ 1,165 E10831 / E10832 Patio Mortise Lock . . \$ 1,371 E10831 Single Dummy . . . . . \$ 399 E10831 / E10831 Full Dummy . . . . . \$ 798





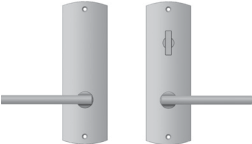
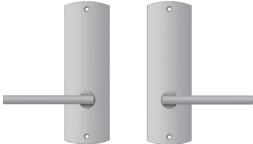

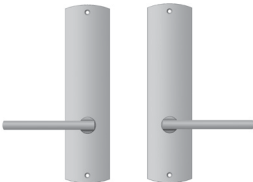
- Price includes your choice of handle except for the Crystal and Glass Knobs (K150, K151, K155, K156), where an upcharge applies. Call RMH for pricing.
- Combinations are shown with L10801 Briggs Lever for illustration purposes only. Refer to Section A for desired handle.
- Refer to website for door preparatory specifications. Call RMH to verify compatibility of each escutcheon with pre-existing door conditions.
- These escutcheons (E10871 and E10877) are not compatible with a 2 1/8" face bore.
- Specify metal, patina, handing, backset, door thickness, and lock type.
- Refer to Section B for Escutcheon Specifications.

ACTIVE	DUMMY	ESCUTCHEON OPTIONS
<p><b>A</b></p>  <p>E10834    E10835</p>	<p><b>DUMMY</b></p>  <p>E10834    E10834</p>	<p><b>A 3" x 13" Briggs Escutcheon</b></p> <p>E10834 / E10835 Patio Dead Bolt/ Spring Latch. . . . . \$ 1,165</p> <p>E10834 / E10835 Patio Mortise Lock . . . \$ 1,371</p> <p>E10834 Single Dummy . . . . . \$ 399</p> <p>E10834 / E10834 Full Dummy . . . . . \$ 798</p>



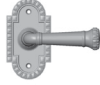

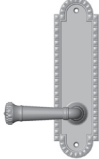

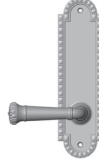
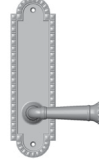



- Price includes your choice of handle except for the Crystal and Glass Knobs (K150, K151, K155, K156), where an upcharge applies. Call RMH for pricing.
- Combinations are shown with L135 Olympus Lever for illustration purposes only. Refer to Section A for desired handle.
- Refer to website for door preparatory specifications. Call RMH to verify compatibility of each escutcheon with pre-existing door conditions.
- Specify metal, patina, handing, backset, door thickness, and lock type.
- Refer to Section B for Escutcheon Specifications.

	ACTIVE	DUMMY	ESCUTCHEON OPTIONS
<b>A</b>	 IP30590		<b>A 2 1/2" x 3 1/4" Convex Escutcheon</b> IP30590 Patio Dead Bolt ..... \$ 329
<b>B</b>	 IP30590		<b>B 2 1/2" x 4 1/2" Convex Escutcheon</b> E30503 / E30503 / IP30590 Patio Dead Bolt/ Spring Latch..... \$ 1,368 E30503 Single Dummy..... \$ 453 E30503 / E30503 Full Dummy ..... \$ 906
	 E30503 E30505	 E30503 E30505	<b>C 2 1/2" x 8" Convex Escutcheon</b> E30506 / E30505 Patio Dead Bolt/ Spring Latch..... \$ 1,317 E30506 / E30505 Patio Mortise Lock \$ 1,524 E30506 Single Dummy..... \$ 467 E30506 / E30506 Full Dummy ..... \$ 934
<b>C</b>	 E30506 E30505	 E30506 E30506	<b>D 2 1/2" x 10" Convex Escutcheon</b> E30508 / E30509 Patio Dead Bolt/ Spring Latch..... \$ 1,344 E30508 / E30509 Patio Mortise Lock \$ 1,551 E30508 Single Dummy..... \$ 480 E30508 / E30508 Full Dummy ..... \$ 960
<b>D</b>	 E30508 E30509	 E30508 E30508	











- Price includes your choice of handle except for the Crystal and Glass Knobs (K150, K151, K155, K156), where an upcharge applies. Call RMH for pricing.
- Combinations are shown with L30160 Crown Lever for illustration purposes only. Refer to Section A for desired handle.
- Refer to website for door preparatory specifications. Call RMH to verify compatibility of each escutcheon with pre-existing door conditions.
- Specify metal, patina, handing, backset, door thickness, and lock type.
- Refer to Section B for Escutcheon Specifications.

	ACTIVE	DUMMY	ESCUTCHEON OPTIONS
<b>A</b>	 IP30690		<b>A 2 1/2" x 4 1/2" Corbel Arched Escutcheon</b> IP30690 Patio Dead Bolt ..... \$ 329
<b>B</b>	 IP30690    E30603 E30603	  E30603 E30603	<b>B 2 1/2" x 4 1/2" Corbel Arched Escutcheon</b> E30603 / E30603 / IP30690 Patio Dead Bolt/ Spring Latch. .... \$ 1,368 E30603 Single Dummy ..... \$ 453 E30603 / E30603 Full Dummy ..... \$ 906
<b>C</b>	  E30606 E30607	  E30606 E30606	<b>C 2 1/2" x 9" Corbel Arched Escutcheon</b> E30606 / E30607 Patio Dead Bolt/ Spring Latch. .... \$ 1,344 E30606 / E30607 Patio Mortise Lock \$ 1,551 E30606 Single Dummy ..... \$ 480 E30606 / E30606 Full Dummy ..... \$ 960



















- Price includes your choice of handle except for the Crystal and Glass Knobs (K150, K151, K155, K156), where an upcharge applies. Call RMH for pricing.
- Combinations are shown with L30160 Crown Lever for illustration purposes only. Refer to Section A for desired handle.
- Refer to website for door preparatory specifications. Call RMH to verify compatibility of each escutcheon with pre-existing door conditions.
- Specify metal, patina, handing, backset, door thickness, and lock type.
- Refer to Section B for Escutcheon Specifications.

	ACTIVE	DUMMY	ESCUTCHEON OPTIONS
<b>A</b>	 <p>IP30790</p>		<p><b>A 2 1/2" x 4" Corbel Rectangular Escutcheon</b>                      IP30790 Patio Dead Bolt ..... \$ 329</p>
<b>B</b>	 <p>IP30790</p>   <p>E30703 E30703</p>	  <p>E30703 E30703</p>	<p><b>B 2 1/2" x 4 1/2" Corbel Rectangular Escutcheon</b>                      E30703 / E30703 / IP30790 Patio Dead Bolt/                      Spring Latch. .... \$ 1,368                      E30703 Single Dummy ..... \$ 453                      E30703 / E30703 Full Dummy ..... \$ 906</p>
<b>C</b>	  <p>E30706 E30707</p>	  <p>E30706 E30706</p>	<p><b>C 2 1/2" x 9" Corbel Rectangular Escutcheon</b>                      E30706 / E30707 Patio Dead Bolt/                      Spring Latch. .... \$ 1,344                      E30706 / E30707 Patio Mortise Lock \$ 1,551                      E30706 Single Dummy ..... \$ 480                      E30706 / E30706 Full Dummy ..... \$ 960</p>







- Price includes your choice of handle except for the Crystal and Glass Knobs (K150, K151, K155, K156), where an upcharge applies. Call RMH for pricing.
- Combinations are shown with L135 Olympus Lever for illustration purposes only. Refer to Section A for desired handle.
- Refer to website for door preparatory specifications. Call RMH to verify compatibility of each escutcheon with pre-existing door conditions.
- Specify metal, patina, handing, backset, door thickness, and lock type.
- Refer to Section B for Escutcheon Specifications.

	ACTIVE	DUMMY	ESCUTCHEON OPTIONS
<b>A</b>	 IP512		<b>A 2 1/2" x 3 3/8" Curved Escutcheon</b> IP512 Patio Dead Bolt..... \$ 315
<b>B</b>	 IP512		<b>B 2 1/2" x 4 1/2" Curved Escutcheon</b> E504 / E504 / IP512 Patio Dead Bolt/ Spring Latch..... \$ 950 E504 Single Dummy..... \$ 253 E504 / E504 Full Dummy..... \$ 506
	 E504 E504	 E504 E504	<b>C 2 1/2" x 8" Curved Escutcheon</b> E508 / E506 Patio Dead Bolt/ Spring Latch..... \$ 975 E508 / E506 Patio Mortise Lock ..... \$ 1,180 E508 Single Dummy..... \$ 302 E508 / E508 Full Dummy..... \$ 604
<b>C</b>	 E508 E506	 E508 E508	<b>D 2 1/2" x 11" Curved Escutcheon</b> E512 / E513 Patio Dead Bolt/ Spring Latch..... \$ 1,065 E512 / E513 Patio Mortise Lock..... \$ 1,273 E512 Single Dummy ..... \$ 349 E512 / E512 Full Dummy ..... \$ 698
<b>D</b>	 E512 E513	 E512 E512	<b>E 2 1/2" x 13" Curved Escutcheon</b> E556 / E557 Patio Dead Bolt/ Spring Latch..... \$ 1,099 E556 / E557 Patio Mortise Lock..... \$ 1,307 E556 Single Dummy ..... \$ 367 E556 / E556 Full Dummy ..... \$ 734
<b>E</b>	 E556 E557	 E556 E556	

- Price includes your choice of handle except for the Crystal and Glass Knobs (K150, K151, K155, K156), where an upcharge applies. (Knobs not recommended for use with E101 and E103 escutcheons.) Call RMH for pricing.
- Combinations are shown with L135 Olympus Lever for illustration purposes only. Refer to Section A for desired handle.
- Refer to website for door preparatory specifications. Call RMH to verify compatibility of each escutcheon with pre-existing door conditions.
- These escutcheons (E101 and E103) are not compatible with a 2 1/8" face bore.
- Specify metal, patina, leather or texture, handing, backset, door thickness, and lock type.
- Refer to page Ei for leather and texture options. See website or brochure for details. (IP205 and IP203 do not feature leather or texture.)
- Refer to Section B for Escutcheon Specifications.

	ACTIVE	DUMMY	ESCUTCHEON OPTIONS
<b>A</b>	 IP205   E101 E101	  E101 E101	<b>A 3 1/2" Round Designer Escutcheon</b> E101 / E101 / IP205 Patio Dead Bolt/ Spring Latch..... \$ 1,602 E101 Single Dummy..... \$ 571 E101 / E101 Full Dummy..... \$ 1,142
<b>B</b>	 IP203   E103 E103	  E103 E103	<b>B 3" x 3" Square Designer Escutcheon</b> E103 / E103 / IP203 Patio Dead Bolt Spring Latch..... \$ 1,602 E103 Single Dummy..... \$ 571 E103 / E103 Full Dummy..... \$ 1,142
<b>C</b>	  E110 E112	  E110 E110	<b>C 3" x 8" Designer Escutcheon</b> E110 / E112 Patio Dead Bolt Spring Latch..... \$ 1,709 E110 / E112 Patio Mortise Lock..... \$ 1,939 E110 Single Dummy..... \$ 712 E110 / E110 Full Dummy..... \$ 1,424
<b>D</b>	  E115 E116	  E115 E115	<b>D 3" x 10" Designer Escutcheon</b> E115 / E116 Patio Dead Bolt/ Spring Latch..... \$ 1,834 E115 / E116 Patio Mortise Lock..... \$ 2,063 E115 Single Dummy..... \$ 737 E115 / E115 Full Dummy..... \$ 1,474



- Price includes your choice of handle except for the Crystal and Glass Knobs (K150, K151, K155, K156), where an upcharge applies. (Knobs are not recommended for use with E153 escutcheon) Call RMH for pricing.
- Combinations are shown with L304 Reed Lever for illustration purposes only. Refer to Section A for desired handle.
- Refer to website for door preparatory specifications. Call RMH to verify compatibility of each escutcheon with pre-existing door conditions.
- These escutcheons (E153, E160, and E162) are not compatible with a 2 1/8" face bore.
- Specify metal, style, patina, handing, backset, door thickness, and lock type.
- Requires a minimum of 1 3/4" door thickness.
- Refer to Section B for Escutcheon Specifications.

	ACTIVE	DUMMY	ESCUTCHEON OPTIONS
<b>A</b>	 IP150		<b>A 2" x 3" Edge Escutcheon</b> IP150 Patio Dead Bolt ..... \$ 315
<b>B</b>	 IP150		<b>B 2" x 3" Edge Escutcheon</b> E153 / E153 / IP150 Patio Dead Bolt/ Spring Latch. .... \$ 950 E153 Single Dummy ..... \$ 253 E153 / E153 Full Dummy ..... \$ 506
	 E153 E153	 E153 E153	<b>C 2" x 8" Edge Escutcheon</b> E160 / E162 Patio Dead Bolt/ Spring Latch. .... \$ 975 E160/ E162 Patio Mortise Lock ..... \$ 1,180 E160 Single Dummy ..... \$ 302 E160 / E160 Full Dummy ..... \$ 604
<b>C</b>	 E160 E162	 E160 E160	

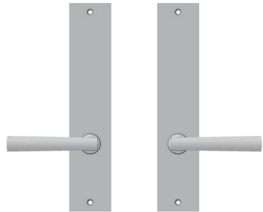
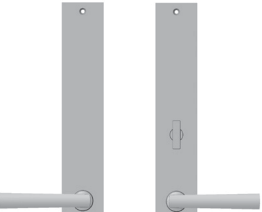
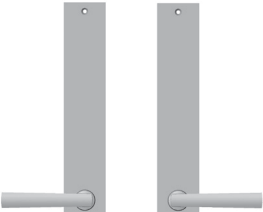
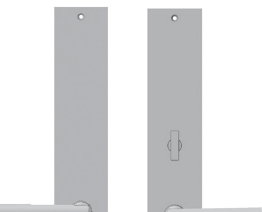
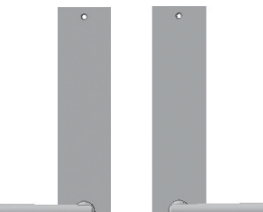

- Price includes your choice of handle except for the Crystal and Glass Knobs (K150, K151, K155, K156), where an upcharge applies. Call RMH for pricing.
- Combinations are shown with L304 Reed Lever for illustration purposes only. Refer to Section A for desired handle.
- Refer to website for door preparatory specifications. Call RMH to verify compatibility of each escutcheon with pre-existing door conditions.
- These escutcheons (E165, E166, E170, and E171) are not compatible with a 2 1/8" face bore.
- Specify metal, style, patina, handing, backset, door thickness, and lock type.
- Requires a minimum of 1 3/4" door thickness.
- Refer to Section B for Escutcheon Specifications.

	ACTIVE	DUMMY	ESCUTCHEON OPTIONS
<b>A</b>	 <p>E165 E166</p>	 <p>E165 E165</p>	<p><b>A 2" x 10" Edge Escutcheon</b></p> <p>E165 / E166 Patio Dead Bolt/ Spring Latch..... \$ 1,065</p> <p>E165 / E166 Patio Mortise Lock..... \$ 1,273</p> <p>E165 Single Dummy ..... \$ 349</p> <p>E165 / E165 Full Dummy ..... \$ 698</p>
<b>B</b>	 <p>E170 E171</p>	 <p>E170 E170</p>	<p><b>B 2" x 13" Edge Escutcheon</b></p> <p>E170 / E171 Patio Dead Bolt/ Spring Latch..... \$ 1,099</p> <p>E170 / E171 Patio Mortise Lock ..... \$ 1,307</p> <p>E170 Single Dummy ..... \$ 367</p> <p>E170 / E170 Full Dummy ..... \$ 734</p>
<b>C</b>	 <p>E140 E141</p>	 <p>E140 E140</p>	<p><b>C 2 1/2" x 13" Edge Escutcheon</b></p> <p>E140 / E141 Patio Dead Bolt/ Spring Latch..... \$ 1,099</p> <p>E140 / E141 Patio Mortise Lock ..... \$ 1,307</p> <p>E140 Single Dummy ..... \$ 367</p> <p>E140 / E140 Full Dummy..... \$ 734</p> <p>Refer to spec page B115</p>

- Price includes your choice of handle except for the Crystal and Glass Knobs (K150, K151, K155, K156), where an upcharge applies. Call RMH for pricing. Rings are not recommended for Element Collection.
- Combinations are shown with L135 Olympus Lever for illustration purposes only. Refer to Section A for desired handle.
- Refer to website for door preparatory specifications.
- Max door thickness of 3" is applicable with lock centered, call for pricing when lock is offset.
- Minimum door thickness of 1 3/4" is applicable.
- This escutcheon (E10101) is not compatible with a 2 1/8" face bore.
- Specify metal, patina, handing, backset, door thickness, and lock type.
- Specify if double door application with active Dummy panels. Refer to door preparatory specifications for additional information.
- Refer to Section B for Escutcheon Specifications.

	ACTIVE	DUMMY	ESCUTCHEON OPTIONS
<b>A</b>	 IP10101		<b>A Element Escutcheon</b> IP10101 Patio Mortise Dead Lock . . . . . \$ 723  Supplied with Accurate 9500 Series Dead Lock.
<b>B</b>	 IP10101 E10101 E10101	 E10101 E10101	<b>B 1 1/8" Round Element Escutcheon</b> E10101 / E10101 / IP10101 Patio Mortise Lock . . . . . \$ 1,273 E10101 Single Dummy . . . . . \$ 495 E10101 / E10101 Full Dummy . . . . . \$ 843



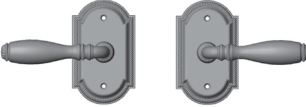
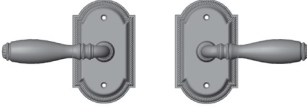
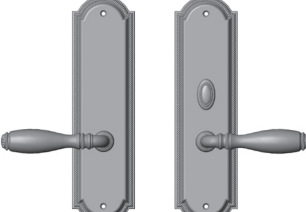
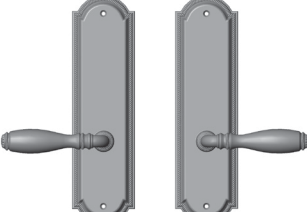
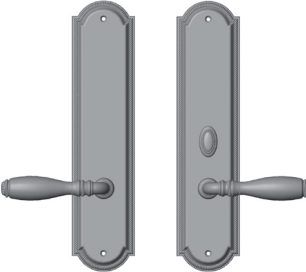
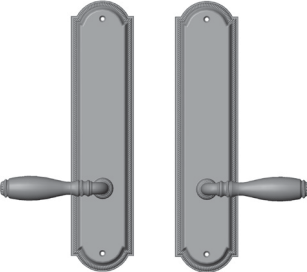

- Price includes your choice of handle except for the Crystal and Glass Knobs (K150, K151, K155, K156), where an upcharge applies. Call RMH for pricing.
- Combinations are shown with L075 Ellis Lever for illustration purposes only. Refer to Section A for desired handle.
- Refer to website for door preparatory specifications. Call RMH to verify compatibility of each escutcheon with pre-existing door conditions.
- Specify metal, patina, handing, backset, door thickness, and lock type.
- Refer to Section B for Escutcheon Specifications.

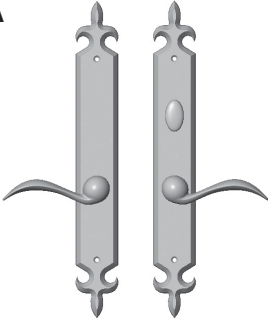
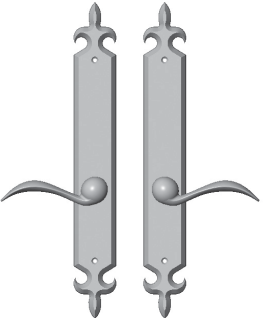
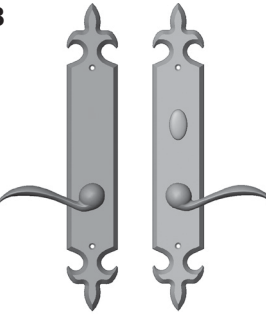
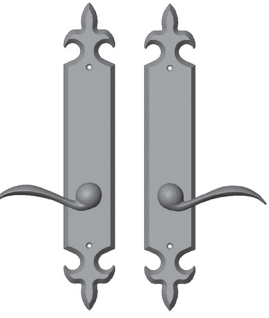
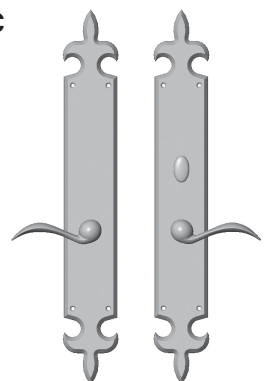
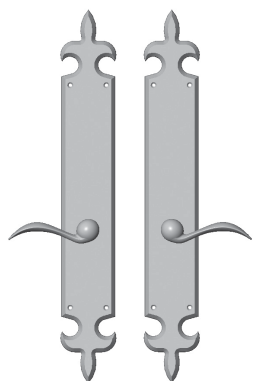
	ACTIVE	DUMMY	ESCUTCHEON OPTIONS
<b>A</b>	 IP014		<b>A 3" x 3 3/4" Ellis Escutcheon</b> IP014 Patio Dead Bolt ..... \$ 329
<b>B</b>	 IP014		<b>B 3" x 5" Ellis Escutcheon</b> E005 / E005 / IP014 Patio Dead Bolt/ Spring Latch..... \$ 1,368 E005 Single Dummy..... \$ 453 E005 / E005 Full Dummy..... \$ 906
	 E005 E005	 E005 E005	<b>C 3" x 11" Ellis Escutcheon</b> E056 / E057 Patio Dead Bolt/ Spring Latch..... \$ 1,344 E056 / E057 Patio Mortise Lock..... \$ 1,551 E056 Single Dummy..... \$ 480 E056 / E056 Full Dummy..... \$ 960
<b>C</b>	 E056 E057	 E056 E056	<b>D 3" x 13" Ellis Escutcheon</b> E060 / E063 Patio Dead Bolt/ Spring Latch..... \$ 1,406 E060 / E063 Patio Mortise Lock ..... \$ 1,612 E060 Single Dummy..... \$ 512 E060 / E060 Full Dummy ..... \$ 1,024
<b>D</b>	 E060 E063	 E060 E060	



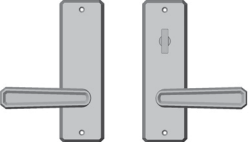
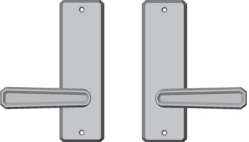
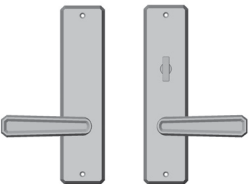
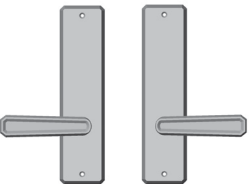

- Price includes your choice of handle except for the Crystal and Glass Knobs (K150, K151, K155, K156), where an upcharge applies. Call RMH for pricing.
- Combinations are shown with L105 Beaver Tail Lever for illustration purposes only. Refer to Section A for desired handle.
- Refer to website for door preparatory specifications. Call RMH to verify compatibility of each escutcheon with pre-existing door conditions.
- These escutcheons (E820 and E821) are not compatible with a 2 1/8" face bore.
- Specify metal, patina, handing, backset, door thickness, and lock type.
- Refer to Section B for Escutcheon Specifications.

	ACTIVE	DUMMY	ESCUTCHEON OPTIONS
<b>A</b>	 <p>E820 E821</p>	 <p>E820 E820</p>	<p><b>A 2" x 15" Fleur De Lis Escutcheon</b>                      E820 / E821 Patio Dead Bolt/                      Spring Latch..... \$ 1,065                      E820 / E821 Patio Mortise Lock ..... \$ 1,273                      E820 Single Dummy..... \$ 349                      E820 / E820 Full Dummy..... \$ 698</p>
<b>B</b>	 <p>E841 E842</p>	 <p>E841 E841</p>	<p><b>B 2 1/2" x 15" Fleur De Lis Escutcheon</b>                      E841 / E842 Patio Dead Bolt/                      Spring Latch..... \$ 1,099                      E841 / E842 Patio Mortise Lock ..... \$ 1,307                      E841 Single Dummy ..... \$ 367                      E841 / E841 Full Dummy ..... \$ 734</p>
<b>C</b>	 <p>E832 E831</p>	 <p>E832 E832</p>	<p><b>C 3" x 21" Fleur De Lis Escutcheon</b>                      E832 / E831 Patio Dead Bolt/                      Spring Latch..... \$ 1,367                      E832 / E831 Patio Mortise Lock ..... \$ 1,573                      E832 Single Dummy..... \$ 500                      E832 / E832 Full Dummy ..... \$ 1,000</p>

- Price includes your choice of handle except for the Crystal and Glass Knobs (K150, K151, K155, K156), where an upcharge applies. Call RMH for pricing.
- Combinations are shown with L30140 Smith Lever for illustration purposes only. Refer to Section A for desired handle.
- Refer to website for door preparatory specifications. Call RMH to verify compatibility of each escutcheon with pre-existing door conditions.
- Specify metal, patina, handing, backset, door thickness, and lock type.
- Refer to Section B for Escutcheon Specifications.

	ACTIVE	DUMMY	ESCUTCHEON OPTIONS
<b>A</b>	 IP30490		<b>A 2 1/2" x 3 1/4" Hammered Escutcheon</b> IP30490 Patio Dead Bolt ..... \$ 315
<b>B</b>	 IP30490		<b>B 2 1/2" x 4 1/2" Hammered Escutcheon</b> E30403 / E30403 / IP30490 Patio Dead Bolt/ Spring Latch. .... \$ 950 E30403 Single Dummy ..... \$ 253 E30403 / E30403 Full Dummy ..... \$ 506
	 E30403 E30403	 E30403 E30403	<b>C 2 1/2" x 8" Hammered Escutcheon</b> E30406 / E30407 Patio Dead Bolt/ Spring Latch. .... \$ 975 E30406 / E30407 Patio Mortise Lock \$ 1,180 E30406 Single Dummy ..... \$ 302 E30406 / E30406 Full Dummy ..... \$ 604
<b>C</b>	 E30406 E30407	 E30406 E30406	<b>D 2 1/2" x 10" Hammered Escutcheon</b> E30410 / E30411 Patio Dead Bolt/ Spring Latch. .... \$ 1,065 E30410 / E30411 Patio Mortise Lock \$ 1,273 E30410 Single Dummy ..... \$ 349 E30410 / E30410 Full Dummy ..... \$ 698
<b>D</b>	 E30410 E30411	 E30410 E30410	

- Price includes your choice of handle except for the Crystal and Glass Knobs (K150, K151, K155, K156), where an upcharge applies. Call RMH for pricing.
- Combinations are shown with L21005 Emile Lever for illustration purposes only. Refer to Section A for desired handle.
- Refer to website for door preparatory specifications. Call RMH to verify compatibility of each escutcheon with pre-existing door conditions.
- Specify metal, patina, handing, backset, door thickness, and lock type.
- Refer to Section B for Escutcheon Specifications.

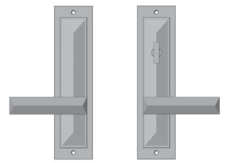
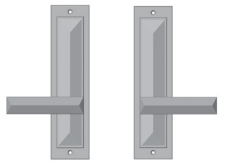
	ACTIVE	DUMMY	ESCUTCHEON OPTIONS
<b>A</b>	 IP21014		<b>A 2 1/2" x 3 1/2" Mack Escutcheon</b> IP21014 Patio Dead Bolt ..... \$ 315
<b>B</b>	 IP21014		<b>B 2 1/2" x 4 1/2" Mack Escutcheon</b> E21005 / E21005 / IP21014 Patio Dead Bolt/ Spring Latch ..... \$ 950 E21005 Single Dummy ..... \$ 253 E21005 / E21005 Full Dummy ..... \$ 506
	 E21005 E21005	 E21005 E21005	
<b>C</b>	 E21056 E21057	 E21056 E21056	<b>C 2 1/2" x 10" Mack Escutcheon</b> E21056 / E21057 Patio Dead Bolt/ Spring Latch. .... \$ 1,065 E21056 / E21057 Patio Mortise Lock. .... \$ 1,273 E21056 Single Dummy. .... \$ 349 E21056 / E21056 Full Dummy ..... \$ 698

- Price includes your choice of handle except for the Crystal and Glass Knobs (K150, K151, K155, K156), where an upcharge applies. Call RMH for pricing.
- Combinations are shown with L21005 Emile Lever for illustration purposes only. Refer to Section A for desired handle.
- Refer to website for door preparatory specifications. Call RMH to verify compatibility of each escutcheon with pre-existing door conditions.
- Specify metal, patina, handing, backset, door thickness, and lock type.
- These escutcheons (E21060 and E21063) require a backset that is 2 1/2" or greater.
- Refer to Section B for Escutcheon Specifications.

ACTIVE

DUMMY

ESCUTCHEON OPTIONS

A

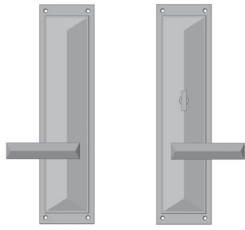

E21060 E21063

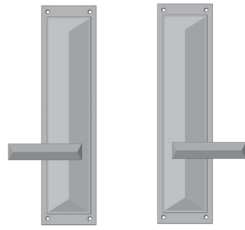





E21060 E21060

A 3 3/4" x 15" Mack Escutcheon

E21060 / E21063 Patio Dead Bolt/ Spring Latch .....	\$ 1,367
E21060 / E21063 Patio Mortise Lock.....	\$ 1,573
E21060 Single Dummy .....	\$ 500
E21060 / E21060 Full Dummy.....	\$ 1,000



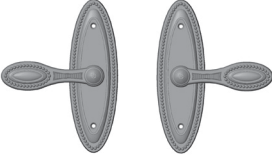
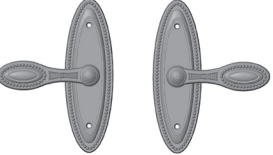

- Price includes your choice of handle except for the Crystal and Glass Knobs (K150, K151, K155, K156), where an upcharge applies. (Knobs not recommended for use with E589 escutcheon.) Call RMH for pricing.
- Combinations are shown with L580 Maddox Lever for illustration purposes only. Refer to Section A for desired handle.
- Refer to website for door preparatory specifications. Call RMH to verify compatibility of each escutcheon with pre-existing door conditions.
- This escutcheon (E589) is not compatible with a 2 1/8" face bore.
- Specify metal, patina, handing, backset, door thickness, and lock type.
- Refer to Section B for Escutcheon Specifications.

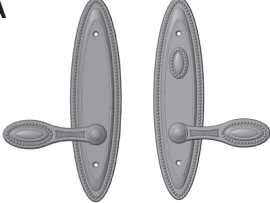
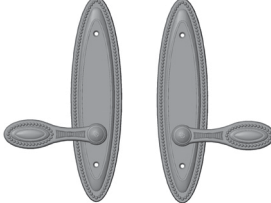
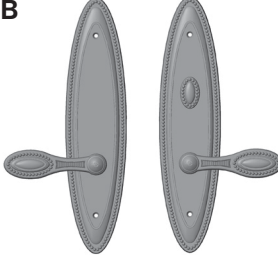
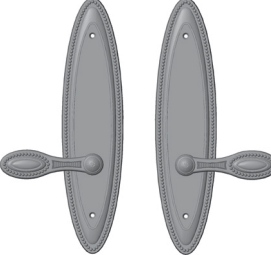
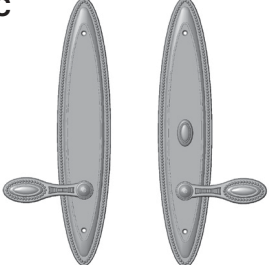
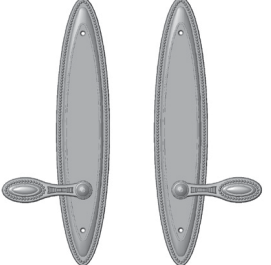
	ACTIVE	DUMMY	ESCUTCHEON OPTIONS
<b>A</b>	 IP580		<b>A 2 3/8" x 3 5/16" Maddox Escutcheon</b> IP580 Patio Dead Bolt ..... \$ 329
<b>B</b>	 IP580		<b>B 3 1/8" Round Maddox Escutcheon</b> E589 / E589 / IP580 Patio Dead Bolt/ Spring Latch..... \$ 1,225 E589 Single Dummy..... \$ 381 E589 / E589 Full Dummy ..... \$ 762
	 E589 E589	 E589 E589	<b>C 2 3/8" x 7 1/2" Maddox Escutcheon</b> E588 / E588 / IP580 Patio Dead Bolt/ Spring Latch..... \$ 1,368 E588 Single Dummy..... \$ 453 E588 / E588 Full Dummy ..... \$ 906
<b>C</b>	 IP580		
	 E588 E588	 E588 E588	







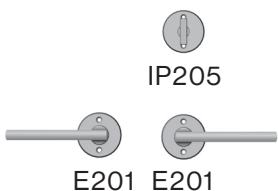

- Price includes your choice of handle except for the Crystal and Glass Knobs (K150, K151, K155, K156), where an upcharge applies. Call RMH for pricing.
- Combinations are shown with L580 Maddox Lever for illustration purposes only. Refer to Section A for desired handle.
- Refer to website for door preparatory specifications. Call RMH to verify compatibility of each escutcheon with pre-existing door conditions.
- Specify metal, patina, handing, backset, door thickness, and lock type.
- Refer to Section B for Escutcheon Specifications.

	ACTIVE	DUMMY	ESCUTCHEON OPTIONS
<b>A</b>	 E585 E587	 E585 E585	<b>A 2 1/2" x 10" Maddox Escutcheon</b> E585 / E587 Patio Dead Bolt/ Spring Latch..... \$ 1,344 E585 / E587 Patio Mortise Lock..... \$ 1,551 E585 Single Dummy..... \$ 480 E585 / E585 Full Dummy..... \$ 960
<b>B</b>	 E584 E582	 E584 E584	<b>B 3" x 12 1/2" Maddox Escutcheon</b> E584 / E582 Patio Dead Bolt/ Spring Latch..... \$ 1,406 E584 / E582 Patio Mortise Lock..... \$ 1,612 E584 Single Dummy..... \$ 512 E584 / E584 Full Dummy..... \$ 1,024
<b>C</b>	 E570 E571	 E570 E570	<b>C 3" x 15" Maddox Escutcheon</b> E570 / E571 Patio Dead Bolt/ Spring Latch..... \$ 1,538 E570 / E571 Patio Mortise Lock..... \$ 1,744 E570 Single Dummy..... \$ 578 E570 / E570 Full Dummy..... \$ 1,156

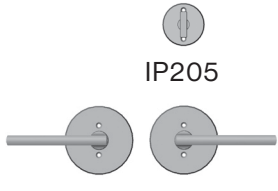
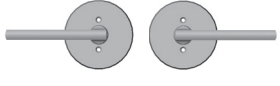
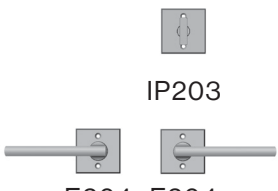
- Price includes your choice of handle except for the Crystal and Glass Knobs (K150, K151, K155, K156), where an upcharge applies. Call RMH for pricing.
- Combinations are shown with L135 Olympus Lever for illustration purposes only. Refer to Section A for desired handle.
- Refer to website for door preparatory specifications. Call RMH to verify compatibility of each escutcheon with pre-existing door conditions.
- Specify metal, patina, handing, backset, door thickness, and lock type.
- Refer to Section B for Escutcheon Specifications.

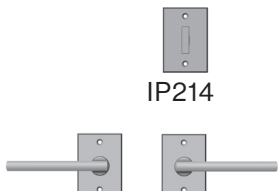
	ACTIVE	DUMMY	ESCUTCHEON OPTIONS
A	 IP205		<b>A 2 1/4" Round Metro Escutcheon</b> IP205 Patio Dead Bolt ..... \$ 315
B	 IP203		<b>B 2 1/4" Square Metro Escutcheon</b> IP203 Patio Dead Bolt ..... \$ 315
C	 IP214		<b>C 2 1/4" x 3 1/4" Metro Escutcheon</b> IP214 Patio Dead Bolt ..... \$ 315
D	 IP250		<b>D 2 1/2" x 3 1/4" Metro Escutcheon</b> IP250 Patio Dead Bolt ..... \$ 315

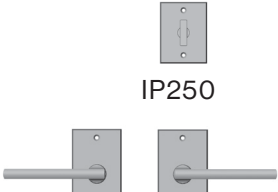

- Price includes your choice of handle except for the Crystal and Glass Knobs (K150, K151, K155, K156), where an upcharge applies. (Knobs not recommended for use with E201, E202, E204, and E205 escutcheons.) Call RMH for pricing.
- Combinations are shown with L135 Olympus Lever for illustration purposes only. Refer to Section A for desired handle.
- Refer to website for door preparatory specifications. Call RMH to verify compatibility of each escutcheon with pre-existing door conditions.
- These escutcheons (E201, E202, E204 and E205) are not compatible with a 2 1/8" face bore.
- Specify metal, patina, handing, backset, door thickness, and lock type.
- Refer to Section B for Escutcheon Specifications.

	ACTIVE	DUMMY	ESCUTCHEON OPTIONS
<b>A</b>	 <p>IP205 E201 E201</p>	 <p>E201 E201</p>	<p><b>A 2 1/4" Round Metro Escutcheon</b>                      E201 / E201 / IP205 Patio Dead Bolt/                      Spring Latch. . . . . \$ 908                      E201 Single Dummy . . . . . \$ 245                      E201 / E201 Full Dummy . . . . . \$ 490</p>
<b>B</b>	 <p>IP205 E202 E202</p>	 <p>E202 E202</p>	<p><b>B 3 1/2" Round Metro Escutcheon</b>                      E202 / E202 / IP205 Patio Dead Bolt/                      Spring Latch. . . . . \$ 971                      E202 Single Dummy. . . . . \$ 274                      E202 / E202 Full Dummy . . . . . \$ 548</p>
<b>C</b>	 <p>IP203 E204 E204</p>	 <p>E204 E204</p>	<p><b>C 2 1/4" x 2 1/4" Square Metro Escutcheon</b>                      E204 / E204 / IP203 Patio Dead Bolt/                      Spring Latch. . . . . \$ 912                      E204 Single Dummy. . . . . \$ 246                      E204 / E204 Full Dummy . . . . . \$ 492</p>
<b>D</b>	 <p>IP214 E205 E205</p>	 <p>E205 E205</p>	<p><b>D 2 1/4" x 3 1/4" Metro Escutcheon</b>                      E205 / E205 / IP214 Patio Dead Bolt/                      Spring Latch. . . . . \$ 950                      E205 Single Dummy. . . . . \$ 253                      E205 / E205 Full Dummy . . . . . \$ 506</p>
<b>E</b>	 <p>IP250 E236 E236</p>	 <p>E236 E236</p>	<p><b>E 2 1/2" x 4 1/2" Metro Escutcheon</b>                      E236 / E236 / IP250 Patio Dead Bolt/                      Spring Latch. . . . . \$ 950                      E236 Single Dummy . . . . . \$ 253                      E236 / E236 Full Dummy . . . . . \$ 506</p>



















- Price includes your choice of handle except for the Crystal and Glass Knobs (K150, K151, K155, K156), where an upcharge applies. Call RMH for pricing.
- Combinations are shown with L135 Olympus Lever for illustration purposes only. Refer to Section A for desired handle.
- Refer to website for door preparatory specifications. Call RMH to verify compatibility of each escutcheon with pre-existing door conditions.
- These escutcheons (E206, E207, E210, and E211) are not compatible with a 2 1/8" face bore.
- Specify metal, patina, handing, backset, door thickness, and lock type.
- Refer to Section B for Escutcheon Specifications.

	ACTIVE	DUMMY	ESCUTCHEON OPTIONS
<b>A</b>	<p>E210 E211</p>	<p>E210 E210</p>	<p><b>A 2 1/4" x 8" Metro Escutcheon</b></p> <p>E210 / E211 Patio Dead Bolt/ Spring Latch. . . . . \$ 975</p> <p>E210 / E211 Patio Mortise Lock . . . . . \$ 1,180</p> <p>E210 Single Dummy . . . . . \$ 302</p> <p>E210 / E210 Full Dummy . . . . . \$ 604</p>
<b>B</b>	<p>E206 E207</p>	<p>E206 E206</p>	<p><b>B 2 1/4" x 10" Metro Escutcheon</b></p> <p>E206 / E207 Patio Dead Bolt/ Spring Latch. . . . . \$ 1,065</p> <p>E206 / E207 Patio Mortise Lock . . . . . \$ 1,273</p> <p>E206 Single Dummy . . . . . \$ 349</p> <p>E206 / E206 Full Dummy . . . . . \$ 698</p>
<b>C</b>	<p>E256 E257</p>	<p>E256 E256</p>	<p><b>C 2 1/2" x 13" Metro Escutcheon</b></p> <p>E256 / E257 Patio Dead Bolt/ Spring Latch. . . . . \$ 1,099</p> <p>E256 / E257 Patio Mortise Lock . . . . . \$ 1,307</p> <p>E256 Single Dummy . . . . . \$ 367</p> <p>E256 / E256 Full Dummy . . . . . \$ 734</p>
<b>D</b>	<p>E264 E262</p>	<p>E264 E264</p>	<p><b>D 3 1/2" x 13" Metro Escutcheon</b></p> <p>E264 / E262 Patio Dead Bolt/ Spring Latch. . . . . \$ 1,165</p> <p>E264 / E262 Patio Mortise Lock . . . . . \$ 1,371</p> <p>E264 Single Dummy . . . . . \$ 399</p> <p>E264 / E264 Full Dummy . . . . . \$ 798</p>

- Refer to website for door preparatory specifications. Call RMH to verify compatibility of each escutcheon with pre-existing door conditions.
- Specify metal, patina, handing, backset, door thickness, and lock type.
- Refer to Section B for Escutcheon Specifications.

	ACTIVE	DUMMY	ESCUTCHEON OPTIONS
<b>A</b>	 IP10150		<b>A 2 9/16" x 3 7/16" Oasis Escutcheon</b> IP10150 Patio Dead Bolt ..... \$ 315
<b>B</b>	 IP10200		<b>B 2 1/2" x 3 1/4" Oasis Escutcheon</b> IP10200 Patio Dead Bolt ..... \$ 315

- Price includes your choice of handle except for the Crystal and Glass Knobs (K150, K151, K155, K156), where an upcharge applies. (Knobs not recommended for use with E10203 escutcheon.) Call RMH for pricing.
- Combinations are shown with L10302 Raleigh Lever for illustration purposes only. Refer to Section A for desired handle.
- Refer to website for door preparatory specifications. Call RMH to verify compatibility of each escutcheon with pre-existing door conditions.
- These escutcheons (E10203) are not compatible with a 2 1/8" face bore.
- Specify metal, patina, handing, backset, door thickness, and lock type.
- Refer to Section B for Escutcheon Specifications.

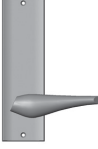
	ACTIVE	DUMMY	ESCUTCHEON OPTIONS
<b>A</b>	 IP10150   E10155 E10155	  E10155 E10155	<b>A 3" x 4 1/4" Oasis Escutcheon</b> E10155 / E10155 / IP10150 Patio Dead Bolt/ Spring Latch. . . . . \$ 950 E10155 Single Dummy . . . . . \$ 253 E10155 / E10155 Full Dummy . . . . . \$ 506
<b>B</b>	 IP10200   E10203 E10203	  E10203 E10203	<b>B 2 1/2" x 2 1/2" Square Oasis Escutcheon</b> E10203 / E10203 / IP10200 Patio Dead Bolt/ Spring Latch. . . . . \$ 912 E10203 Single Dummy . . . . . \$ 246 E10203 / E10203 Full Dummy . . . . . \$ 492
<b>C</b>	 IP10200   E10205 E10205	  E10205 E10205	<b>C 2 1/2" x 4 1/2" Oasis Escutcheon</b> E10205 / E10205 / IP10200 Patio Dead Bolt/ Spring Latch. . . . . \$ 950 E10205 Single Dummy . . . . . \$ 253 E10205 / E10205 Full Dummy . . . . . \$ 506
<b>D</b>	  E10208 E10209	  E10208 E10208	<b>D 2 1/2" x 8 1/2" Oasis Escutcheon</b> E10208 / E10209 Patio Dead Bolt/ Spring Latch. . . . . \$ 975 E10208 / E10209 Patio Mortise Lock. . . . . \$ 1,180 E10208 Single Dummy . . . . . \$ 302 E10208 / E10208 Full Dummy . . . . . \$ 604

- Price includes your choice of handle except for the Crystal and Glass Knobs (K150, K151, K155, K156), where an upcharge applies. (Knobs not recommended for use with E10203 escutcheon.) Call RMH for pricing.
- Combinations are shown with L10302 Raleigh Lever for illustration purposes only. Refer to Section A for desired handle.
- Refer to website for door preparatory specifications. Call RMH to verify compatibility of each escutcheon with pre-existing door conditions.
- Specify metal, patina, handing, backset, door thickness, and lock type.
- Refer to Section B for Escutcheon Specifications.

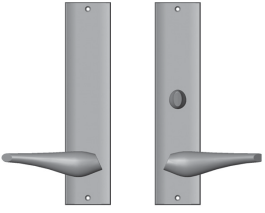
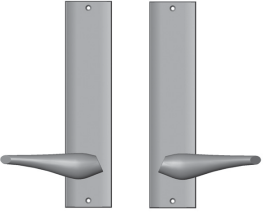
ACTIVE	DUMMY	ESCUTCHEON OPTIONS								
<p><b>A</b></p>  <p style="text-align: center;">E10216   E10217</p>	 <p style="text-align: center;">E10216   E10216</p>	<p><b>A 2 1/2" x 11" Oasis Escutcheon</b></p> <table border="0" style="width: 100%;"> <tr> <td>E10216 / E10217 Patio Dead Bolt/ Spring Latch. ....</td> <td style="text-align: right; vertical-align: bottom;">\$ 1,065</td> </tr> <tr> <td>E10216 / E10217 Patio Mortise Lock .....</td> <td style="text-align: right; vertical-align: bottom;">\$ 1,273</td> </tr> <tr> <td>E10216 Single Dummy .....</td> <td style="text-align: right; vertical-align: bottom;">\$ 349</td> </tr> <tr> <td>E10216 / E10216 Full Dummy .....</td> <td style="text-align: right; vertical-align: bottom;">\$ 698</td> </tr> </table>	E10216 / E10217 Patio Dead Bolt/ Spring Latch. ....	\$ 1,065	E10216 / E10217 Patio Mortise Lock .....	\$ 1,273	E10216 Single Dummy .....	\$ 349	E10216 / E10216 Full Dummy .....	\$ 698
E10216 / E10217 Patio Dead Bolt/ Spring Latch. ....	\$ 1,065									
E10216 / E10217 Patio Mortise Lock .....	\$ 1,273									
E10216 Single Dummy .....	\$ 349									
E10216 / E10216 Full Dummy .....	\$ 698									

- Price includes your choice of handle except for the Crystal and Glass Knobs (K150, K151, K155, K156), where an upcharge applies. Call RMH for pricing.
- Combinations are shown with L10010 Paris Lever for illustration purposes only. Refer to Section A for desired handle.
- Refer to website for door preparatory specifications. Call RMH to verify compatibility of each escutcheon with pre-existing door conditions.
- These escutcheons (E10015 and E10016) are not compatible with a 2 1/8" face bore.
- Specify metal, patina, handing, backset, door thickness, and lock type.
- Refer to Section B for Escutcheon Specifications.

ACTIVE

DUMMY

ESCUTCHEON OPTIONS

A

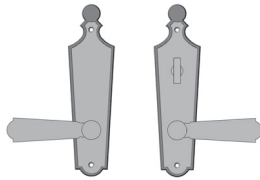

E10015 E10016

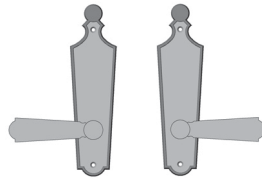





















E10015 E10015

A 2 1/2" x 9 1/4" Paris Escutcheon  
Roger Thomas Collection

E10015 / E10016 Patio Dead Bolt/ Spring Latch.....	\$ 1,168
E10015 / E10016 Patio Mortise Lock .....	\$ 1,395
E10015 Single Dummy .....	\$ 384
E10015 / E10015 Full Dummy.....	\$ 768

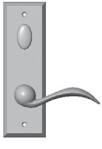



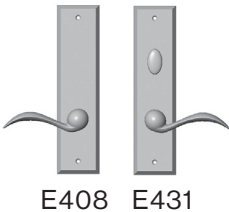
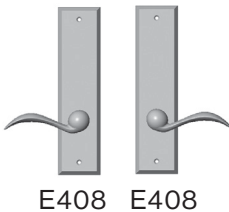
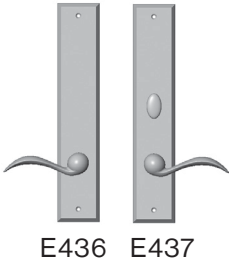
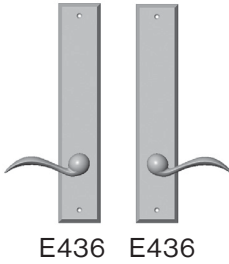
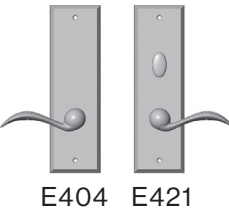
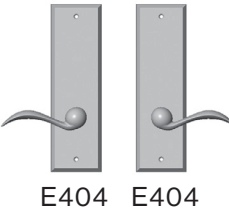
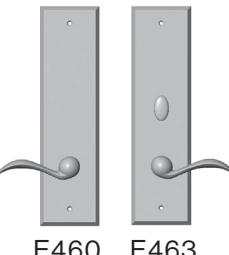
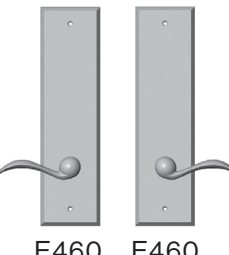

- Price includes your choice of handle except for the Crystal and Glass Knobs (K150, K151, K155, K156), where an upcharge applies. (Knobs not recommended for use with E415 and E416 escutcheons.) Call RMH for pricing.
- Combinations are shown with L105 Beaver Tail Lever for illustration purposes only. Refer to Section A for desired handle.
- Refer to website for door preparatory specifications. Call RMH to verify compatibility of each escutcheon with pre-existing door conditions.
- These escutcheons (E415 and E416) are not compatible with a 2 1/8" face bore.
- Specify metal, patina, handing, backset, door thickness, and lock type.
- Refer to Section B for Escutcheon Specifications.

	ACTIVE	DUMMY	ESCUTCHEON OPTIONS
<b>A</b>	 IP415		<b>A 3 9/16" x 3 9/16" Diamond Escutcheon</b> IP415 Patio Dead Bolt . . . . . \$ 315
<b>B</b>	 IP418		<b>B 2 1/2" x 3" Rectangular Escutcheon</b> IP418 Patio Dead Bolt. . . . . \$ 315
<b>C</b>	 IP415		<b>C 3 9/16" x 3 9/16" Diamond Escutcheon</b> E415 / E415 / IP415 Patio Dead Bolt/ Spring Latch. . . . . \$ 904 E415 Single Dummy . . . . . \$ 246 E415 / E415 Full Dummy . . . . . \$ 492
	  E415 E415	  E415 E415	<b>D 2 5/8" x 2 5/8" Square Escutcheon</b> E416 / E416 / IP418 Patio Dead Bolt/ Spring Latch. . . . . \$ 904 E416 Single Dummy . . . . . \$ 246 E416 / E416 Full Dummy . . . . . \$ 492
<b>D</b>	 IP418		
	  E416 E416	  E416 E416	<b>E 2 1/2" x 4 1/2" Rectangular Escutcheon</b> E414 / E414 / IP418 Patio Dead Bolt/ Spring Latch. . . . . \$ 950 E414 Single Dummy . . . . . \$ 253 E414 / E414 Full Dummy . . . . . \$ 506
<b>E</b>	 IP418		
	  E414 E414	  E414 E414	<b>F 2 1/2" x 8" Rectangular Escutcheon</b> E410 / E412 Patio Dead Bolt/ Spring Latch. . . . . \$ 975 E410 / E412 Patio Mortise Lock . . . . . \$ 1,180 E410 Single Dummy . . . . . \$ 302 E410 / E410 Full Dummy . . . . . \$ 604
<b>F</b>	  E410 E412	  E410 E410	

- Price includes your choice of handle except for the Crystal and Glass Knobs (K150, K151, K155, K156), where an upcharge applies. Call RMH for pricing.
- Combinations are shown with L105 Beaver Tail Lever for illustration purposes only. Refer to Section A for desired handle.
- Refer to website for door preparatory specifications. Call RMH to verify compatibility of each escutcheon with pre-existing door conditions.
- Specify metal, patina, handing, backset, door thickness, and lock type.
- Refer to Section B for Escutcheon Specifications.

	ACTIVE	DUMMY	ESCUTCHEON OPTIONS
<b>A</b>	 <p>E408 E431</p>	 <p>E408 E408</p>	<p><b>A 2 1/2" x 10" Rectangular Escutcheon</b>                      E408 / E431 Patio Dead Bolt/                      Spring Latch . . . . . \$ 1,065                      E408 / E431 Patio Mortise Lock . . . . . \$ 1,273                      E408 Single Dummy . . . . . \$ 349                      E408 / E408 Full Dummy . . . . . \$ 698</p>
<b>B</b>	 <p>E436 E437</p>	 <p>E436 E436</p>	<p><b>B 2 1/2" x 13" Rectangular Escutcheon</b>                      E436 / E437 Patio Dead Bolt/                      Spring Latch . . . . . \$ 1,099                      E436 / E437 Patio Mortise Lock . . . . . \$ 1,307                      E436 Single Dummy . . . . . \$ 367                      E436 / E436 Full Dummy . . . . . \$ 734</p>
<b>C</b>	 <p>E404 E421</p>	 <p>E404 E404</p>	<p><b>C 3" x 10" Rectangular Escutcheon</b>                      E404 / E421 Patio Dead Bolt/                      Spring Latch . . . . . \$ 1,065                      E404 / E421 Patio Mortise Lock . . . . . \$ 1,273                      E404 Single Dummy . . . . . \$ 349                      E404 / E404 Full Dummy . . . . . \$ 698</p>
<b>D</b>	 <p>E460 E463</p>	 <p>E460 E460</p>	<p><b>D 3 1/2" x 13" Rectangular Escutcheon</b>                      E460 / E463 Patio Dead Bolt/                      Spring Latch . . . . . \$ 1,165                      E460 / E463 Patio Mortise Lock . . . . . \$ 1,371                      E460 Single Dummy . . . . . \$ 399                      E460 / E460 Full Dummy . . . . . \$ 798</p>

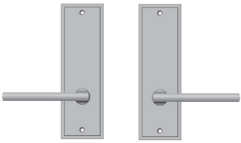

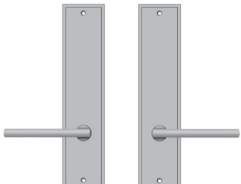

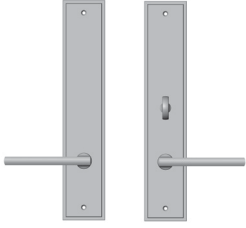
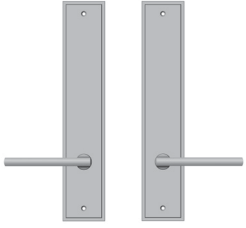
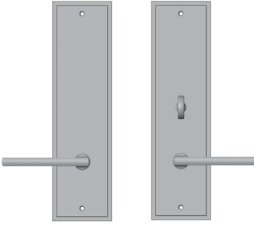
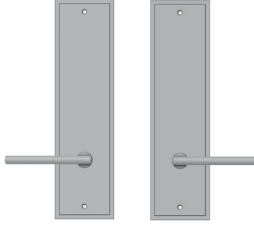

- Price includes your choice of handle except for the Crystal and Glass Knobs (K150, K151, K155, K156), where an upcharge applies. Call RMH for pricing.
- Combinations are shown with L135 Olympus Lever for illustration purposes only. Refer to Section A for desired handle.
- Refer to website for door preparatory specifications. Call RMH to verify compatibility of each escutcheon with pre-existing door conditions.
- Specify metal, patina, handing, backset, door thickness, and lock type.
- Refer to Section B for Escutcheon Specifications.

	ACTIVE	DUMMY	ESCUTCHEON OPTIONS
<b>A</b>	 IP318		<b>A 2 1/2" x 3 1/8" Stepped Escutcheon</b> IP318 Patio Dead Bolt ..... \$ 315
<b>B</b>	 IP318		<b>B 2 1/2" x 4 1/2" Stepped Escutcheon</b> E304 / E304 / IP318 Patio Dead Bolt/ Spring Latch. .... \$ 950 E304 Single Dummy ..... \$ 253 E304 / E304 Full Dummy ..... \$ 506
	 E304 E304	 E304 E304	
<b>C</b>	 E308 E306	 E308 E308	<b>C 2 1/2" x 8" Stepped Escutcheon</b> E308 / E306 Patio Dead Bolt/ Spring Latch. .... \$ 975 E308 / E306 Patio Mortise Lock ..... \$ 1,180 E308 Single Dummy ..... \$ 302 E308 / E308 Full Dummy ..... \$ 604
<b>D</b>	 E312 E313	 E312 E312	<b>D 2 1/2" x 11" Stepped Escutcheon</b> E312 / E313 Patio Dead Bolt/ Spring Latch. .... \$ 1,065 E312 / E313 Patio Mortise Lock ..... \$ 1,273 E312 Single Dummy ..... \$ 349 E312 / E312 Full Dummy ..... \$ 698

- Price includes your choice of handle except for the Crystal and Glass Knobs (K150, K151, K155, K156), where an upcharge applies. Call RMH for pricing.
- Combinations are shown with L135 Olympus Lever for illustration purposes only. Refer to Section A for desired handle.
- Refer to website for door preparatory specifications. Call RMH to verify compatibility of each escutcheon with pre-existing door conditions.
- Specify metal, patina, handing, backset, door thickness, and lock type.
- Refer to Section B for Escutcheon Specifications.

	ACTIVE	DUMMY	ESCUTCHEON OPTIONS
<b>A</b>	 <p>E356 E357</p>	 <p>E356 E356</p>	<p><b>A 2 1/2" x 13" Stepped Escutcheon</b></p> <p>E356 / E357 Patio Dead Bolt/ Spring Latch. . . . . \$ 1,099</p> <p>E356 / E357 Patio Mortise Lock . . . . . \$ 1,307</p> <p>E356 Single Dummy . . . . . \$ 367</p> <p>E356 / E356 Full Dummy . . . . . \$ 734</p>
<b>B</b>	 <p>E360 E363</p>	 <p>E360 E360</p>	<p><b>B 3 1/2" x 13" Stepped Escutcheon</b></p> <p>E360 / E363 Patio Dead Bolt/ Spring Latch. . . . . \$ 1,165</p> <p>E360 / E363 Patio Mortise Lock . . . . . \$ 1,371</p> <p>E360 Single Dummy . . . . . \$ 399</p> <p>E360 / E360 Full Dummy . . . . . \$ 798</p>



- Price includes your choice of handle except for the Crystal and Glass Knobs (K150, K151, K155, K156), where an upcharge applies. (Knobs not recommended for use with E30303 escutcheon.) Call RMH for pricing.
- Combinations are shown with L30301 Trousdale Lever for illustration purposes only. Refer to Section A for desired handle.
- Refer to website for door preparatory specifications. Call RMH to verify compatibility of each escutcheon with pre-existing door conditions.
- This escutcheon (E30303) is not compatible with a 2 1/8" face bore.
- Specify metal, patina, handing, backset, door thickness, and lock type.
- Refer to Section B for Escutcheon Specifications.

	ACTIVE	DUMMY	ESCUTCHEON OPTIONS
<b>A</b>	 IP30390		<b>A 3" Square Trousdale Escutcheon</b> <b>Kravitz Design Collection</b> IP30390 Patio Dead Bolt. . . . . \$ 329
<b>B</b>	 IP30390  E30303 E30303	 E30303 E30303	<b>B 3" Square Trousdale Escutcheon</b> <b>Kravitz Design Collection</b> E30303 / E30303 / IP30390 Patio Dead Bolt/ Spring Latch. . . . . \$ 1,225 E30303 Single Dummy. . . . . \$ 381 E30303 / E30303 Full Dummy. . . . . \$ 762
<b>C</b>	 IP30390  E30305 E30305	 E30305 E30305	<b>C 3" x 6" Trousdale Escutcheon</b> <b>Kravitz Design Collection</b> E30305 / E30305 / IP30390 Patio Dead Bolt/ Spring Latch. . . . . \$ 1,368 E30305 Single Dummy. . . . . \$ 453 E30305 / E30305 Full Dummy. . . . . \$ 906

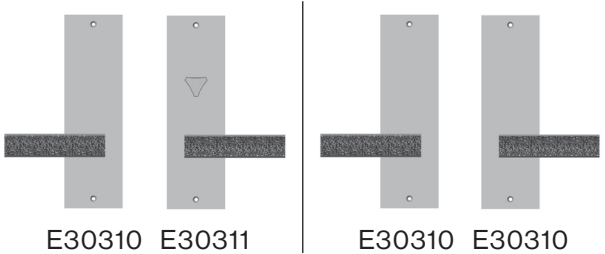
- Price includes your choice of handle except for the Crystal and Glass Knobs (K150, K151, K155, K156), where an upcharge applies. Call RMH for pricing.
- Combinations are shown with L30301 Trousdale Lever for illustration purposes only. Refer to Section A for desired handle.
- Refer to website for door preparatory specifications. Call RMH to verify compatibility of each escutcheon with pre-existing door conditions.
- Specify metal, patina, handing, backset, door thickness, and lock type.
- Refer to Section B for Escutcheon Specifications.

	ACTIVE	DUMMY	ESCUTCHEON OPTIONS
<p><b>A</b></p>  <p style="text-align: center;">E30310 E30311      E30310 E30310</p>			<p><b>A 3" x 10" Trousdale Escutcheon</b>  <b>Kravitz Design Collection</b>                      E30310 / E30311 Patio Dead Bolt/                      Spring Latch. . . . . \$ 1,344                      E30310 / E30311 Patio Mortise Lock . . . . . \$ 1,551                      E30310 Single Dummy . . . . . \$ 480                      E30310 / E30310 Full Dummy . . . . . \$ 960</p>

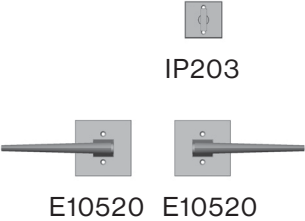
- Combinations are shown with L10501 Verdura Lever. Only available with L10501 and L10502 levers.
- Refer to website for door preparatory specifications. Call RMH to verify compatibility of each escutcheon with pre-existing door conditions.
- This escutcheon (E10520) is not compatible with a 2 1/8" face bore.
- Specify metal, patina, handing, backset, door thickness, and lock type.
- Combinations available with concealed mount. See up-charge below. (IP203 not available with concealed screws)
- Refer to Section B for Escutcheon Specifications.

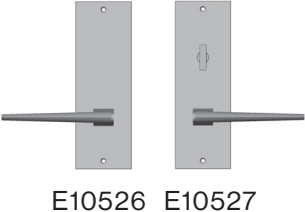
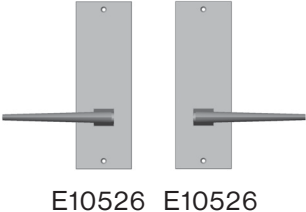
	ACTIVE	DUMMY	ESCUTCHEON OPTIONS
<b>A</b>	 <p>IP203</p> <p>E10520 E10520</p>	 <p>E10520 E10520</p>	<p><b>A 3" x 3" Square Verdura Escutcheon</b></p> <p>E10520 / E10520 / IP203 Patio Dead Bolt Spring Latch..... \$ 1,138</p> <p>E10520 Single Dummy ..... \$ 347</p> <p>E10520 / E10520 Full Dummy ..... \$ 694</p> <p>\$ 97 up-charge per set for concealed mount</p>
<b>B</b>	 <p>E10526 E10527</p>	 <p>E10526 E10526</p>	<p><b>B 3" x 9" Verdura Escutcheon</b></p> <p>E10526 / E10527 Patio Dead Bolt/ Spring Latch..... \$ 1,314</p> <p>E10526 / E10527 Patio Mortise Lock ... \$ 1,500</p> <p>E10526 Single Dummy ..... \$ 487</p> <p>E10526 / E10526 Full Dummy ..... \$ 974</p> <p>\$ 97 up-charge per set for concealed mount</p>