

Sample Order / Cheat Sheet
C Passage Sets 1/3

QUOTE ORDER

NAME: _____

PO# _____

ADDRESS: _____

DELIVERY: _____

OFFICE PHONE: _____

ADDRESS: _____

FAX PHONE: _____

ORDER DATE: _____

CONTACT: _____

JOB NAME: _____

JOB PHONE: _____



HARDWARE WORK ORDER

Toll Free 888.788.2013 or 208.788.2013; Fax 208.788.2577

2002.12.04

LINE NO.	FUNCTION	HANDLE		ESCUTCHEON		METAL	PATINA	HANDING OR LENGTH	BACKSET	DOOR THICKNESS	LOCK TYPE	DEAD BOLT TRIM	DESCRIPTION	LOCATION #	QTY.	PRICE QUOTED
		EXTERIOR	INTERIOR	EXTERIOR	INTERIOR											
1	PA	L102	L102	E414	E414	B	D	L	238	138	SL			1	1	\$ 651
2	PA	K202	K202	E308	E308	W	M	RR	234	134	ML			2	1	\$ 992
3	DU	L110	N	E512	N	B	L	R						3	1	\$ 349
4	DU	K251	K251	E701	E701	W	L							4	1	\$ 579
5	PA	K208	K208	E508	E508	B	M	R	234	134	ML			5	1	\$ 992
6																

FUNCTION
PA = Passage
DU = Dummy

METAL
B = Silicon Bronze
W = White Bronze

BACKSET
238 = 2 3/8" SL
212 = 2 1/2" ML
234 = 2 3/4" SL, ML

DOOR THICKNESS
138 = 13/8"
112 = 11/2"
134 = 13/4"
178 = 17/8"
2 = 2"
214 = 2 1/4"

LOCK TYPE
Complete Sets
SL = Spring Latch
ML = Mortise Lock

DESCRIPTION
See page Ciii for options

QTY
Number of each desired

HANDLE
For a list of Levers, Knobs, and Rings available for Passage Sets, see next page.

PATINA
L = Light
M = Medium
D = Dark
R = Rust
BB = Brushed
DL = Dark Lustre
HP = High Polished *
*Up-charge applies.

Up-charge for sizes below. Call for pricing.

Up-charge for sizes below. Call for pricing.
212 = 2 1/2"
258 = 2 5/8"
234 = 2 3/4"
3 = 3"
314 = 3 1/4"
312 = 3 1/2"
4 = 4"
N = No

DEAD BOLT TRIM
Not Applicable

LOCATION #
Room Number or Door Number, etc.

PRICE
\$ List price each

ESCUTCHEONS
For a list of Escutcheons available for Passage Sets, see next page.

HANDING
See Hinged Door Handing diagram, next page.

334 = 3 3/4" ML
5 = 5" ML
6 = 6" ML
N = No

For configurations, specifications, and pricing, refer to content of this section.

L = Left Hand
R = Right Hand
LR = Left Hand Reverse
RR = Right Hand Reverse

Sample Order / Cheat Sheet**C Passage Sets**

2/3

HANDLE**Levers**

L075 = Ellis Lever
 L101 = Longhorn Lever
 L102 = Squirrel Tail Lever
 L103 = Chub Lever
 L104 = Hook Lever
 L105 = Beaver Tail Lever
 L106 = Talon Lever
 L107 = Slugger Lever
 L108 = Tube Lever
 L109 = Legacy Lever
 L110 = Classic Lever
 L111 = Twig Lever
 L112 = Large Chub Lever
 L113 = Carriage Lever
 L115 = Acanthus Lever
 L116 = Herron Lever
 L117 = French Lever
 L118 = French Twist Lever
 L119 = Long Legacy Lever
 L120 = Long French Lever
 L121 = Rock Creek Lever
 L122 = Large Hook Lever
 L123 = Old World Lever
 L125 = Classic Scroll Lever
 L126 = Triple Twist Lever
 L127 = Scroll Lever
 L128 = Small Classic Lever
 L129 = Trundle Lever
 L130 = Monarch Lever
 L131 = Large Monarch Lever
 L132 = Square Twist Lever
 L135 = Olympus Lever
 L137 = Olympus Return Lever
 L140 = Harrington Lever
 L141 = Large Rock Creek Lever
 L147 = Large Olympus Lever
 L150 = Bella Lever
 L151 = Large Harrington Lever
 L152 = Osprey Lever
 L153 = Talon Return Lever
 L154 = Stalk Lever
 L156 = Large Scroll Lever
 L158 = Large Acanthus Lever
 L159 = Baton Lever
 L160 = Wing Lever
 L163 = Euro Lever
 L164 = Chiseled Lever
 L174 = Lariat Lever
 L175 = Bamboo Lever
 L179 = Twig Return Lever
 L182 = Ribbon & Reed Lever
 L185 = Ore Lever

Levers (continued)

L216 = Old World Return Lever
 L219 = Long Legacy Return Lever
 L224 = Ridge Lever
 L228 = Large Ridge Lever
 L241 = Large French Lever
 L245 = French Return Lever
 L260 = Trolley Lever
 L261 = Rail Lever
 L265 = I Beam Lever
 L267 = Cross Lever
 L276 = Falcon Lever
 L301 = Strap Lever
 L302 = Large Strap Lever
 L303 = Boiler Lever
 L304 = Reed Lever
 L307 = Jane Lever
 L308 = Long Jane Lever
 L310 = Pool Lever
 L311 = Blade Lever
 L314 = UJ Lever
 L330 = Coupler Lever
 L580 = Maddox Lever
 L10010 = Paris Lever
 L10015 = Flute Lever
 L10302 = Raleigh Lever
 L10501 = Verdura Lever**
 L10502 = Verdura Return Lever**
 L10801 = Briggs Lever
 L10802 = Kettle Lever
 L20230 = Shift Lever
 L21005 = Emile Lever
 L30140 = Smith Lever
 L30142 = Whittle Lever
 L30160 = Crown Lever
 L30161 = Capitol Lever
 L30180 = Chateau Lever
 L30301 = Trousdale Lever

Knobs

K075 = Ellis Knob
 K150 = Oval Crystal Knob
 K151 = Oval Cast Glass Knob
 K155 = Round Crystal Knob
 K156 = Round Cast Glass Knob
 K200 = Plymouth Knob
 K201 = Mushroom Knob
 K202 = Hitch Knob
 K203 = Potato Knob
 K204 = Egg Knob
 K205 = Baker Knob
 K206 = Large Luna Knob
 K207 = Luna Knob
 K208 = Gem Knob

Knobs (continued)

K209 = Cottage Knob
 K210 = Prairie Knob
 K211 = Mini Roswell Knob
 K215 = Friedman Knob
 K218 = Elliptic Knob
 K219 = Carriage Knob
 K230 = Acanthus Knob
 K233 = Large Acanthus Knob
 K235 = Cross Knob
 K236 = Ore Knob
 K251 = Roswell Knob
 K268 = Squash Knob
 K580 = Maddox Knob
 K10010 = Quatrafoil Knob
 K10015 = Octagonal Knob
 K10020 = Flute Knob
 K10300 = Flora Knob
 K10801 = Sundial Knob
 K10802 = Kettle Knob
 K21001 = Mack Knob
 K30144 = Smith Knob
 K30164 = Crown Knob
 K30184 = Cabernet Knob
 K30301 = Trousdale Knob
 T300 = T Handle

Rings

RP25 = Ring Pull 2 1/2"
 RP3 = Ring Pull 3"
 RP4 = Ring Pull 4"

ESCUTCHEONS

Arched-Rnd-Oval
 E417 = 2 1/2" Round*
 E418 = 3 1/4" Round*
 E501 = 2 5/8" x 5 1/4" Oval
 E540 = 2 1/2" x 10" Oval
 E701 = 2 1/2" x 5 1/2" Arched
 E702 = 2 1/2" x 9" Arched
 E704 = 2 1/2" x 11" Arched
 E736 = 2 1/2" x 13" Arched
 E706 = 3" x 13" Arched

Bordeaux

E30802 = 2 1/2" Round*
 E30803 = 3 1/4" Round*
 E30806 = 2 1/2" x 5 1/2" Oval
 E30804 = 2 1/2" x 4 1/2" Bordeaux
 E30805 = 2 1/2" x 6" Bordeaux
 E30810 = 2 1/2" x 16 7/16" Bordeaux

Briggs

E10820 = 2 1/2" Round*
 E10871 = 2" x 15" Briggs
 E10800 = 2 3/8" x 7" Briggs

Briggs(Continued)

E10810 = 2 3/8" x 10" Briggs
 E10831 = 3" x 13" Briggs
 E10834 = 3" x 13" Briggs

Convex

E30503 = 2 1/2" x 4 1/2" Convex
 E30506 = 2 1/2" x 8" Convex
 E30508 = 2 1/2" x 10" Convex

Corbel-Arched

E30603 = 2 1/2" x 4 1/2" Corbel Arched
 E30606 = 2 1/2" x 9" Corbel Arched

Corbel-Rectangular

E30703 = 2 1/2" x 4 1/2" Corbel Rect
 E30706 = 2 1/2" x 9" Corbel Rect

Curved

E504 = 2 1/2" x 4 1/2" Curved
 E508 = 2 1/2" x 8" Curved
 E512 = 2 1/2" x 11" Curved
 E556 = 2 1/2" x 13" Curved

Designer

E101 = 3 1/2" Round*
 E103 = 3" x 3" Square*
 E110 = 3" x 8" Designer
 E115 = 3" x 10" Designer

Edge

E153 = 2" x 3" Edge*
 E160 = 2" x 8" Edge
 E165 = 2" x 10" Edge
 E170 = 2" x 13" Edge

Element

E10101 = 1 1/8" Round

Ellis

E005 = 3" x 5" Ellis
 E056 = 3" x 11" Ellis
 E060 = 3" x 13" Ellis

Fleur de Lis

E828 = 2" x 8" Fleur de Lis
 E820 = 2" x 15" Fleur de Lis
 E841 = 2 1/2" x 15" Fleur de Lis
 E832 = 3" x 21" Fleur de Lis

Hammered

E30403 = 2 1/2" x 4 1/2" Hammered
 E30406 = 2 1/2" x 8" Hammered
 E30410 = 2 1/2" x 10" Hammered

Mack

E21005 = 2 1/2" x 4 1/2" Mack
 E21056 = 2 1/2" x 10" Mack
 E21060 = 3 3/4" x 15" Mack

Maddox

E589 = 3 1/8" Round*
 E588 = 2 3/8" x 7 1/2" Maddox
 E585 = 2 1/2" x 10" Maddox
 E584 = 3" x 12 1/2" Maddox
 E570 = 3" x 15" Maddox

Metro

E201 = 2 1/4" Round*
 E202 = 3 1/2" Round*
 E204 = 2 1/4" x 2 1/4" Square*
 E205 = 2 1/4" x 3 1/4" Metro
 E210 = 2 1/4" x 8" Metro
 E206 = 2 1/4" x 10" Metro
 E236 = 2 1/2" x 4 1/2" Metro
 E256 = 2 1/2" x 13" Metro
 E264 = 3 1/2" x 13" Metro

Oasis

E10155 = 3" x 4 1/4" Oasis
 E10203 = 2 1/2" Square Oasis*
 E10205 = 2 1/2" x 4 1/2" Oasis
 E10208 = 2 1/2" x 8 1/2" Oasis
 E10216 = 2 1/2" x 11" Oasis

Roger Thomas Paris Collection

E10010 = 2 1/2" x 6" Paris
 E10015 = 2 1/2" x 9 1/4" Paris

Rectangular-Sq-Dmnd

E416 = 2 5/8" x 2 5/8" Square*
 E415 = 3 9/16" x 3 9/16" Dmnd*
 E414 = 2 1/2" x 4 1/2" Rect
 E410 = 2 1/2" x 8" Rect
 E408 = 2 1/2" x 10" Rect
 E436 = 2 1/2" x 13" Rect
 E404 = 3" x 10" Rect
 E460 = 3 1/2" x 13" Rect

Stepped

E304 = 2 1/2" x 4 1/2" Stepped
 E308 = 2 1/2" x 8" Stepped
 E312 = 2 1/2" x 11" Stepped
 E356 = 2 1/2" x 13" Stepped
 E360 = 3 1/2" x 13" Stepped

Trousdale

E30303 = 3" x 3" Square*
 E30305 = 3" x 6" Trousdale
 E30310 = 3" x 10" Trousdale

Verdura

E10520 = 3" x 3" Square*
 E10526 = 3" x 9" Verdura

Sample Order / Cheat Sheet

C Passage Sets

3/3

* Not recommended for use with knobs.

** Only available with Verdura escutcheons.

Options for "DESCRIPTION" column (pg Ci)

Leather Options

LBK = Black Leather

LBT = Brown Tapestry Leather

LBW = Brown Weave Leather

LCH = Chocolate Leather

LHA = Hazelnut Leather

LSP = Spice Leather

LWH = White Leather

LWI = Wine Leather

Bronze Insert Options

BTW = Weave Insert

BFL = Flower Insert

BTD = Tide Insert

BWD = Wood Insert

BBR = Branch Insert

BBA = Basic Insert

BTF = Tuft Insert

BRT = Flute Insert

Edge Collection Options

ETW = Weave

EWD = Wood

EBA = Basic

ETD = Tide

EWR = Wire

EMS = Mooncape

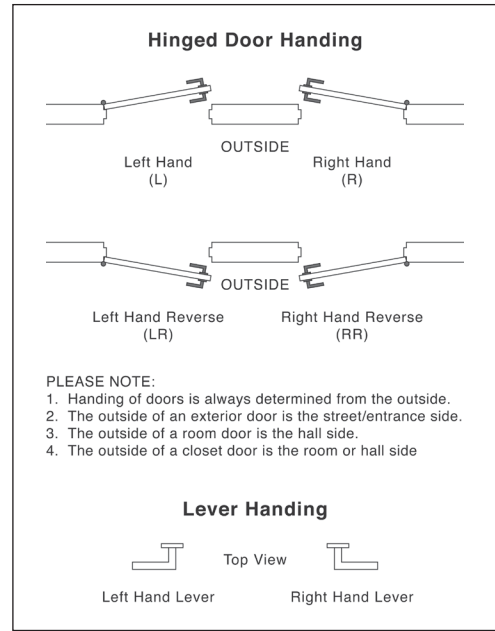
HANDING

Passage Spring Latch Set—Lever to Lever

- 1 Lever
- 2 Escutcheon
- 3 Spring Latch
- 4 T-Strike
- 5 T-Strike Dust Box
- 6 Spindle
- 7 Spindle Spring
- 8 Spindle Retainer

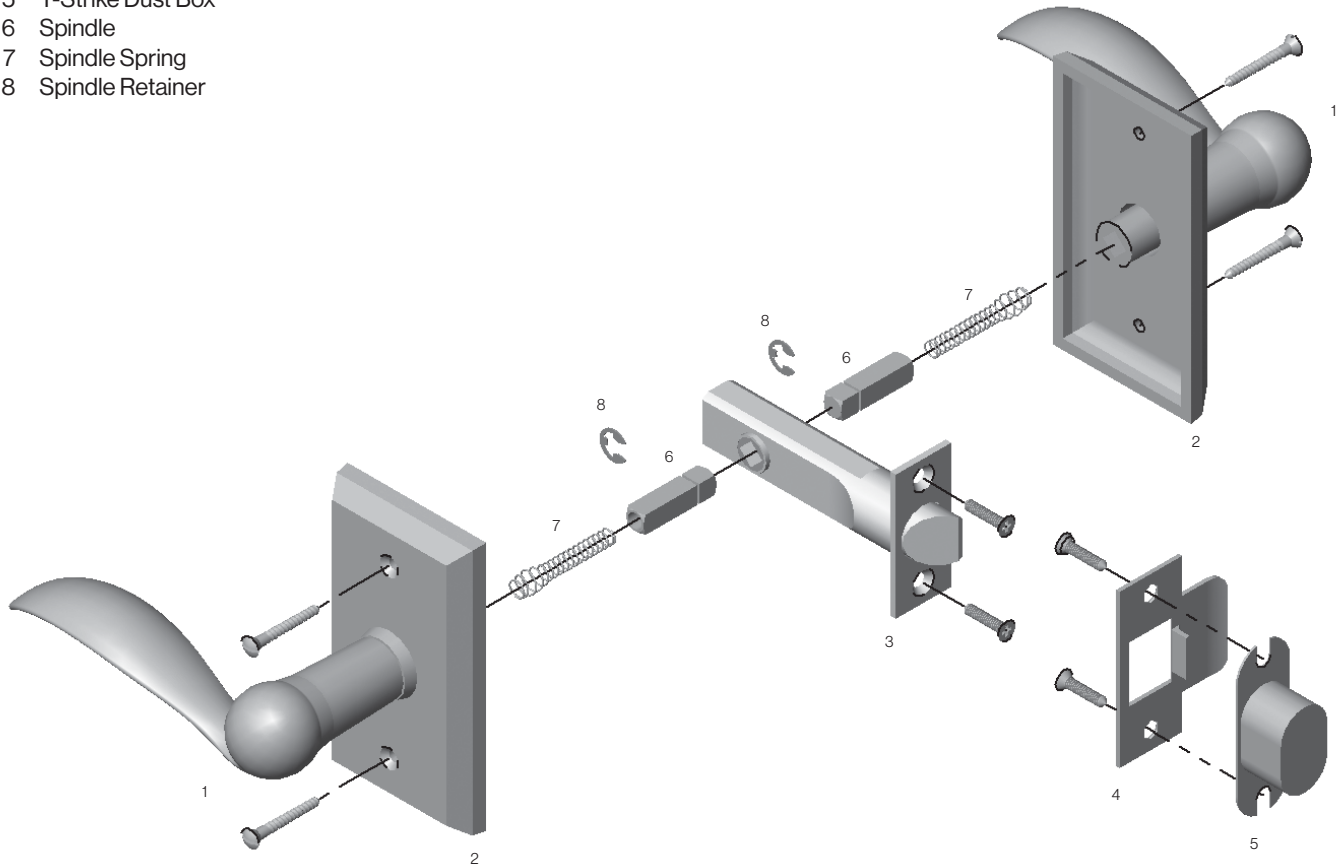





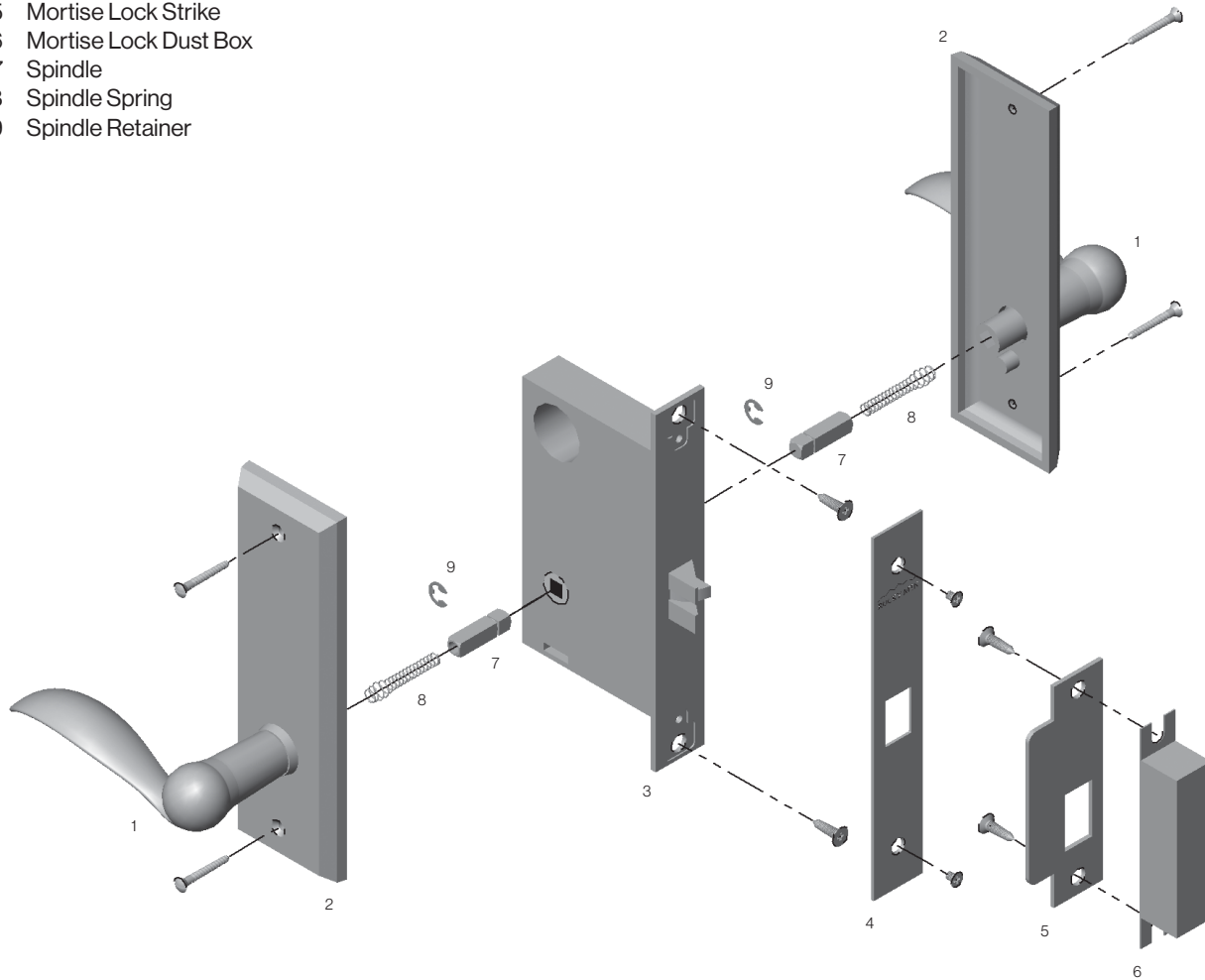











Passage Mortise Lock Set—Lever to Lever









- 1 Lever
- 2 Escutcheon
- 3 Mortise Lock
- 4 Scalp
- 5 Mortise Lock Strike
- 6 Mortise Lock Dust Box
- 7 Spindle
- 8 Spindle Spring
- 9 Spindle Retainer

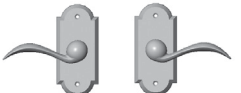
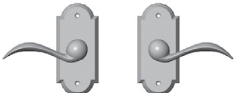







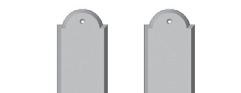













- Price includes your choice of handle except for the Crystal and Glass Knobs (K150, K151, K155, K156), where an upcharge applies. (Knobs not recommended for use with E417 and E418 escutcheons.) Call RMH for pricing.
- Combinations are shown with L105 Beaver Tail Lever for illustration purposes only. Refer to Section A for desired handle.
- Refer to website for door preparatory specifications. Call RMH to verify compatibility of each escutcheon with pre-existing door conditions.
- These escutcheons (E417 and E418) are not compatible with a 2 1/8" face bore.
- Specify metal, patina, handing, backset, door thickness, and lock type.
- Refer to Section B for Escutcheon Specifications.

	ACTIVE	DUMMY	ESCUTCHEON OPTIONS
A	  E417 E417	  E417 E417	A 2 1/2" Round Escutcheon E417 / E417 Passage Spring Latch..... \$ 630 E417 / E417 Passage Mortise Lock \$ 872 E417 Single Dummy..... \$ 245 E417 / E417 Full Dummy \$ 490
B	  E418 E418	  E418 E418	B 3 1/4" Round Escutcheon E418 / E418 Passage Spring Latch \$ 659 E418 / E418 Passage Mortise Lock \$ 901 E418 Single Dummy \$ 259 E418 / E418 Full Dummy \$ 518
C	  E501 E501	  E501 E501	C 2 5/8" x 5 1/4" Oval Escutcheon E501 / E501 Passage Spring Latch \$ 664 E501 / E501 Passage Mortise Lock..... \$ 905 E501 Single Dummy \$ 260 E501 / E501 Full Dummy \$ 520
D	  E540 E540	  E540 E540	D 2 1/2" x 10" Oval Escutcheon E540 / E540 Passage Spring Latch \$ 843 E540 / E540 Passage Mortise Lock..... \$ 1,084 E540 Single Dummy..... \$ 349 E540 / E540 Full Dummy \$ 698

- Price includes your choice of handle except for the Crystal and Glass Knobs (K150, K151, K155, K156), where an upcharge applies. Call RMH for pricing.
- Combinations are shown with L105 Beaver Tail Lever for illustration purposes only. Refer to Section A for desired handle.
- Refer to website for door preparatory specifications. Call RMH to verify compatibility of each escutcheon with pre-existing door conditions.
- Specify metal, patina, handing, backset, door thickness, and lock type.
- Refer to Section B for Escutcheon Specifications.

	ACTIVE	DUMMY	ESCUTCHEON OPTIONS
A	 E701 E701	 E701 E701	A 2 1/2" x 5 1/2" Arched Escutcheon E701 / E701 Passage Spring Latch \$ 724 E701 / E701 Passage Mortise Lock \$ 965 E701 Single Dummy \$ 290 E701 / E701 Full Dummy \$ 580
B	 E702 E702	 E702 E702	B 2 1/2" x 9" Arched Escutcheon E702 / E702 Passage Spring Latch \$ 843 E702 / E702 Passage Mortise Lock \$ 1,084 E702 Single Dummy \$ 349 E702 / E702 Full Dummy \$ 698
C	 E704 E704	 E704 E704	C 2 1/2" x 11" Arched Escutcheon E704 / E704 Passage Spring Latch \$ 843 E704 / E704 Passage Mortise Lock \$ 1,084 E704 Single Dummy \$ 349 E704 / E704 Full Dummy \$ 698
D	 E736 E736	 E736 E736	D 2 1/2" x 13" Arched Escutcheon E736 / E736 Passage Spring Latch \$ 876 E736 / E736 Passage Mortise Lock \$ 1,118 E736 Single Dummy \$ 367 E736 / E736 Full Dummy \$ 734
E	 E706 E706	 E706 E706	E 3" x 13" Arched Escutcheon E706 / E706 Passage Spring Latch \$ 941 E706 / E706 Passage Mortise Lock \$ 1,183 E706 Single Dummy \$ 399 E706 / E706 Full Dummy \$ 798



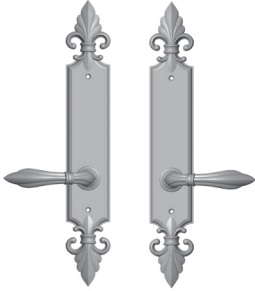
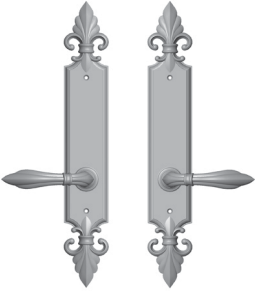

- Price includes your choice of handle except for the Crystal and Glass Knobs (K150, K151, K155, K156), where an upcharge applies. (Knobs not recommended for use with E30802 and E30803 escutcheons.) Call RMH for pricing.
- Combinations are shown with L30180 Chateau Lever for illustration purposes only. Refer to Section A for desired handle.
- Refer to website for door preparatory specifications. Call RMH to verify compatibility of each escutcheon with pre-existing door conditions.
- These escutcheons (E30802 and E30803) are not compatible with a 2 1/8" face bore.
- Specify metal, patina, handing, backset, door thickness, and lock type.
- Refer to Section B for Escutcheon Specifications.

	ACTIVE	DUMMY	ESCUTCHEON OPTIONS
A	  E30802 E30802	  E30802 E30802	A 2 1/2" Round Bordeaux Escutcheon E30802 / E30802 Passage Spring Latch .. \$ 905 E30802 / E30802 Passage Mortise Lock .. \$ 1,149 E30802 Single Dummy \$ 381 E30802 / E30802 Full Dummy \$ 762
B	  E30803 E30803	  E30803 E30803	B 3 1/4" Round Bordeaux Escutcheon E30803 / E30803 Passage Spring Latch .. \$ 905 E30803 / E30803 Passage Mortise Lock .. \$ 1,149 E30803 Single Dummy \$ 381 E30803 / E30803 Full Dummy \$ 762
C	  E30806 E30806	  E30806 E30806	C 2 1/2" x 5 1/2" Oval Bordeaux Escutcheon E30806 / E30806 Passage Spring Latch .. \$ 1,049 E30806 / E30806 Passage Mortise Lock .. \$ 1,290 E30806 Single Dummy \$ 453 E30806 / E30806 Full Dummy \$ 906
D	  E30804 E30804	  E30804 E30804	D 2 1/2" x 4 1/2" Bordeaux Escutcheon E30804 / E30804 Passage Spring Latch .. \$ 1,049 E30804 / E30804 Passage Mortise Lock .. \$ 1,290 E30804 Single Dummy \$ 453 E30804 / E30804 Full Dummy \$ 906
E	  E30805 E30805	  E30805 E30805	E 2 1/2" x 6" Bordeaux Escutcheon E30805 / E30805 Passage Spring Latch .. \$ 1,049 E30805 / E30805 Passage Mortise Lock .. \$ 1,290 E30805 Single Dummy \$ 453 E30805 / E30805 Full Dummy \$ 906

- Price includes your choice of handle except for the Crystal and Glass Knobs (K150, K151, K155, K156), where an upcharge applies. Call RMH for pricing.
- Combinations are shown with L30180 Chateau Lever for illustration purposes only. Refer to Section A for desired handle.
- Refer to website for door preparatory specifications. Call RMH to verify compatibility of each escutcheon with pre-existing door conditions.
- Specify metal, patina, handing, backset, door thickness, and lock type.
- Refer to Section B for Escutcheon Specifications.

	ACTIVE	DUMMY	ESCUTCHEON OPTIONS
A	 <p style="text-align: center;">E30810 E30810</p>	 <p style="text-align: center;">E30810 E30810</p>	<p>A 2 1/2" x 16 7/16" Bordeaux Escutcheon</p> <p>E30810 / E30810 Passage Spring Latch ... \$ 1,168</p> <p>E30810 / E30810 Passage Mortise Lock ... \$ 1,411</p> <p>E30810 Single Dummy \$ 512</p> <p>E30810 / E30810 Full Dummy \$ 1,024</p>

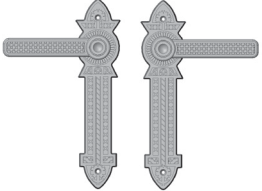
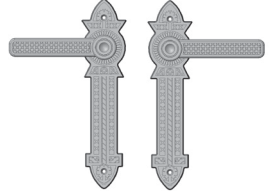

- Price includes your choice of handle except for the Crystal and Glass Knobs (K150, K151, K155, K156), where an upcharge applies. (Knobs not recommended for use with E10820 escutcheon.) Call RMH for pricing.
- Combinations are shown with L10801 Briggs Lever for illustration purposes only. Refer to Section A for desired handle.
- Refer to website for door preparatory specifications. Call RMH to verify compatibility of each escutcheon with pre-existing door conditions.
- This escutcheon (E10820) is not compatible with a 2 1/8" face bore.
- Specify metal, patina, handing, backset, door thickness, and lock type.
- Refer to Section B for Escutcheon Specifications.

	ACTIVE	DUMMY	ESCUTCHEON OPTIONS
A	 E10820 E10820	 E10820 E10820	A 2 1/2" Round Briggs Escutcheon E10820 / E10820 Passage Spring Latch . . . \$ 630 E10820 / E10820 Passage Mortise Lock . . . \$ 872 E10820 Single Dummy \$ 245 E10820 / E10820 Full Dummy \$ 490
B	 E10800 E10800	 E10800 E10800	B 2 3/8" x 7" Briggs Escutcheon E10800 / E10800 Passage Spring Latch . . . \$ 756 E10800 / E10800 Passage Mortise Lock . . . \$ 999 E10800 Single Dummy \$ 306 E10800 / E10800 Full Dummy \$ 612
C	 E10810 E10810	 E10810 E10810	C 2 3/8" x 10" Briggs Escutcheon E10810 / E10810 Passage Spring Latch . . . \$ 843 E10810 / E10810 Passage Mortise Lock . . . \$ 1,084 E10810 Single Dummy \$ 349 E10810 / E10810 Full Dummy \$ 698

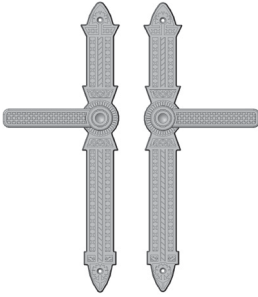
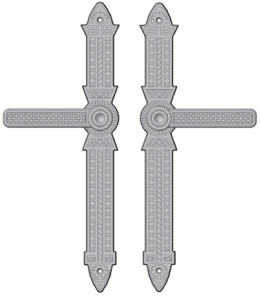
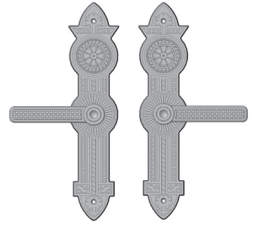
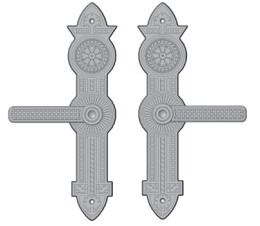
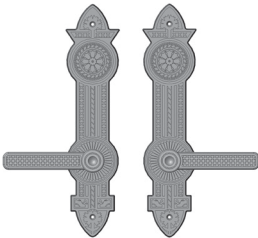
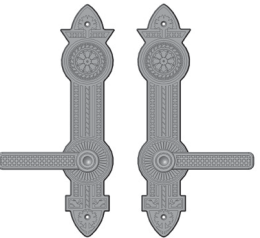

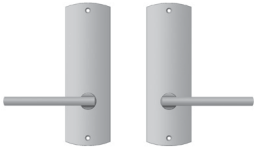
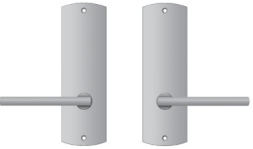
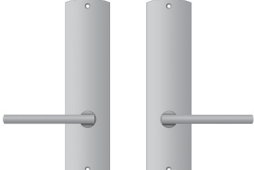
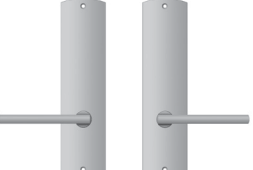

- Price includes your choice of handle except for the Crystal and Glass Knobs (K150, K151, K155, K156), where an upcharge applies. Call RMH for pricing.
- Combinations are shown with L10801 Briggs Lever for illustration purposes only. Refer to Section A for desired handle.
- Refer to website for door preparatory specifications. Call RMH to verify compatibility of each escutcheon with pre-existing door conditions.
- This escutcheon (E10871) is not compatible with a 2 1/8" face bore.
- Specify metal, patina, handing, backset, door thickness, and lock type.
- Refer to Section B for Escutcheon Specifications.

	ACTIVE	DUMMY	ESCUTCHEON OPTIONS
A	 E10871	 E10871	A 2" x 15" Briggs Escutcheon E10871 / E10871 Passage Spring Latch \$ 843 E10871 / E10871 Passage Mortise Lock \$ 1,084 E10871 Single Dummy \$ 349 E10871 / E10871 Full Dummy \$ 698
B	 E10831	 E10831	B 3" x 13" Briggs Escutcheon E10831 / E10831 Passage Spring Latch \$ 941 E10831 / E10831 Passage Mortise Lock \$ 1,183 E10831 Single Dummy \$ 399 E10831 / E10831 Full Dummy \$ 798
C	 E10834	 E10834	C 3" x 13" Briggs Escutcheon E10834 / E10834 Passage Spring Latch \$ 941 E10834 / E10834 Passage Mortise Lock \$ 1,183 E10834 Single Dummy \$ 399 E10834 / E10834 Full Dummy \$ 798

- Price includes your choice of handle except for the Crystal and Glass Knobs (K150, K151, K155, K156), where an upcharge applies. Call RMH for pricing.
- Combinations are shown with L135 Olympus Lever for illustration purposes only. Refer to Section A for desired handle.
- Refer to website for door preparatory specifications. Call RMH to verify compatibility of each escutcheon with pre-existing door conditions.
- Specify metal, patina, handing, backset, door thickness, and lock type.
- Refer to Section B for Escutcheon Specifications.

	ACTIVE	DUMMY	ESCUTCHEON OPTIONS
A	 E30503 E30503	 E30503 E30503	A 2 1/2" x 4 1/2" Convex Escutcheon E30503 / E30503 Passage Spring Latch ... \$ 1,049 E30503 / E30503 Passage Mortise Lock ... \$ 1,290 E30503 Single Dummy \$ 453 E30503 / E30503 Full Dummy \$ 906
B	 E30506 E30506	 E30506 E30506	B 2 1/2" x 8" Convex Escutcheon E30506 / E30506 Passage Spring Latch ... \$ 1,077 E30506 / E30506 Passage Mortise Lock ... \$ 1,318 E30506 Single Dummy \$ 467 E30506 / E30506 Full Dummy \$ 934
C	 E30508 E30508	 E30508 E30508	C 2 1/2" x 10" Convex Escutcheon E30508 / E30508 Passage Spring Latch ... \$ 1,106 E30508 / E30508 Passage Mortise Lock ... \$ 1,349 E30508 Single Dummy \$ 480 E30508 / E30508 Full Dummy \$ 960

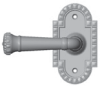

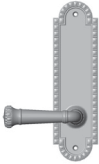
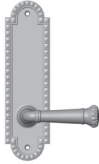
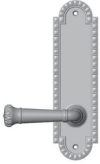
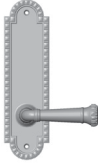

- Price includes your choice of handle except for the Crystal and Glass Knobs (K150, K151, K155, K156), where an upcharge applies. Call RMH for pricing.
- Combinations are shown with L30160 Crown Lever for illustration purposes only. Refer to Section A for desired handle.
- Refer to website for door preparatory specifications. Call RMH to verify compatibility of each escutcheon with pre-existing door conditions.
- Specify metal, patina, handing, backset, door thickness, and lock type.
- Refer to Section B for Escutcheon Specifications.

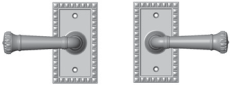
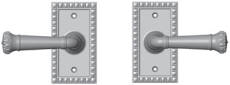
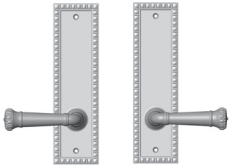
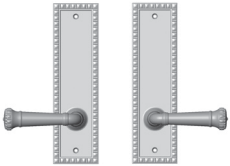
	ACTIVE	DUMMY	ESCUTCHEON OPTIONS
A	  E30603 E30603	  E30603 E30603	A 2 1/2" x 4 1/2" Corbel Arched Escutcheon E30603 / E30603 Passage Spring Latch .. \$ 1,049 E30603 / E30603 Passage Mortise Lock .. \$ 1,290 E30603 Single Dummy \$ 453 E30603 / E30603 Full Dummy \$ 906
B	  E30606 E30606	  E30606 E30606	B 2 1/2" x 9" Corbel Arched Escutcheon E30606 / E30606 Passage Spring Latch .. \$ 1,106 E30606 / E30606 Passage Mortise Lock .. \$ 1,349 E30606 Single Dummy \$ 480 E30606 / E30606 Full Dummy \$ 960 Refer to spec page B31



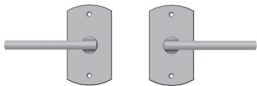

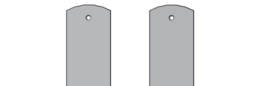
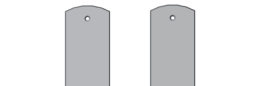
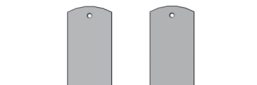
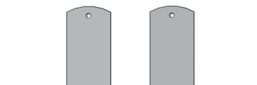
- Price includes your choice of handle except for the Crystal and Glass Knobs (K150, K151, K155, K156), where an upcharge applies. Call RMH for pricing.
- Combinations are shown with L30160 Crown Lever for illustration purposes only. Refer to Section A for desired handle.
- Refer to website for door preparatory specifications. Call RMH to verify compatibility of each escutcheon with pre-existing door conditions.
- Specify metal, patina, handing, backset, door thickness, and lock type.
- Refer to Section B for Escutcheon Specifications.

	ACTIVE	DUMMY	ESCUTCHEON OPTIONS
A	 E30703 E30703	 E30703 E30703	A 2 1/2" x 4 1/2" Corbel Rectangular Escutcheon E30703 / E30703 Passage Spring Latch... \$ 1,049 E30703 / E30703 Passage Mortise Lock .. \$ 1,290 E30703 Single Dummy \$ 453 E30703 / E30703 Full Dummy \$ 906
B	 E30706 E30706	 E30706 E30706	B 2 1/2" x 9" Corbel Rectangular Escutcheon E30706 / E30706 Passage Spring Latch... \$ 1,106 E30706 / E30706 Passage Mortise Lock .. \$ 1,349 E30706 Single Dummy \$ 480 E30706 / E30706 Full Dummy \$ 960







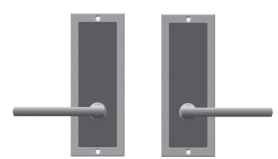
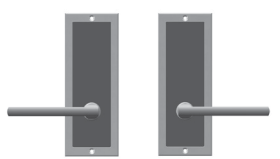
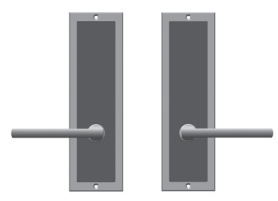
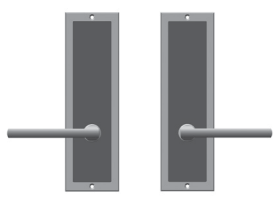













- Price includes your choice of handle except for the Crystal and Glass Knobs (K150, K151, K155, K156), where an upcharge applies. Call RMH for pricing.
- Combinations are shown with L135 Olympus Lever for illustration purposes only. Refer to Section A for desired handle.
- Refer to website for door preparatory specifications. Call RMH to verify compatibility of each escutcheon with pre-existing door conditions.
- Specify metal, patina, handing, backset, door thickness, and lock type.
- Refer to Section B for Escutcheon Specifications.

	ACTIVE	DUMMY	ESCUTCHEON OPTIONS
A	 E504 E504	 E504 E504	A 2 1/2" x 4 1/2" Curved Escutcheon E504 / E504 Passage Spring Latch . . . \$ 652 E504 / E504 Passage Mortise Lock . . . \$ 893 E504 Single Dummy \$ 253 E504 / E504 Full Dummy \$ 506
B	 E508 E508	 E508 E508	B 2 1/2" x 8" Curved Escutcheon E508 / E508 Passage Spring Latch . . . \$ 748 E508 / E508 Passage Mortise Lock . . . \$ 992 E508 Single Dummy \$ 302 E508 / E508 Full Dummy \$ 604
C	 E512 E512	 E512 E512	C 2 1/2" x 11" Curved Escutcheon E512 / E512 Passage Spring Latch \$ 843 E512 / E512 Passage Mortise Lock \$ 1,084 E512 Single Dummy \$ 349 E512 / E512 Full Dummy \$ 698
D	 E556 E556	 E556 E556	D 2 1/2" x 13" Curved Escutcheon E556 / E556 Passage Spring Latch . . . \$ 876 E556 / E556 Passage Mortise Lock . . . \$ 1,118 E556 Single Dummy \$ 367 E556 / E556 Full Dummy \$ 734





- Price includes your choice of handle except for the Crystal and Glass Knobs (K150, K151, K155, K156), where an upcharge applies. (Knobs not recommended for use with E101 and E103 escutcheons.) Call RMH for pricing.
- Combinations are shown with L135 Olympus Lever for illustration purposes only. Refer to Section A for desired handle.
- Refer to website for door preparatory specifications. Call RMH to verify compatibility of each escutcheon with pre-existing door conditions.
- These escutcheons (E101 and E103) are not compatible with 2 1/8" face bore.
- Specify metal, patina, leather or texture, handing, backset, door thickness, and lock type.
- Refer to page Ci for leather and texture options. See website or brochure for details.
- Refer to Section B for Escutcheon Specifications.

	ACTIVE	DUMMY	ESCUTCHEON OPTIONS
A	 E101 E101	 E101 E101	A 3 1/2" Round Designer Escutcheon E101 / E101 Passage Spring Latch \$ 1,287 E101 / E101 Passage Mortise Lock \$ 1,529 E101 Single Dummy \$ 571 E101 / E101 Full Dummy \$ 1,142
B	 E103 E103	 E103 E103	B 3" x 3" Square Designer Escutcheon E103 / E103 Passage Spring Latch \$ 1,287 E103 / E103 Passage Mortise Lock \$ 1,529 E103 Single Dummy \$ 571 E103 / E103 Full Dummy \$ 1,142
C	 E110 E110	 E110 E110	C 3" x 8" Designer Escutcheon E110 / E110 Passage Spring Latch \$ 1,529 E110 / E110 Passage Mortise Lock \$ 1,716 E110 Single Dummy \$ 712 E110 / E110 Full Dummy \$ 1,424
D	 E115 E115	 E115 E115	D 3" x 10" Designer Escutcheon E115 / E115 Passage Spring Latch \$ 1,617 E115 / E115 Passage Mortise Lock \$ 1,859 E115 Single Dummy \$ 737 E115 / E115 Full Dummy \$ 1,474 Refer to spec page B47

- Price includes your choice of handle except for the Crystal and Glass Knobs (K150, K151, K155, K156), where an upcharge applies. (Knobs not recommended for use with E153 escutcheons.) Call RMH for pricing.
- Combinations are shown with L304 Reed Lever for illustration purposes only. Refer to Section A for desired handle.
- Refer to website for door preparatory specifications. Call RMH to verify compatibility of each escutcheon with pre-existing door conditions.
- These escutcheons (E153, E160, E165, and E170) are not compatible with a 2 1/8" face bore.
- Specify metal, style, patina, handing, backset, door thickness, and lock type.
- Requires a minimum of 1 3/4" door thickness.
- Refer to Section B for Escutcheon Specifications.

	ACTIVE	DUMMY	ESCUTCHEON OPTIONS
A	  E153 E153	  E153 E153	A 2" x 3" Edge Escutcheon E153 / E153 Passage Spring Latch \$ 651 E153 / E153 Passage Mortise Lock \$ 853 E153 Single Dummy \$ 253 E153 / E153 Full Dummy \$ 506
B	  E160 E160	  E160 E160	B 2" x 8" Edge Escutcheon E160 / E160 Passage Spring Latch \$ 748 E160 / E160 Passage Mortise Lock \$ 992 E160 Single Dummy \$ 302 E160 / E160 Full Dummy \$ 604
C	  E165 E165	  E165 E165	C 2" x 10" Edge Escutcheon E165 / E165 Passage Spring Latch \$ 843 E165 / E165 Passage Mortise Lock \$ 1,084 E165 Single Dummy \$ 349 E165 / E165 Full Dummy \$ 698
D	  E170 E170	  E170 E170	D 2" x 13" Edge Escutcheon E170 / E170 Passage Spring Latch \$ 876 E170 / E170 Passage Mortise Lock \$ 1,118 E170 Single Dummy \$ 367 E170 / E170 Full Dummy \$ 734
E	  E140 E140	  E140 E140	E 2 1/2" x 13" Edge Escutcheon E140 / E140 Passage Spring Latch \$ 876 E140 / E140 Passage Mortise Lock \$ 1,118 E140 Single Dummy \$ 367 E140 / E140 Full Dummy \$ 734

- Price includes your choice of handle except for the Crystal and Glass Knobs (K150, K151, K155, K156), where an upcharge applies. Call RMH for pricing. Rings are not recommended for Element Collection.
- Combinations are shown with L135 Olympus Lever for illustration purposes only. Refer to Section A for desired handle.
- Refer to website for door preparatory specifications.
- Max door thickness of 3" is applicable with lock centered, call for pricing when lock is offset.
- Minimum door thickness of 1 3/4" is applicable.
- This escutcheon (E10101) is not compatible with a 2 1/8" face bore.
- Specify metal, patina, handing, backset, door thickness, and lock type.
- Specify if double door application with active Dummy panels. Refer to door preparatory specifications for additional information.
- Refer to Section B for Escutcheon Specifications.

	ACTIVE		DUMMY		ESCUTCHEON OPTIONS
A					A 1 1/8" Round Element Escutcheon
	E10101	E10101	E10101	E10101	E10101 / E10101 Passage Mortise Lock... \$ 1,084
					E10101 Single Dummy..... \$ 495
					E10101 / E10101 Full Dummy..... \$ 843

- Price includes your choice of handle except for the Crystal and Glass Knobs (K150, K151, K155, K156), where an upcharge applies. Call RMH for pricing.
- Combinations are shown with L075 Ellis Lever for illustration purposes only. Refer to Section A for desired handle.
- Refer to website for door preparatory specifications. Call RMH to verify compatibility of each escutcheon with pre-existing door conditions.
- Specify metal, patina, handing, backset, door thickness, and lock type.
- Refer to Section B for Escutcheon Specifications.

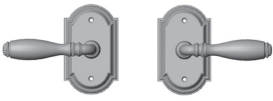
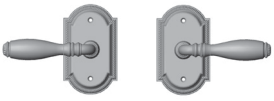
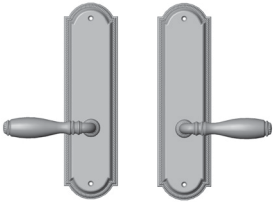
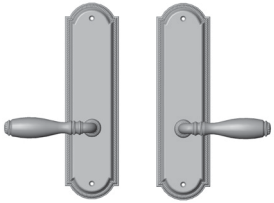
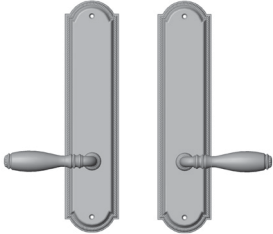
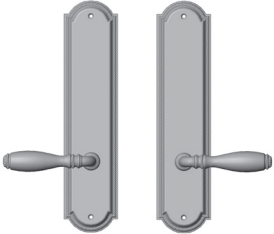
	ACTIVE	DUMMY	ESCUTCHEON OPTIONS
A	 E005 E005	 E005 E005	A 3" x 5" Ellis Escutcheon E005 / E005 Passage Spring Latch . . . \$ 1,049 E005 / E005 Passage Mortise Lock . . . \$ 1,290 E005 Single Dummy \$ 453 E005 / E005 Full Dummy \$ 906
B	 E056 E056	 E056 E056	B 3" x 11" Ellis Escutcheon E056 / E056 Passage Spring Latch . . . \$ 1,106 E056 / E056 Passage Mortise Lock . . . \$ 1,349 E056 Single Dummy \$ 480 E056 / E056 Full Dummy \$ 960
C	 E060 E060	 E060 E060	C 3" x 13" Ellis Escutcheon E060 / E060 Passage Spring Latch . . . \$ 1,168 E060 / E060 Passage Mortise Lock . . . \$ 1,411 E060 Single Dummy \$ 512 E060 / E060 Full Dummy \$ 1,024 Refer to spec page B62



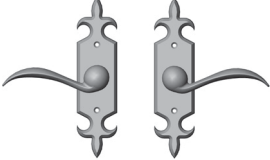
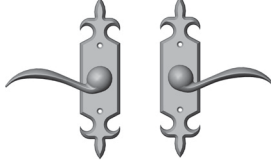
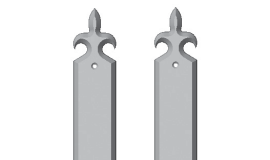
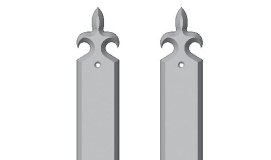
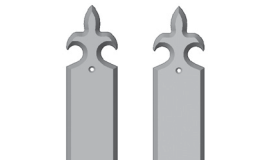
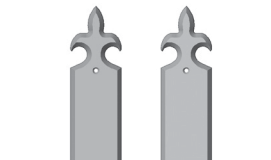
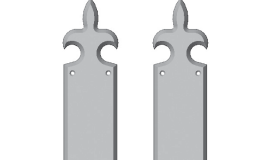
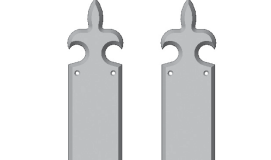

- Price includes your choice of handle except for the Crystal and Glass Knobs (K150, K151, K155, K156), where an upcharge applies. Call RMH for pricing.
- Combinations are shown with L105 Beaver Tail Lever for illustration purposes only. Refer to Section A for desired handle.
- Refer to website for door preparatory specifications. Call RMH to verify compatibility of each escutcheon with pre-existing door conditions.
- These escutcheons (E828 and E820) are not compatible with 2 1/8" face bore.
- Specify metal, patina, handing, backset, door thickness, and lock type.
- Refer to Section B for Escutcheon Specifications.

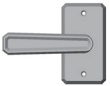
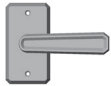
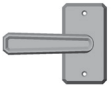
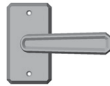
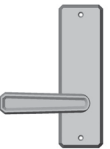
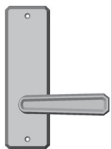
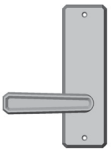
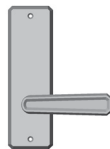
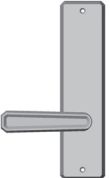
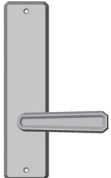
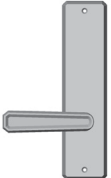
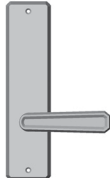
	ACTIVE	DUMMY	ESCUTCHEON OPTIONS
A	 E828 E828	 E828 E828	A 2" x 8" Fleur De Lis Escutcheon E828 / E828 Passage Spring Latch . . . \$ 748 E828 / E828 Passage Mortise Lock . . . \$ 992 E828 Single Dummy \$ 302 E828 / E828 Full Dummy \$ 604
B	 E820 E820	 E820 E820	B 2" x 15" Fleur De Lis Escutcheon E820 / E820 Passage Spring Latch . . . \$ 843 E820 / E820 Passage Mortise Lock . . . \$ 1,084 E820 Single Dummy \$ 349 E820 / E820 Full Dummy \$ 698
C	 E841 E841	 E841 E841	C 2 1/2" x 15" Fleur De Lis Escutcheon E841 / E841 Passage Spring Latch \$ 876 E841 / E841 Passage Mortise Lock \$ 1,118 E841 Single Dummy \$ 367 E841 / E841 Full Dummy \$ 734
D	 E832 E832	 E832 E832	D 3" x 21" Fleur De Lis Escutcheon E832 / E832 Passage Spring Latch . . . \$ 1,141 E832 / E832 Passage Mortise Lock . . . \$ 1,374 E832 Single Dummy \$ 500 E832 / E832 Full Dummy \$1,000

- Price includes your choice of handle except for the Crystal and Glass Knobs (K150, K151, K155, K156), where an upcharge applies. Call RMH for pricing.
- Combinations are shown with L30140 Smith Lever for illustration purposes only. Refer to Section A for desired handle.
- Refer to website for door preparatory specifications. Call RMH to verify compatibility of each escutcheon with pre-existing door conditions.
- Specify metal, patina, handing, backset, door thickness, and lock type.
- Refer to Section B for Escutcheon Specifications.

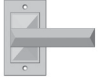
	ACTIVE	DUMMY	ESCUTCHEON OPTIONS
A	  E30403 E30403	  E30403 E30403	A 2 1/2" x 4 1/2" Hammered Escutcheon E30403 / E30403 Passage Spring Latch ..\$ 651 E30403 / E30403 Passage Mortise Lock ..\$ 893 E30403 Single Dummy.....\$ 253 E30403 / E30403 Full Dummy.....\$ 506
B	  E30406 E30406	  E30406 E30406	B 2 1/2" x 8" Hammered Escutcheon E30406 / E30406 Passage Spring Latch ..\$ 748 E30406 / E30406 Passage Mortise Lock ..\$ 992 E30406 Single Dummy.....\$ 302 E30406 / E30406 Full Dummy.....\$ 604
C	  E30410 E30410	  E30410 E30410	C 2 1/2" x 10" Hammered Escutcheon E30410 / E30410 Passage Spring Latch ...\$ 843 E30410 / E30410 Passage Mortise Lock ...\$ 1,084 E30410 Single Dummy\$ 349 E30410 / E30410 Full Dummy\$ 698 Refer to spec page B72

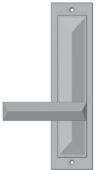
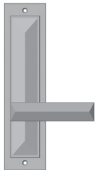
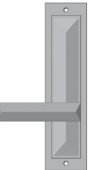

- Price includes your choice of handle except for the Crystal and Glass Knobs (K150, K151, K155, K156), where an upcharge applies. Call RMH for pricing.
- Combinations are shown with L21005 Emile Lever for illustration purposes only. Refer to Section A for desired handle.
- Refer to website for door preparatory specifications. Call RMH to verify compatibility of each escutcheon with pre-existing door conditions.
- Specify metal, patina, handing, backset, door thickness, and lock type.
- Refer to Section B for Escutcheon Specifications.

	ACTIVE	DUMMY	ESCUTCHEON OPTIONS
A	  E21005 E21005	  E21005 E21005	A 2 1/2" x 4 1/2" Mack Escutcheon E21005/E21005 Passage Spring Latch . . . \$ 651 E21005/E21005 Passage Mortise Lock . . . \$ 893 E21005 Single Dummy \$ 253 E21005 / E21005 Full Dummy \$ 506
B	  E21056 E21056	  E21056 E21056	B 2 1/2" x 10" Mack Escutcheon E21056/E21056 Passage Spring Latch . . . \$ 843 E21056/E21056 Passage Mortise Lock . . . \$ 1,084 E21056 Single Dummy \$ 349 E21056 / E21056 Full Dummy \$ 698

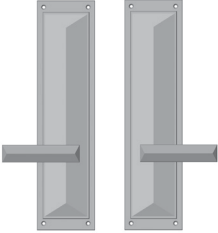
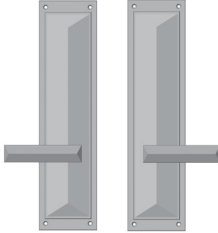





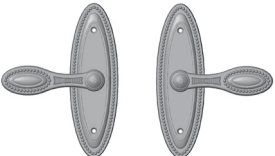
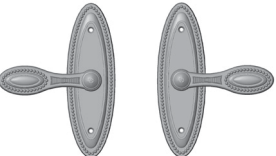
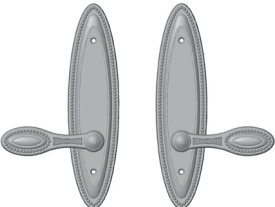
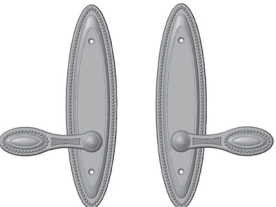
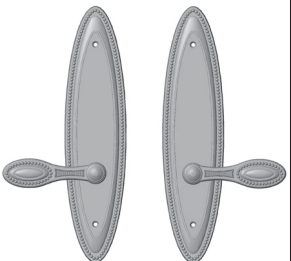
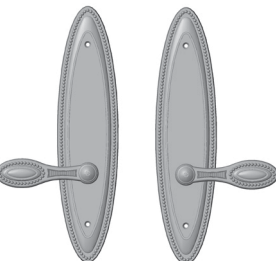
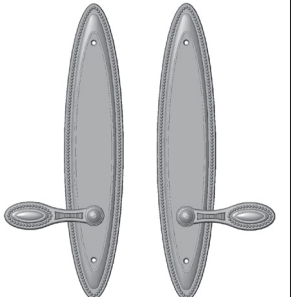
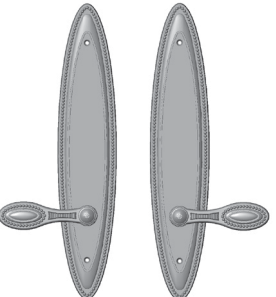



- Price includes your choice of handle except for the Crystal and Glass Knobs (K150, K151, K155, K156), where an upcharge applies. Call RMH for pricing.
- Combinations are shown with L21005 Emile Lever for illustration purposes only. Refer to Section A for desired handle.
- Refer to website for door preparatory specifications. Call RMH to verify compatibility of each escutcheon with pre-existing door conditions.
- Specify metal, patina, handing, backset, door thickness, and lock type.
- This escutcheon (E21060) requires a backset that is 2 1/2" or greater.
- Refer to Section B for Escutcheon Specifications.

	ACTIVE	DUMMY	ESCUTCHEON OPTIONS
A	 <p>E21060 E21060</p>	 <p>E21060 E21060</p>	<p>A 3 3/4" x 15" Mack Escutcheon</p> <p>E21060 / E21060 Passage Spring Latch ... \$ 1,141</p> <p>E21060 / E21060 Passage Mortise Lock ... \$ 1,374</p> <p>E21060 Single Dummy \$ 500</p> <p>E21060 / E21060 Full Dummy \$ 1,000</p>







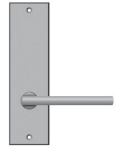
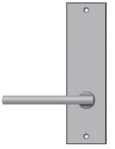
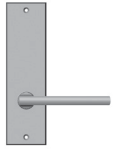

- Price includes your choice of handle except for the Crystal and Glass Knobs (K150, K151, K155, K156), where an upcharge applies. (Knobs not recommended for use with E589 escutcheon.) Call RMH for pricing.
- Combinations are shown with L580 Maddox Lever for illustration purposes only. Refer to Section A for desired handle.
- Refer to website for door preparatory specifications. Call RMH to verify compatibility of each escutcheon with pre-existing door conditions.
- This escutcheon (E589) is not compatible with 2 1/8" face bore.
- Specify metal, patina, handing, backset, door thickness, and lock type.
- Refer to Section B for Escutcheon Specifications.

	ACTIVE	DUMMY	ESCUTCHEON OPTIONS
A	 E589 E589	 E589 E589	A 3 1/8" Round Maddox Escutcheon E589 / E589 Passage Spring Latch \$ 905 E589 / E589 Passage Mortise Lock \$ 1,149 E589 Single Dummy \$ 381 E589 / E589 Full Dummy \$ 762
B	 E588 E588	 E588 E588	B 2 3/8" x 7 1/2" Maddox Escutcheon E588 / E588 Passage Spring Latch \$ 1,049 E588 / E588 Passage Mortise Lock \$ 1,290 E588 Single Dummy \$ 453 E588 / E588 Full Dummy \$ 906
C	 E585 E585	 E585 E585	C 2 1/2" x 10" Maddox Escutcheon E585 / E585 Passage Spring Latch \$ 1,106 E585 / E585 Passage Mortise Lock \$ 1,349 E585 Single Dummy \$ 480 E585 / E585 Full Dummy \$ 960
D	 E584 E584	 E584 E584	D 3" x 12 1/2" Maddox Escutcheon E584 / E584 Passage Spring Latch \$ 1,168 E584 / E584 Passage Mortise Lock \$ 1,411 E584 Single Dummy \$ 512 E584 / E584 Full Dummy \$ 1,024
E	 E570 E570	 E570 E570	E 3" x 15" Maddox Escutcheon E570 / E570 Passage Spring Latch \$ 1,300 E570 / E570 Passage Mortise Lock \$ 1,543 E570 Single Dummy \$ 578 E570 Full Dummy \$ 1,156

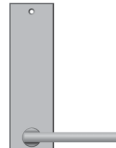
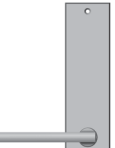
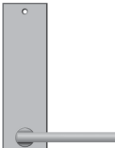

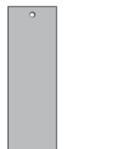

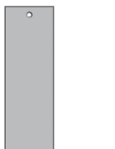

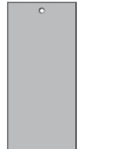
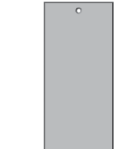
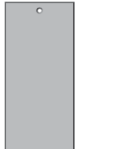



- Price includes your choice of handle except for the Crystal and Glass Knobs (K150, K151, K155, K156), where an upcharge applies. (Knobs not recommended for use with E201, E202, E204, and E205 escutcheons.) Call RMH for pricing.
- Combinations are shown with L135 Olympus Lever for illustration purposes only. Refer to Section A for desired handle.
- Refer to website for door preparatory specifications. Call RMH to verify compatibility of each escutcheon with pre-existing door conditions.
- These escutcheons (E201, E202, E204, and E205) are not compatible with a 2 1/8" face bore.
- Specify metal, patina, handing, backset, door thickness, and lock type.
- Refer to Section B for Escutcheon Specifications.

	ACTIVE	DUMMY	ESCUTCHEON OPTIONS
A	 E201 E201	 E201 E201	A 2 1/4" Round Metro Escutcheon E201 / E201 Passage Spring Latch \$ 630 E201 / E201 Passage Mortise Lock \$ 871 E201 Single Dummy \$ 245 E201 / E201 Full Dummy \$ 490
B	 E202 E202	 E202 E202	B 3 1/2" Round Metro Escutcheon E202 / E202 Passage Spring Latch . . . \$ 692 E202 / E202 Passage Mortise Lock . . . \$ 932 E202 Single Dummy \$ 274 E202 / E202 Full Dummy \$ 548
C	 E204 E204	 E204 E204	C 2 1/4" x 2 1/4" Square Metro Escutcheon E204 / E204 Passage Spring Latch . . . \$ 635 E204 / E204 Passage Mortise Lock . . . \$ 876 E204 Single Dummy \$ 246 E204 / E204 Full Dummy \$ 492
D	 E205 E205	 E205 E205	D 2 1/4" x 3 1/4" Metro Escutcheon E205 / E205 Passage Spring Latch . . . \$ 651 E205 / E205 Passage Mortise Lock . . . \$ 893 E205 Single Dummy \$ 253 E205 / E205 Full Dummy \$ 506
E	 E236 E236	 E236 E236	E 2 1/2" x 4 1/2" Metro Escutcheon E236 / E236 Passage Spring Latch . . . \$ 651 E236 / E236 Passage Mortise Lock . . . \$ 893 E236 Single Dummy \$ 253 E236 / E236 Full Dummy \$ 506



- Price includes your choice of handle except for the Crystal and Glass Knobs (K150, K151, K155, K156), where an upcharge applies. Call RMH for pricing.
- Combinations are shown with L135 Olympus Lever for illustration purposes only. Refer to Section A for desired handle.
- Refer to website for door preparatory specifications. Call RMH to verify compatibility of each escutcheon with pre-existing door conditions.
- This escutcheon (E206 and E210) is not compatible with a 2 1/8" face bore.
- Specify metal, patina, handing, backset, door thickness, and lock type.
- Refer to Section B for Escutcheon Specifications.

	ACTIVE	DUMMY	ESCUTCHEON OPTIONS
A	  E210 E210	  E210 E210	A 2 1/4" x 8" Metro Escutcheon E210 / E210 Passage Spring Latch \$ 748 E210 / E210 Passage Mortise Lock \$ 992 E210 Single Dummy \$ 302 E210 / E210 Full Dummy \$ 604
B	  E206 E206	  E206 E206	B 2 1/4" x 10" Metro Escutcheon E206 / E206 Passage Spring Latch \$ 843 E206 / E206 Passage Mortise Lock \$ 1,084 E206 Single Dummy \$ 349 E206 / E206 Full Dummy \$ 698
C	  E256 E256	  E256 E256	C 2 1/2" x 13" Metro Escutcheon E256 / E256 Passage Spring Latch \$ 876 E256 / E256 Passage Mortise Lock \$ 1,118 E256 Single Dummy \$ 367 E256 / E256 Full Dummy \$ 734
D	  E264 E264	  E264 E264	D 3 1/2" x 13" Metro Escutcheon E264 / E264 Passage Spring Latch \$ 941 E264 / E264 Passage Mortise Lock \$ 1,183 E264 Single Dummy \$ 399 E264 / E264 Full Dummy \$ 798

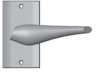
- Price includes your choice of handle except for the Crystal and Glass Knobs (K150, K151, K155, K156), where an upcharge applies. (Knobs not recommended for use with E10203 escutcheons.) Call RMH for pricing.
- Combinations are shown with L10302 Raleigh Lever for illustration purposes only. Refer to Section A for desired handle.
- Refer to website for door preparatory specifications. Call RMH to verify compatibility of each escutcheon with pre-existing door conditions.
- These escutcheons (E10203) are not compatible with a 2 1/8" face bore.
- Specify metal, patina, handing, backset, door thickness, and lock type.
- Refer to Section B for Escutcheon Specifications.

	ACTIVE	DUMMY	ESCUTCHEON OPTIONS
A	  E10155 E10155	  E10155 E10155	A 3" x 4 1/4" Oasis Escutcheon E10155 / E10155 Passage Spring Latch... \$ 651 E10155 / E10155 Passage Mortise Lock .. \$ 893 E10155 Single Dummy \$ 253 E10155 / E10155 Full Dummy \$ 506
B	  E10203 E10203	  E10203 E10203	B 2 1/2" x 2 1/2" Square Oasis Escutcheon E10203 / E10203 Passage Spring Latch . \$ 635 E10203 / E10203 Passage Mortise Lock . \$ 876 E10203 Single Dummy \$ 246 E10203 / E10203 Full Dummy \$ 492
C	  E10205 E10205	  E10205 E10205	C 2 1/2" x 4 1/2" Oasis Escutcheon E10205 / E10205 Passage Spring Latch . \$ 651 E10205 / E10205 Passage Mortise Lock . \$ 893 E10205 Single Dummy \$ 253 E10205 / E10205 Full Dummy \$ 506

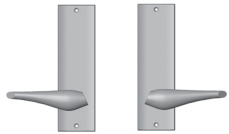
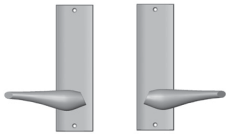



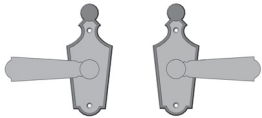
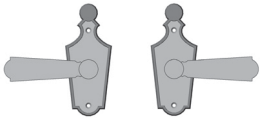
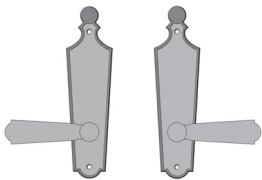
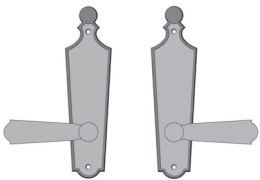

- Price includes your choice of handle except for the Crystal and Glass Knobs (K150, K151, K155, K156), where an upcharge applies. Call RMH for pricing.
- Combinations are shown with L10302 Raleigh Lever for illustration purposes only. Refer to Section A for desired handle.
- Refer to website for door preparatory specifications. Call RMH to verify compatibility of each escutcheon with pre-existing door conditions.
- Specify metal, patina, handing, backset, door thickness, and lock type.
- Refer to Section B for Escutcheon Specifications.

	ACTIVE	DUMMY	ESCUTCHEON OPTIONS
A	 E10208 E10208	 E10208 E10208	A 2 1/2" x 8 1/2" Oasis Escutcheon E10208 / E10208 Passage Spring Latch . . \$ 748 E10208 / E10208 Passage Mortise Lock . . \$ 992 E10208 Single Dummy \$ 302 E10208 / E10208 Full Dummy \$ 604
B	 E10216 E10216	 E10216 E10216	B 2 1/2" x 11" Oasis Escutcheon E10216 / E10216 Passage Spring Latch . . . \$ 843 E10216 / E10216 Passage Mortise Lock . . . \$ 1,084 E10216 Single Dummy \$ 349 E10216 / E10216 Full Dummy \$ 698

- Price includes your choice of handle except for the Crystal and Glass Knobs (K150, K151, K155, K156), where an upcharge applies. Call RMH for pricing.
- Combinations are shown with L10010 Paris Lever for illustration purposes only. Refer to Section A for desired handle.
- Refer to website for door preparatory specifications. Call RMH to verify compatibility of each escutcheon with pre-existing door conditions.
- These escutcheons (E10010 and E10015) are not compatible with a 2 1/8" face bore.
- Specify metal, patina, handing, backset, door thickness, and lock type.
- Refer to Section B for Escutcheon Specifications.

ACTIVE	DUMMY	ESCUTCHEON OPTIONS
<p>A</p>  <p>E10010 E10010</p>	<p>DUMMY</p>  <p>E10010 E10010</p>	<p>A 2 1/2" x 6" Paris Escutcheon Roger Thomas Collection E10010 / E10010 Passage Spring Latch\$ 821 E10010 / E10010 Passage Mortise Lock\$ 1,085 E10010 Single Dummy.....\$ 333 E10010 / E10010 Full Dummy\$ 666</p>
<p>B</p>  <p>E10015 E10015</p>	<p>DUMMY</p>  <p>E10015 E10015</p>	<p>B 2 1/2" x 9 1/4" Paris Escutcheon Roger Thomas Collection E10015 / E10015 Passage Spring Latch.....\$ 924 E10015 / E10015 Passage Mortise Lock\$ 1,185 E10015 Single Dummy.....\$ 384 E10015 / E10015 Full Dummy\$ 768</p>



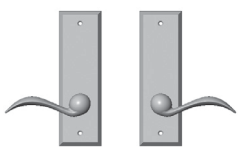
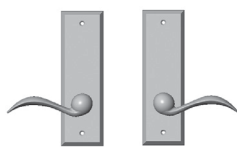



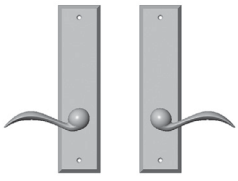
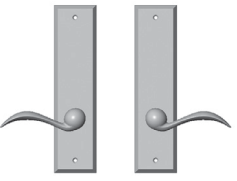
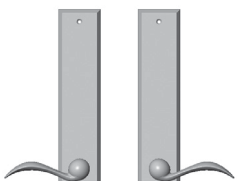
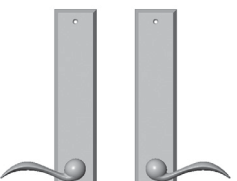
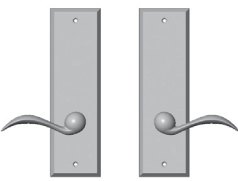
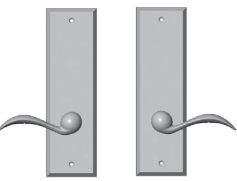
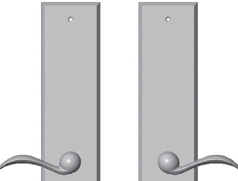
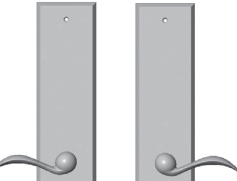

- Price includes your choice of handle except for the Crystal and Glass Knobs (K150, K151, K155, K156), where an upcharge applies. (Knobs not recommended for use with E415 and E416 escutcheons.) Call RMH for pricing.
- Combinations are shown with L105 Beaver Tail Lever for illustration purposes only. Refer to Section A for desired handle.
- Refer to website for door preparatory specifications. Call RMH to verify compatibility of each escutcheon with pre-existing door conditions.
- These escutcheons (E415 and E416) are not compatible with a 2 1/8" face bore.
- Specify metal, patina, handing, backset, door thickness, and lock type.
- Refer to Section B for Escutcheon Specifications.

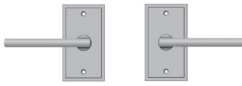
	ACTIVE	DUMMY	ESCUTCHEON OPTIONS
A	 E416 E416	 E416 E416	A 2 5/8" x 2 5/8" Square Escutcheon E416 / E416 Passage Spring Latch \$ 635 E416 / E416 Passage Mortise Lock \$ 876 E416 Single Dummy \$ 246 E416 / E416 Full Dummy \$ 492
B	 E415 E415	 E415 E415	B 3 9/16" x 3 9/16" Diamond Escutcheon E415 / E415 Passage Spring Latch \$ 635 E415 / E415 Passage Mortise Lock \$ 876 E415 Single Dummy \$ 246 E415 / E415 Full Dummy \$ 492
C	 E414 E414	 E414 E414	C 2 1/2" x 4 1/2" Rectangular Escutcheon E414 / E414 Passage Spring Latch \$ 651 E414 / E414 Passage Mortise Lock \$ 893 E414 Single Dummy \$ 253 E414 / E414 Full Dummy \$ 506
D	 E410 E410	 E410 E410	D 2 1/2" x 8" Rectangular Escutcheon E410 / E410 Passage Spring Latch \$ 748 E410 / E410 Passage Mortise Lock \$ 992 E410 Single Dummy \$ 302 E410 / E410 Full Dummy \$ 604







- Price includes your choice of handle except for the Crystal and Glass Knobs (K150, K151, K155, K156), where an upcharge applies. Call RMH for pricing.
- Combinations are shown with L105 Beaver Tail Lever for illustration purposes only. Refer to Section A for desired handle.
- Refer to website for door preparatory specifications. Call RMH to verify compatibility of each escutcheon with pre-existing door conditions.
- Specify metal, patina, handing, backset, door thickness, and lock type.
- Refer to Section B for Escutcheon Specifications.

	ACTIVE	DUMMY	ESCUTCHEON OPTIONS
A	 E408 E408	 E408 E408	A 2 1/2" x 10" Rectangular Escutcheon E408 / E408 Passage Spring Latch . . . \$ 843 E408 / E408 Passage Mortise Lock . . . \$ 1,084 E408 Single Dummy \$ 349 E408 / E408 Full Dummy \$ 698
B	 E436 E436	 E436 E436	B 2 1/2" x 13" Rectangular Escutcheon E436 / E436 Passage Spring Latch . . . \$ 876 E436 / E436 Passage Mortise Lock . . . \$ 1,118 E436 Single Dummy \$ 367 E436 / E436 Full Dummy \$ 734
C	 E404 E404	 E404 E404	C 3" x 10" Rectangular Escutcheon E404 / E404 Passage Spring Latch . . . \$ 843 E404 / E404 Passage Mortise Lock . . . \$ 1,084 E404 Single Dummy \$ 349 E404 / E404 Full Dummy \$ 698
D	 E460 E460	 E460 E460	D 3 1/2" x 13" Rectangular Escutcheon E460 / E460 Passage Spring Latch . . . \$ 941 E460 / E460 Passage Mortise Lock . . . \$ 1,183 E460 Single Dummy \$ 399 E460 / E460 Full Dummy \$ 798

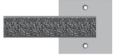

- Price includes your choice of handle except for the Crystal and Glass Knobs (K150, K151, K155, K156), where an upcharge applies. Call RMH for pricing.
- Combinations are shown with L135 Olympus Lever for illustration purposes only. Refer to Section A for desired handle.
- Refer to website for door preparatory specifications. Call RMH to verify compatibility of each escutcheon with pre-existing door conditions.
- Specify metal, patina, handing, backset, door thickness, and lock type.
- Refer to Section B for Escutcheon Specifications.

	ACTIVE	DUMMY	ESCUTCHEON OPTIONS
A	 E304 E304	 E304 E304	A 2 1/2" x 4 1/2" Stepped Escutcheon E304 / E304 Passage Spring Latch . . . \$ 651 E304 / E304 Passage Mortise Lock . . . \$ 893 E304 Single Dummy \$ 253 E304 / E304 Full Dummy \$ 506
B	 E308 E308	 E308 E308	B 2 1/2" x 8" Stepped Escutcheon E308 / E308 Passage Spring Latch . . . \$ 748 E308 / E308 Passage Mortise Lock . . . \$ 992 E308 Single Dummy \$ 302 E308 / E308 Full Dummy \$ 604
C	 E312 E312	 E312 E312	C 2 1/2" x 11" Stepped Escutcheon E312 / E312 Passage Spring Latch . . . \$ 843 E312 / E312 Passage Mortise Lock . . . \$ 1,084 E312 Single Dummy \$ 349 E312 / E312 Full Dummy \$ 698
D	 E356 E356	 E356 E356	D 2 1/2" x 13" Stepped Escutcheon E356 / E356 Passage Spring Latch . . . \$ 876 E356 / E356 Passage Mortise Lock . . . \$ 1,118 E356 Single Dummy \$ 367 E356 / E356 Full Dummy \$ 734
E	 E360 E360	 E360 E360	E 3 1/2" x 13" Stepped Escutcheon E360 / E360 Passage Spring Latch . . . \$ 941 E360 / E360 Passage Mortise Lock . . . \$ 1,183 E360 Single Dummy \$ 399 E360 / E360 Full Dummy \$ 798

- Price includes your choice of handle except for the Crystal and Glass Knobs (K150, K151, K155, K156), where an upcharge applies. (Knobs not recommended for use with E30303 escutcheon.) Call RMH for pricing.
- Combinations are shown with L30301 Trousdale Lever for illustration purposes only. Refer to Section A for desired handle.
- Refer to website for door preparatory specifications. Call RMH to verify compatibility of each escutcheon with pre-existing door conditions.
- This escutcheon (E30303) is not compatible with 2 1/8" face bore.
- Specify metal, patina, handing, backset, door thickness, and lock type.
- Refer to Section B for Escutcheon Specifications.

	ACTIVE	DUMMY	ESCUTCHEON OPTIONS
A	 E30303	 E30303	A 3" Square Trousdale Escutcheon Kravitz Design Collection E30303 / E30303 Passage Spring Latch . \$ 905 E30303 / E30303 Passage Mortise Lock . \$ 1,149 E30303 Single Dummy \$ 381 E30303 / E30303 Full Dummy \$ 762
B	 E30305	 E30305	
C	 E30310	 E30310	

- Combinations are shown with L10501 Verdura Lever. Combinations only available with L10501 or L10502 lever options. See section A for details.
- Refer to website for door preparatory specifications. Call RMH to verify compatibility of each escutcheon with pre-existing door conditions.
- These escutcheons (E10520) are not compatible with 2 1/8" face bore.
- Specify metal, patina, handing, backset, door thickness, and lock type.
- Combinations available with concealed mount. See upcharge below.
- Refer to Section B for Escutcheon Specifications.

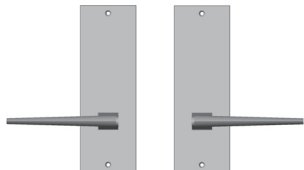
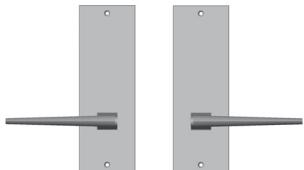
	ACTIVE	DUMMY	ESCUTCHEON OPTIONS
A	 E10520 E10520	 E10520 E10520	A 3" x 3" Square Verdura Escutcheon E10520 / E10520 Passage Spring Latch ... \$ 823 E10520 / E10520 Passage Mortise Lock ... \$ 1,043 E10520 Single Dummy \$ 347 E10520 / E10520 Full Dummy \$ 694 \$ 97 up-charge per set for concealed mount
B	 E10526 E10526	 E10526 E10526	B 3" x 9" Verdura Escutcheon E10526 / E10526 Passage Spring Latch... \$ 1,099 E10526 / E10526 Passage Mortise Lock ... \$ 1,317 E10526 Single Dummy \$ 487 E10526 / E10526 Full Dummy \$ 974 \$ 97 up-charge per set for concealed mount

