

L075 Ellis Lever

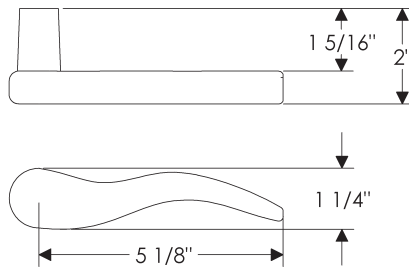

L101 Longhorn Lever

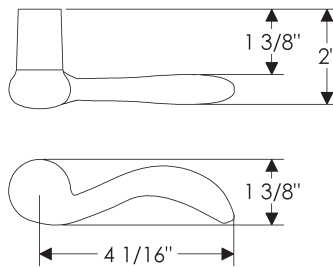

L102 Squirrel Tail Lever

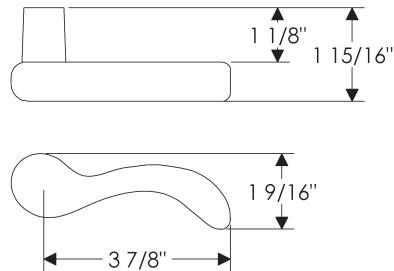

L103 Chub Lever
Also available:
L112 Large Chub Lever

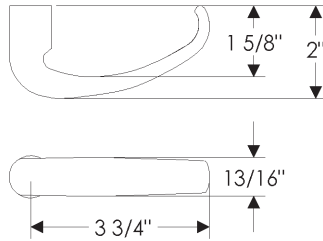

L104 Hook Lever
Also available:
L122 Large Hook Lever

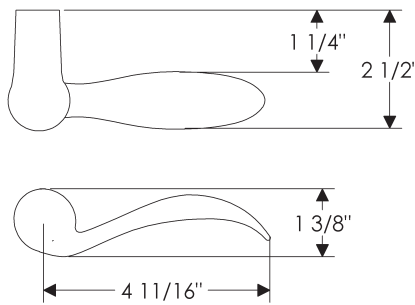

L105 Beaver Tail Lever

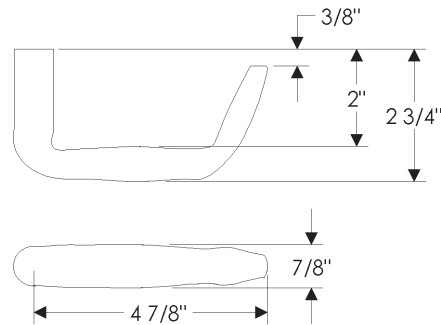
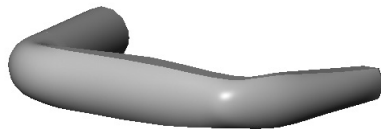

L106 Talon Lever

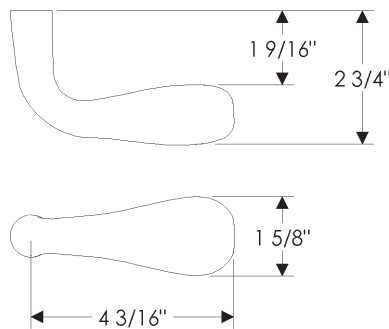
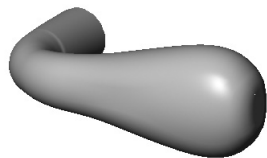

L107 Slugger Lever

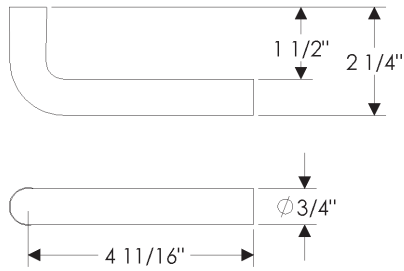
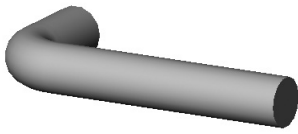

L108 Tube Lever

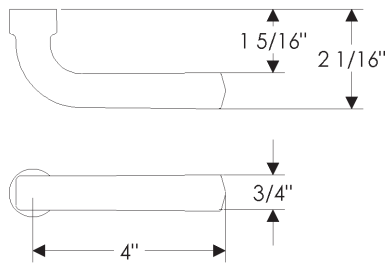
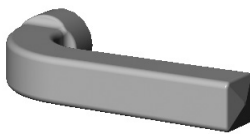

L109 Legacy Lever
Also available:
L119 Long Legacy Lever

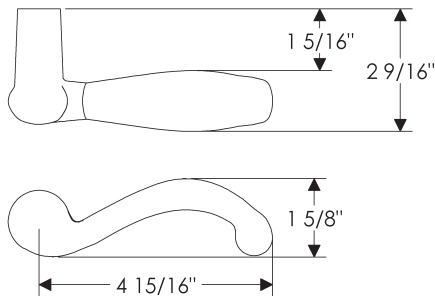

L110 Classic Lever
Also available:
L128 Small Classic Lever

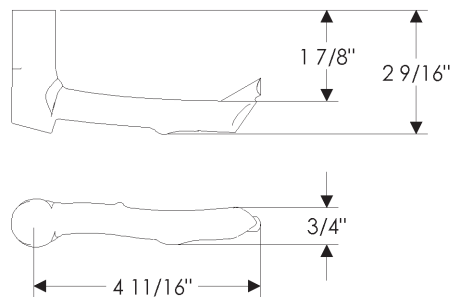
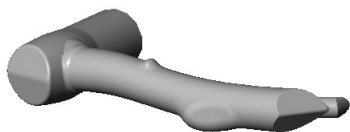

L111 Twig Lever

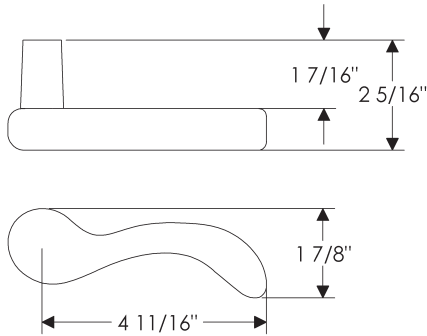
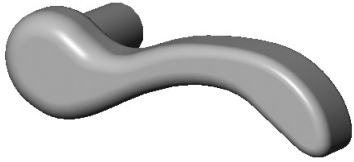

L112 Large Chub Lever
Also available:
L103 Chub Lever

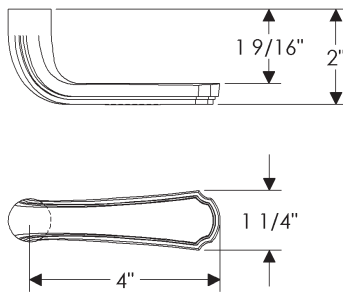
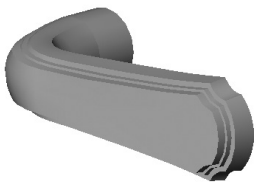

L113 Carriage Lever

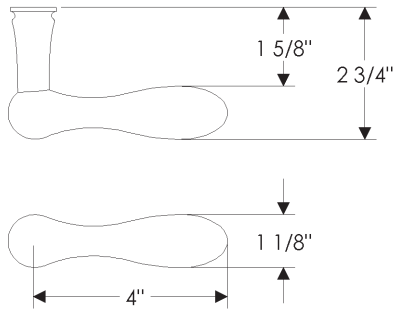
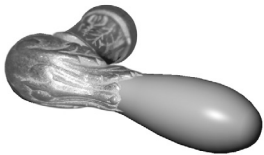

L115 Acanthus Lever
Also available:
L158 Large Acanthus Lever

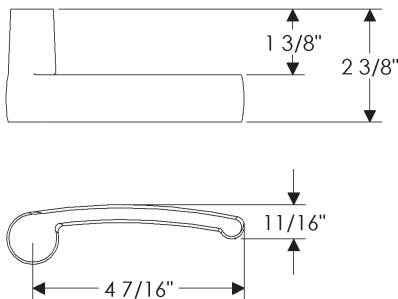
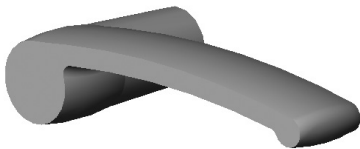

L116 Herron Lever

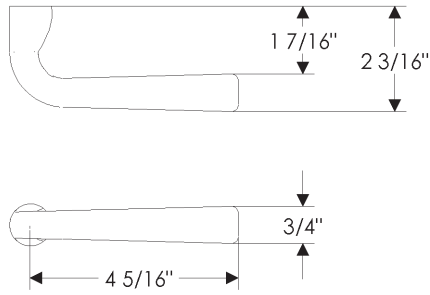
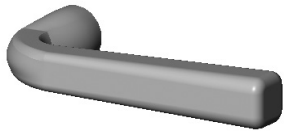

L117 French Lever
 Also available:
 L120 Long French Lever
 L241 Large French Lever

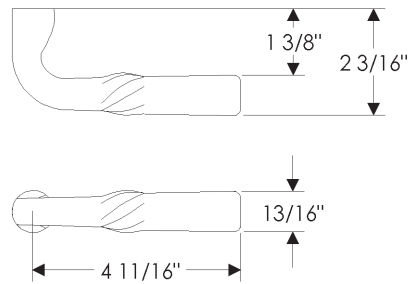
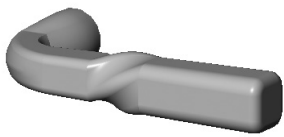

L118 French Twist Lever

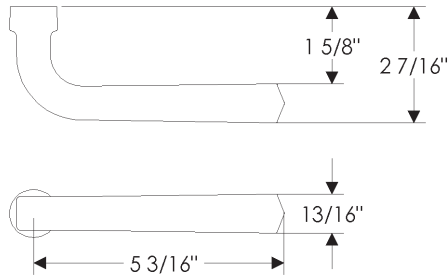
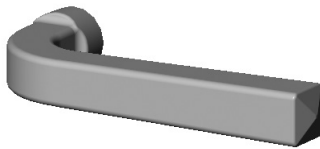

L119 Long Legacy Lever
 Also available:
 L109 Legacy Lever

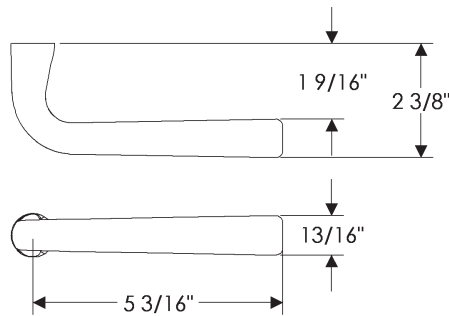
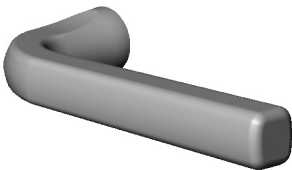

L120 Long French Lever
 Also available:
 L117 French Lever
 L241 Large French Lever

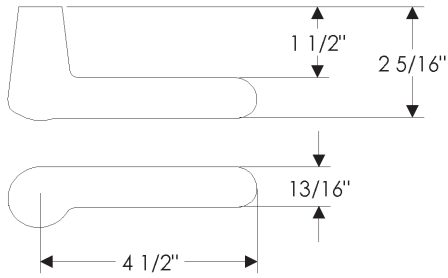
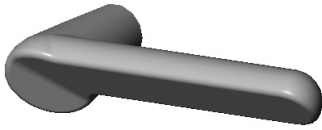

L121 Rock Creek Lever
Also available:
L141 Large Rock Creek Lever

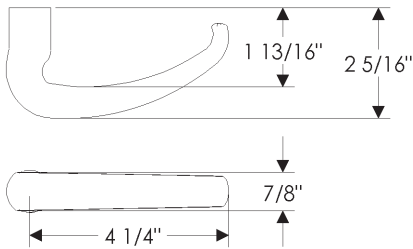
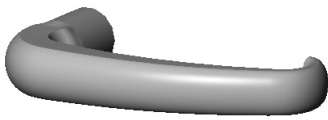

L122 Large Hook Lever
Also available:
L104 Hook Lever

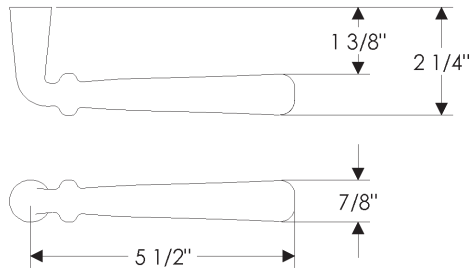
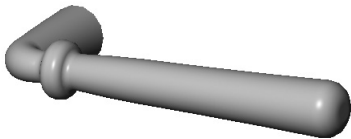

L123 Old World Lever

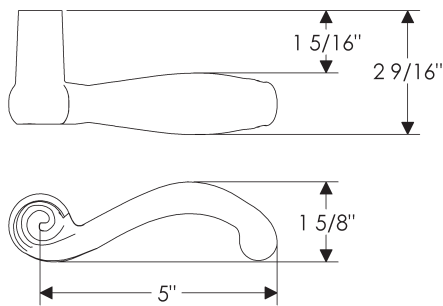

L125 Classic Scroll Lever

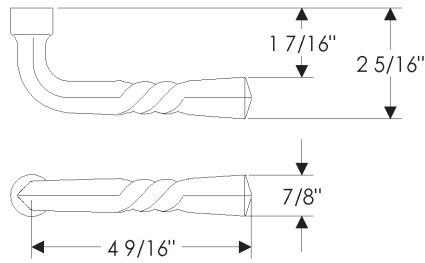
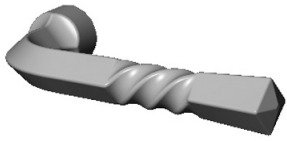

L126 Triple Twist Lever

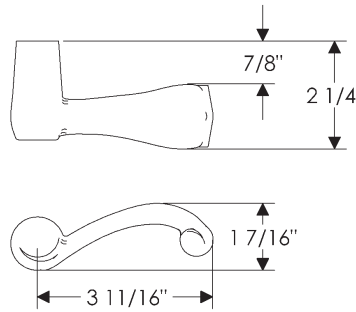

L127 Scroll Lever

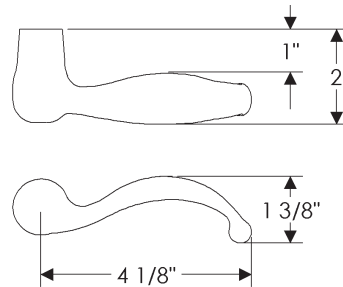

L128 Small Classic Lever
Also available:
L110 Classic Lever

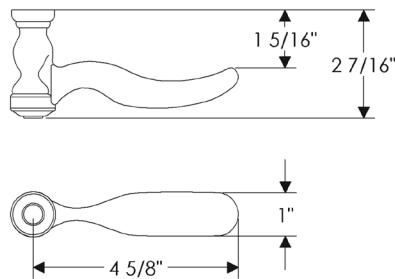
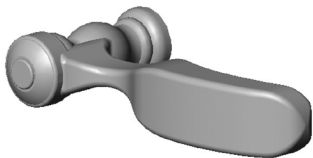

L129 Trundle Lever

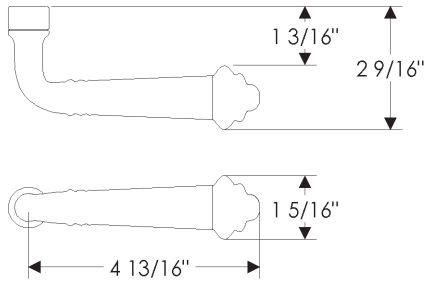
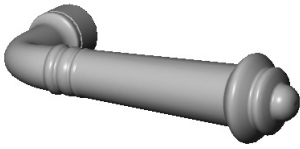

L130 Monarch Lever
Also available:
L131 Large Monarch Lever

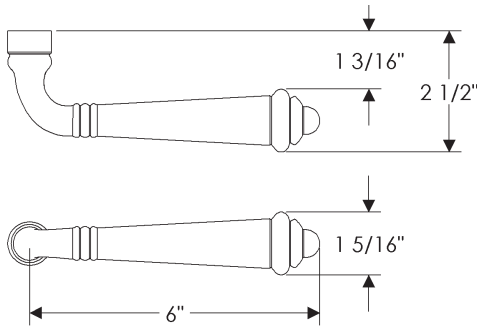
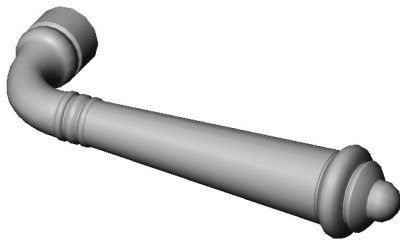

L131 Large Monarch Lever
Also available:
L130 Monarch Lever

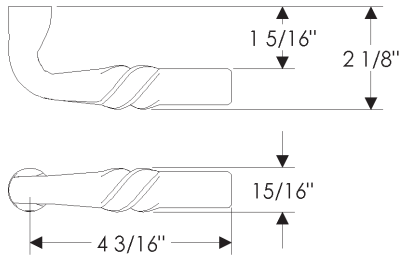
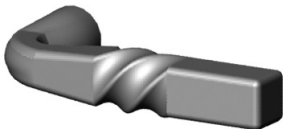

L132 Square Twist Lever

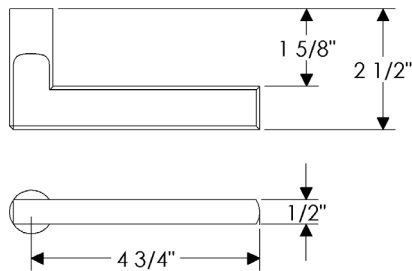
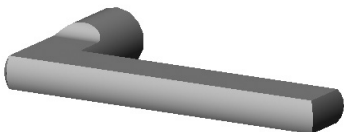

L135 Olympus Lever
Also available:
L147 Large Olympus Lever

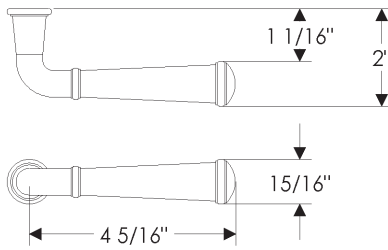
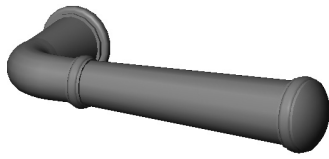

L140 Harrington Lever
Also available:
L151 Large Harrington Lever

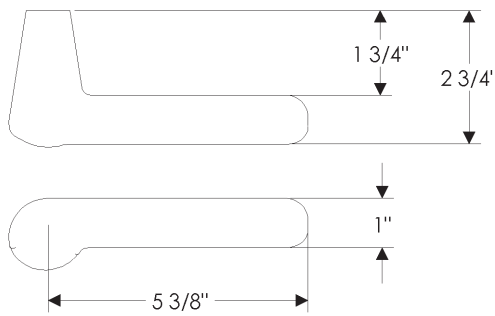
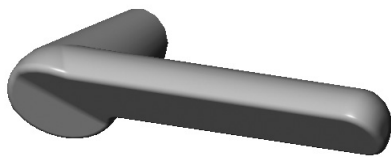

L141 Large Rock Creek Lever
Also available:
L121 Rock Creek Lever

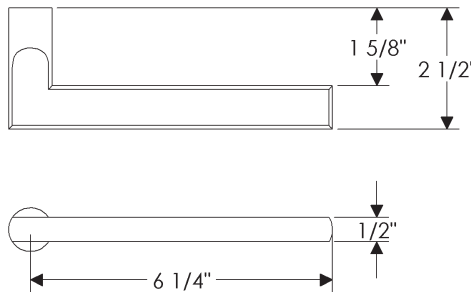
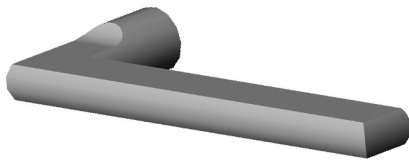

L147 Large Olympus Lever
Also available:
L135 Olympus Lever

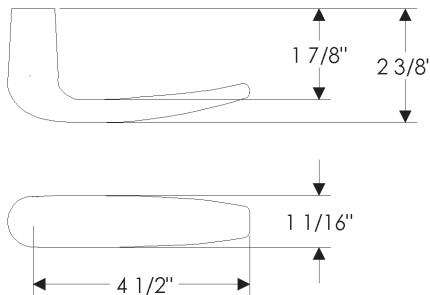
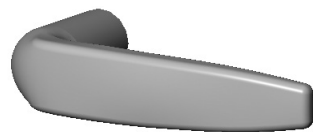

L150 Bella Lever

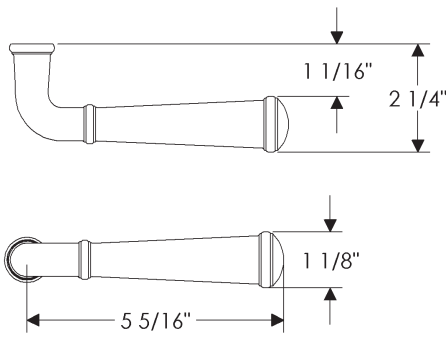
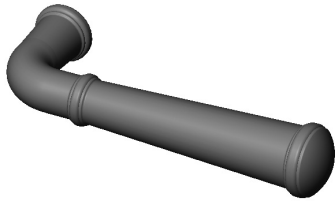

L151 Large Harrington Lever
Also available:
L140 Large Harrington Lever

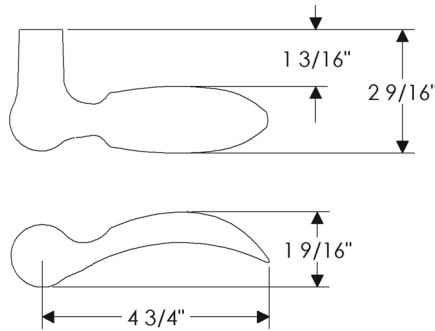
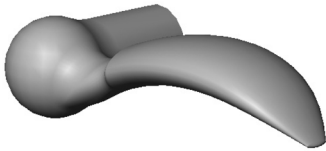

L152 Osprey Lever

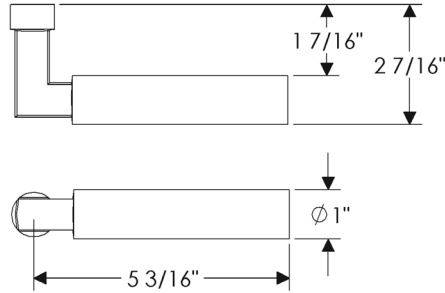
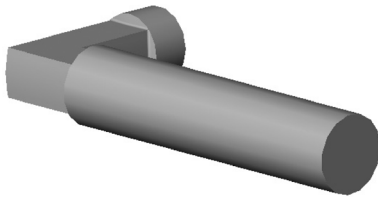

L154 Stalk Lever

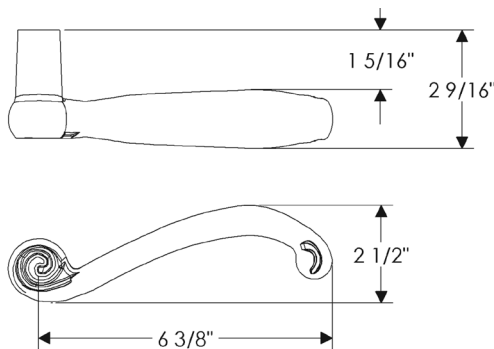

L156 Large Classic Scroll Lever
Also available:
L125 Classic Scroll Lever

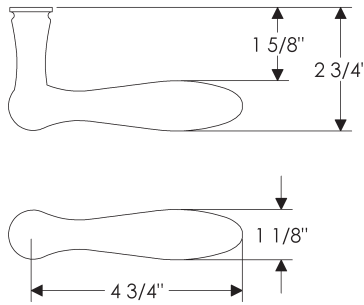
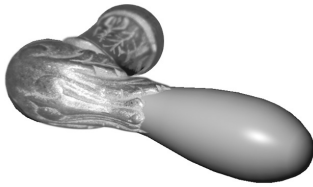

L158 Large Acanthus Lever
Also available:
L115 Acanthus Lever

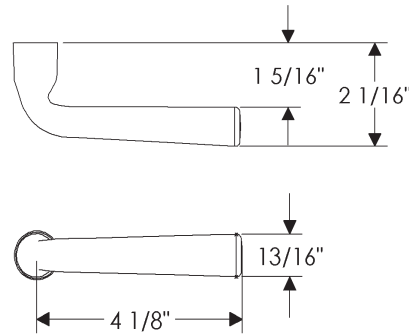
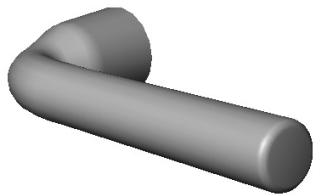

L159 Baton Lever

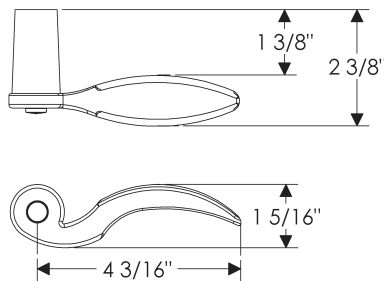

L160 Wing Lever

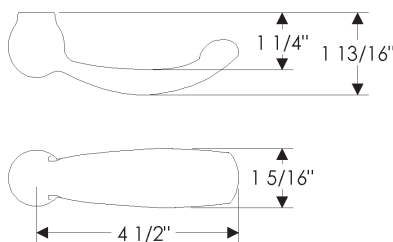
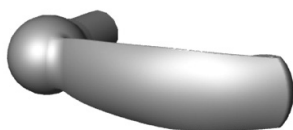

L163 Euro Lever

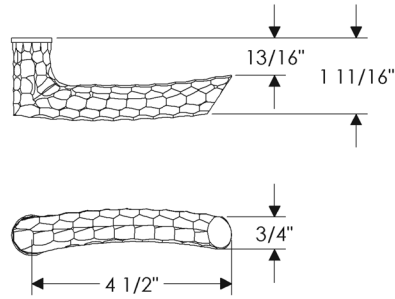
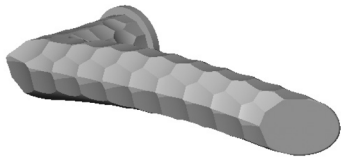

L164 Chiseled Lever
Roger Thomas Collection

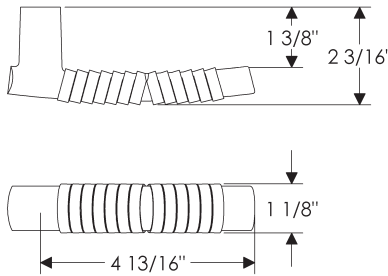
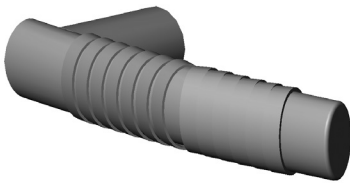

L174 Lariat Lever

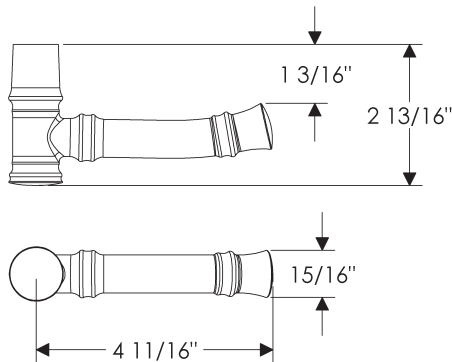
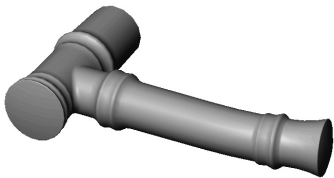

L175 Bamboo Lever

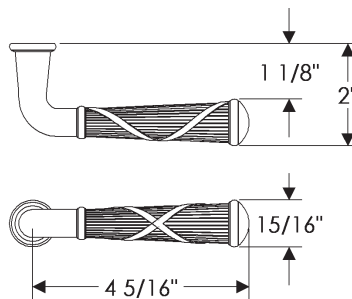
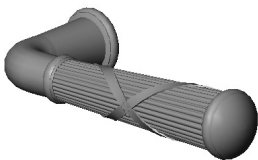

L182 Ribbon & Reed Lever

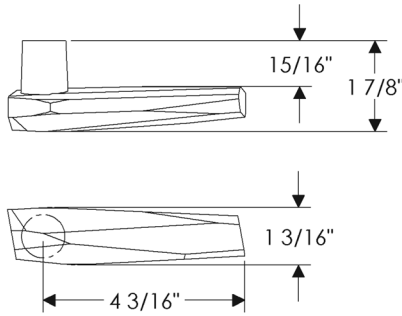
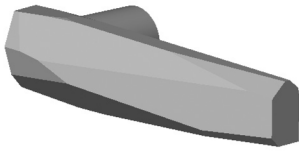

L185 Ore Lever

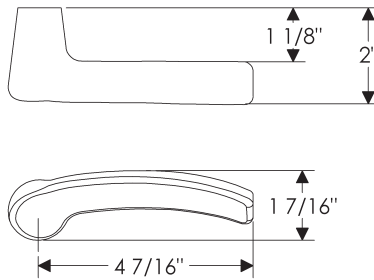

L224 Ridge Lever

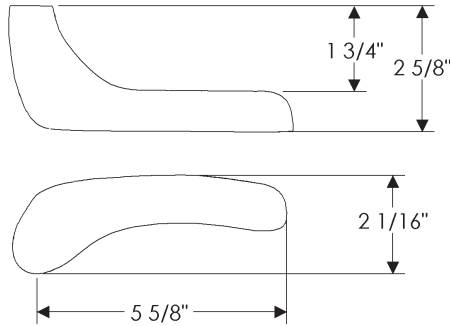

L228 Large Ridge Lever
• Note design style different from L224

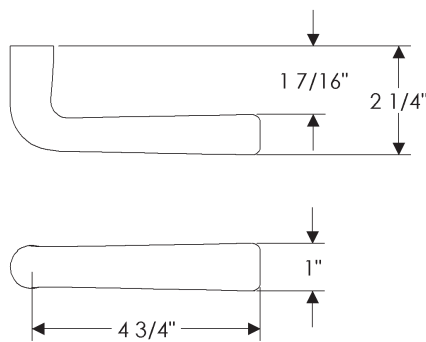
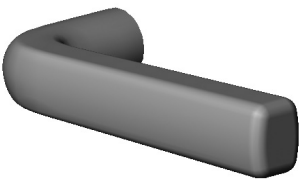

L241 Large French Lever
Also available:
L117 French Lever
L120 Long French Lever

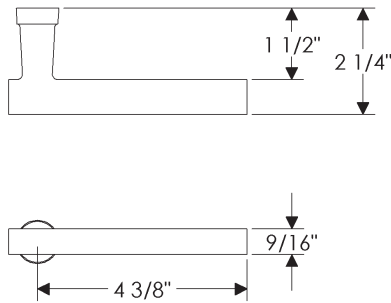
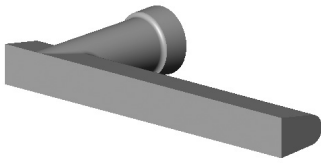

L260 Trolley Lever

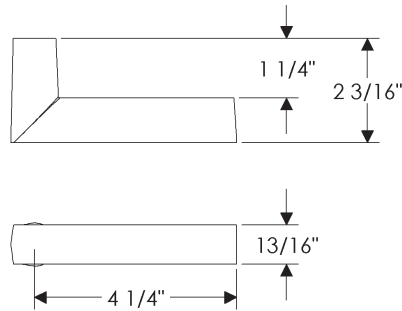
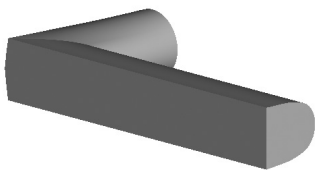

L261 Rail Lever

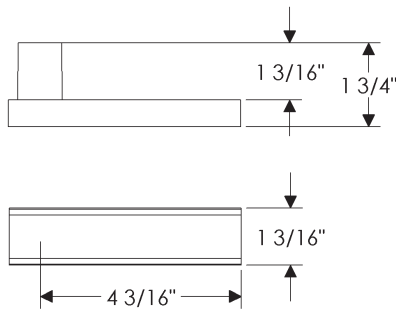
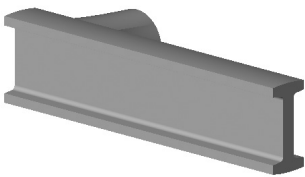

L265 I Beam Lever

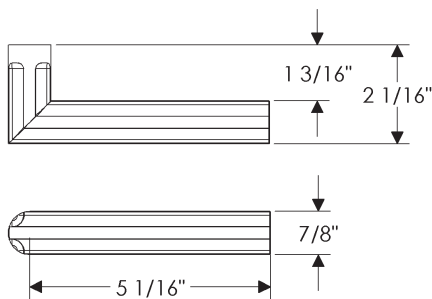
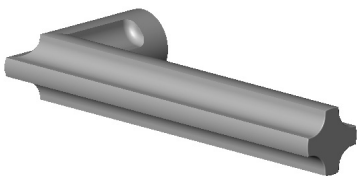

L267 Cross Lever

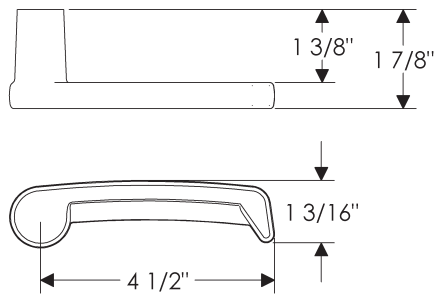
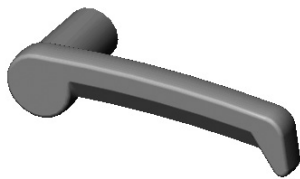

L276 Falcon Lever

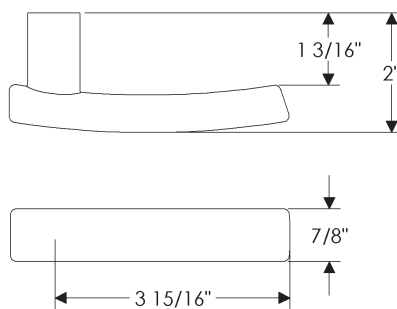
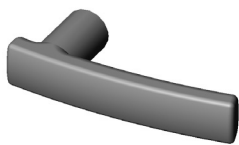

L301 Strap Lever
Also available:
L302 Large Strap Lever

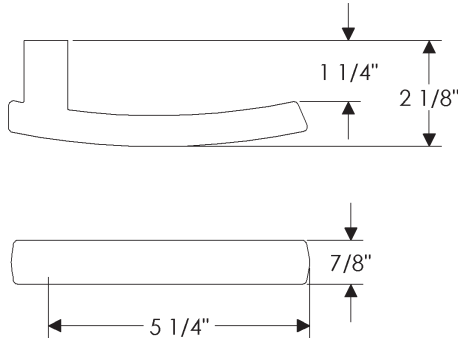
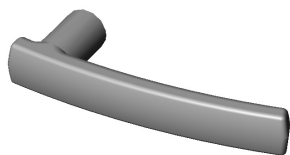

L302 Large Strap Lever
Also available:
L301 Strap Lever

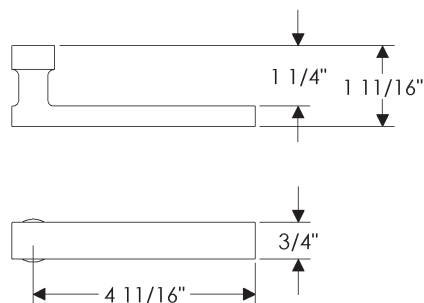
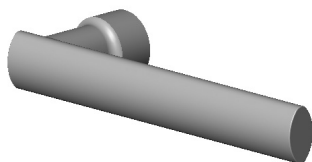

L303 Boiler Lever

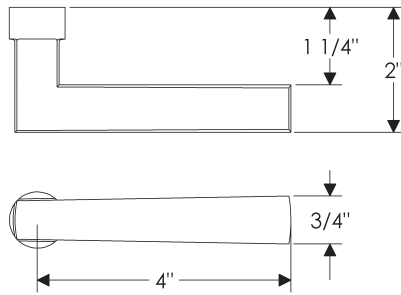
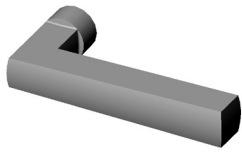

L304 Reed Lever

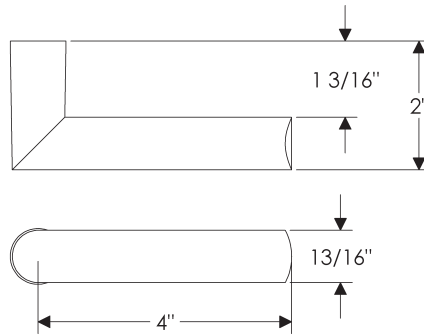
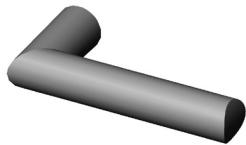

L307 Jane Lever
Also available:
L308 Long Jane Lever

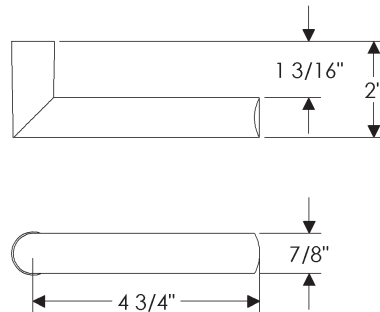
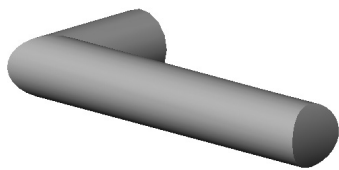

L308 Long Jane Lever
Also available:
L307 Jane Lever

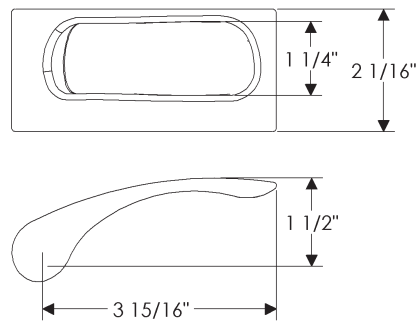

L310 Pool Lever

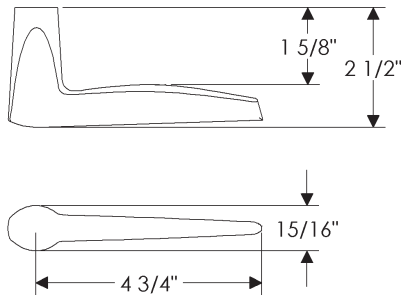
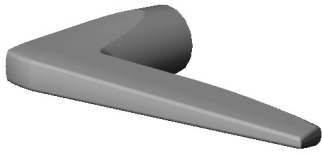

L311 Blade Lever

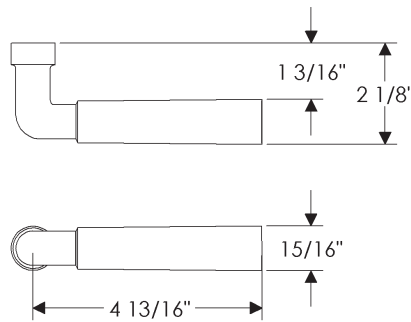
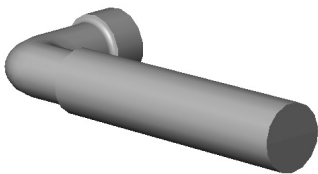

L330 Coupler Lever

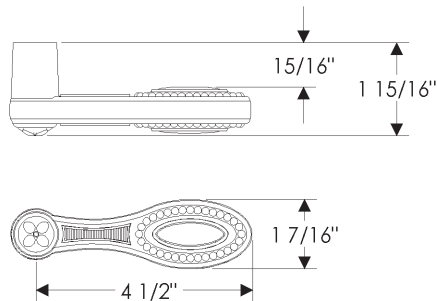
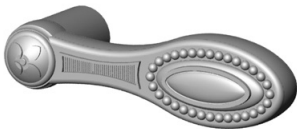

L580 Maddox Lever

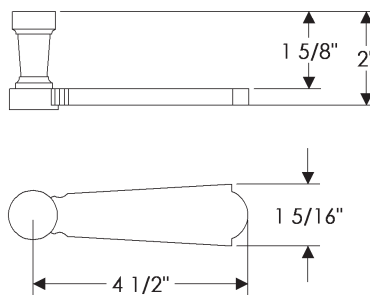
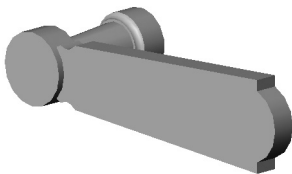

L10010 Paris Lever
Roger Thomas Collection

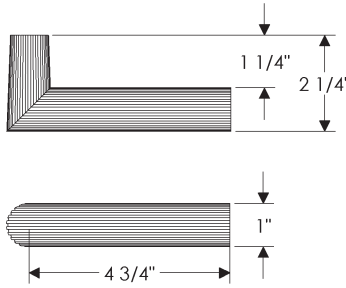
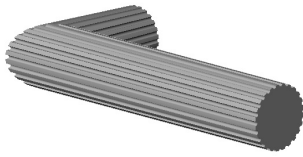

L10015 Flute Lever
Roger Thomas Collection

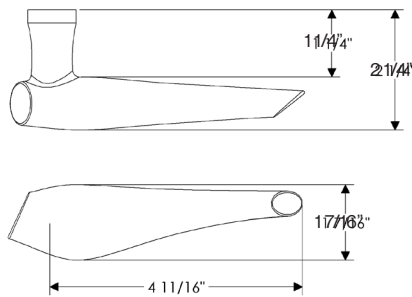
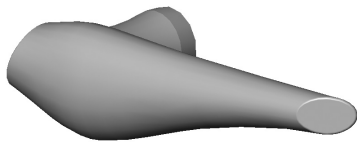

L10302 Raleigh Lever

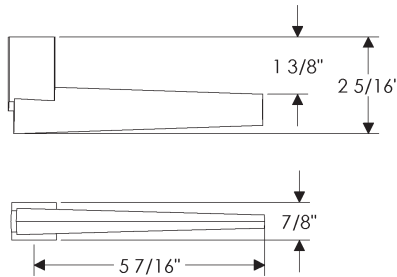
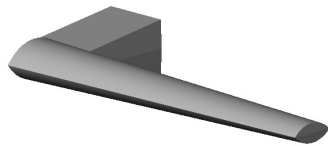

L10501 Verdura Leve
(only available with Verdura line)
• Not to be used with privacy spring latch sets.

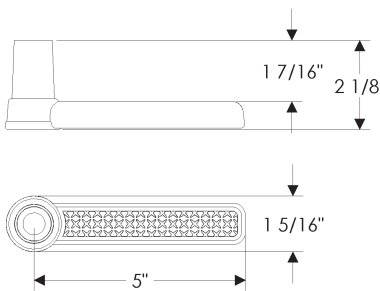
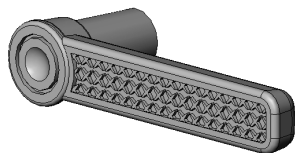

L10801 Briggs Lever

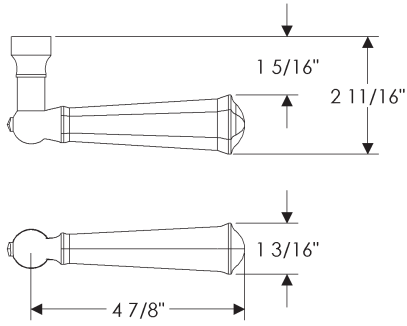
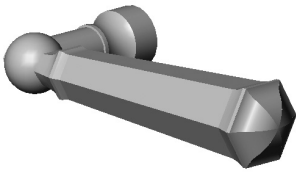

L10802 Kettle Lever

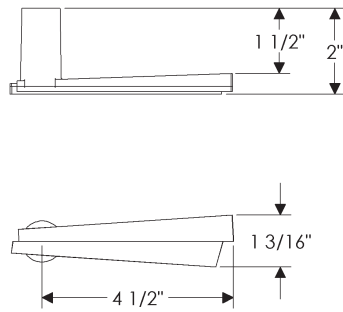
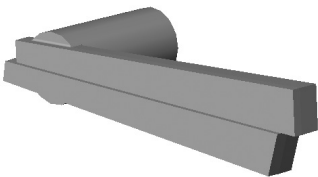

L20230 Shift Lever
Ted Boerner Collection

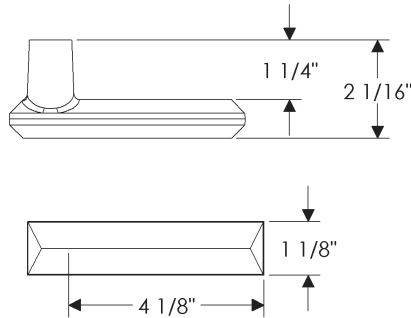
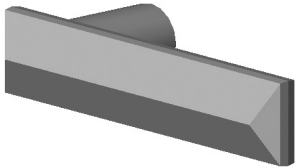

L21005 Emile Lever
Also available:
L21075 Large Emile Lever

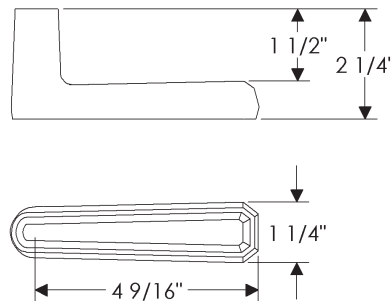
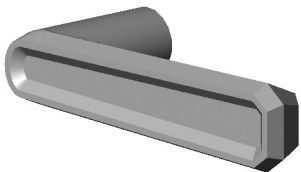

L30140 Smith Lever
Hammered texture

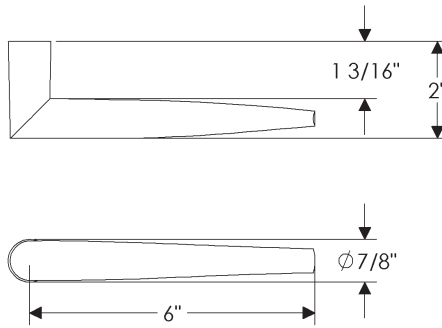
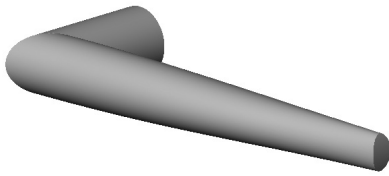

L30142 Whittle Lever
Hammered texture

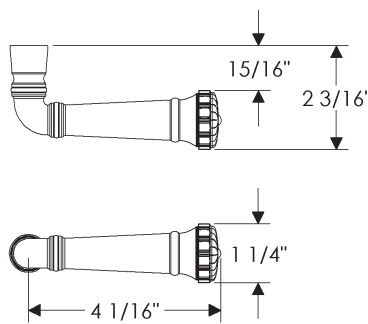
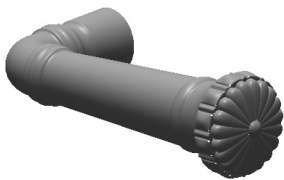

L30160 Crown Lever

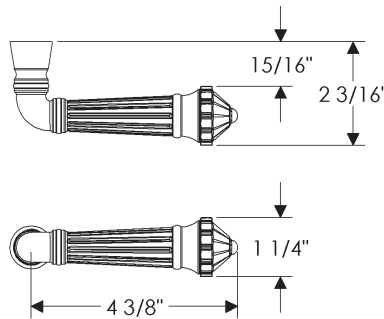
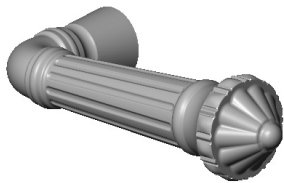

L30161 Capitol Lever

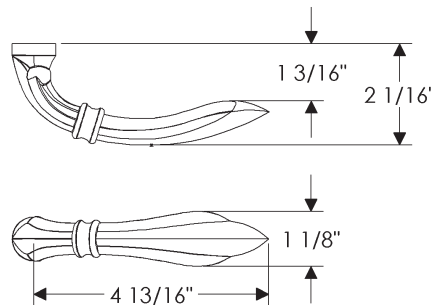
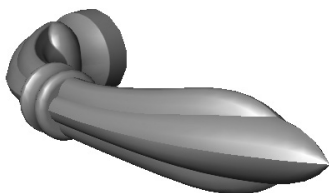

L30180 Chateau Lever

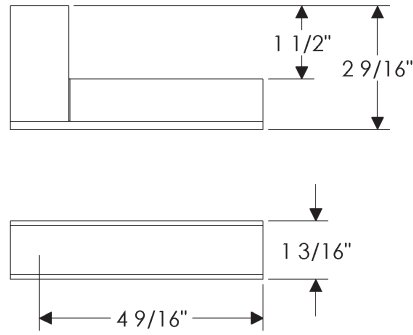
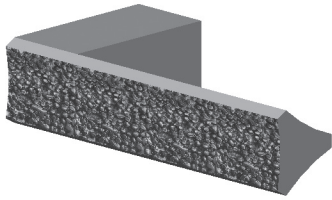

L30301 Trousdale Lever
Kravitz Design Collection
 Not to be used with privacy
 spring latch sets.

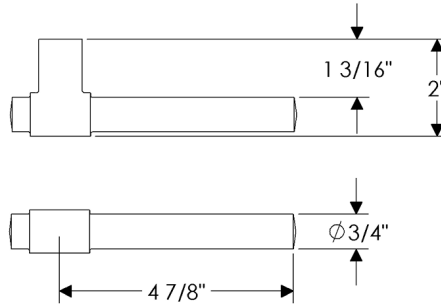
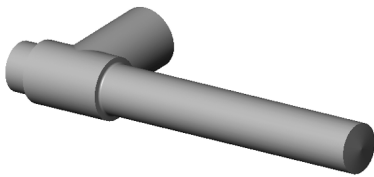

L10025 Barre Lever
Roger Thomas Collection

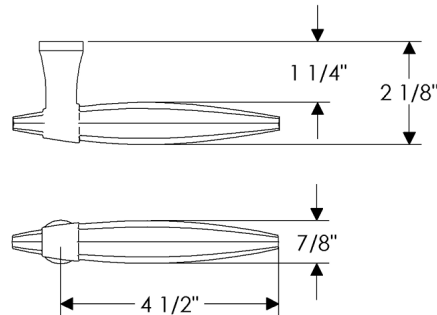
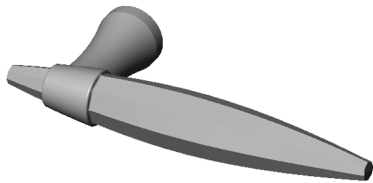

L10028 Zeppelin Lever
Roger Thomas Collection

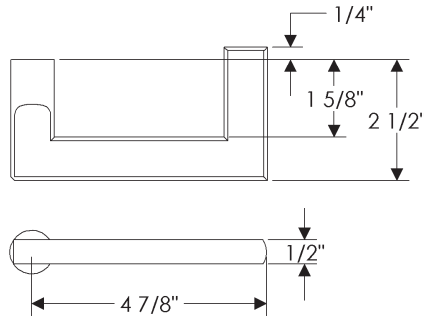
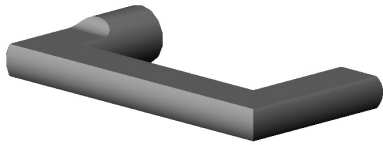

L137 Olympus Return Lever

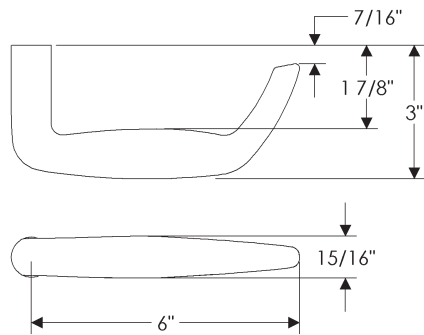

L153 Talon Return Lever

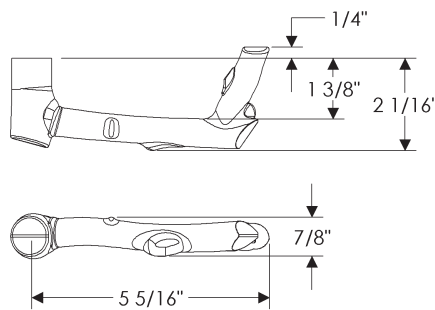
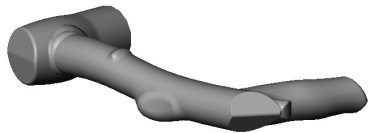

L179 Twig Return Lever

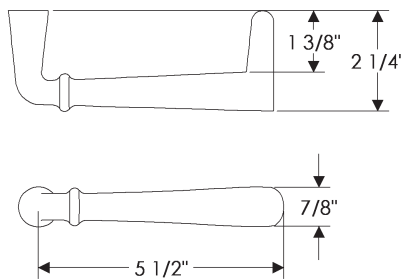
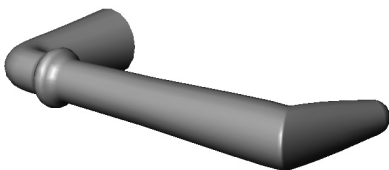

L216 Old World Return Lever

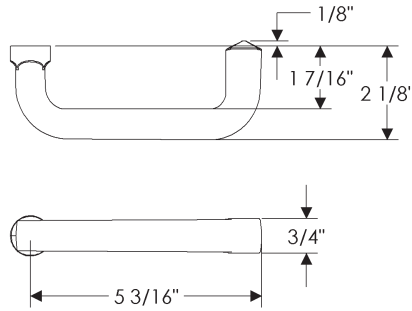

L219 Long Legacy Return Lever

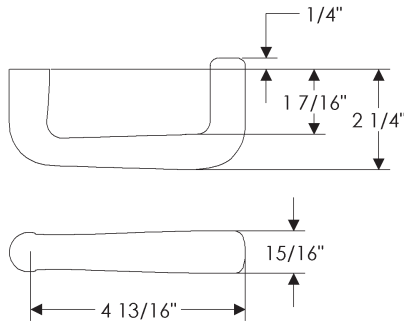
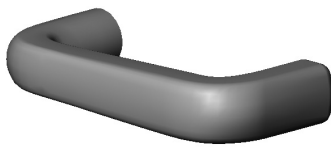

L245 French Return Lever

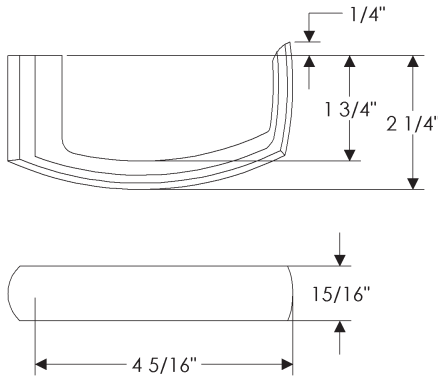
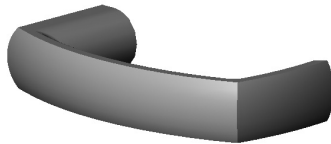

L314 UJ Return Lever

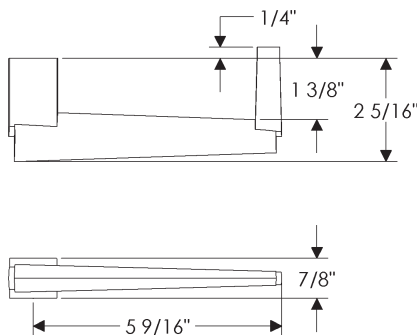
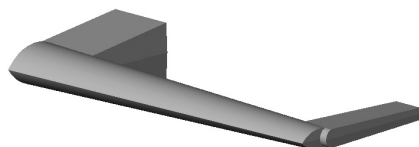

L10502 Verdura Return Lever
(only available with Verdura line)

Not to be used with privacy
spring latch sets.

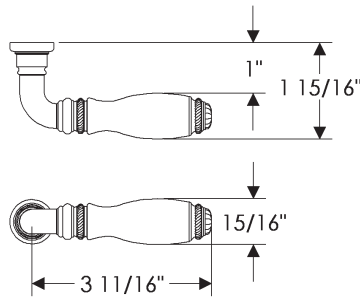

LW05 Mini Ellis Lever
Designed for WN window trim sets

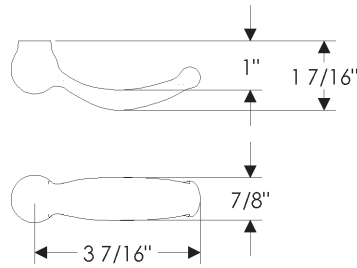

LW10 Mini Euro Lever
Designed for WN window trim sets

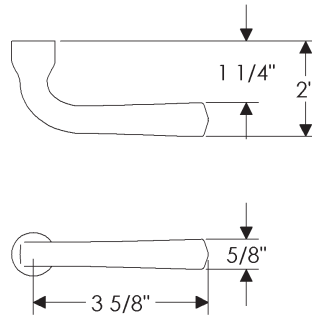
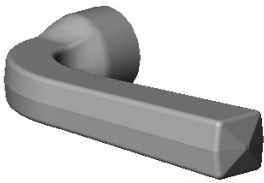

LW15 Mini Legacy Lever
Designed for WN window trim sets

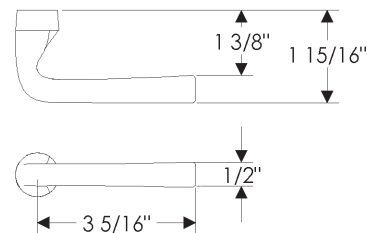
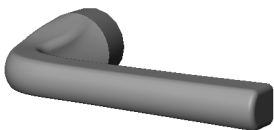

LW20 Mini French Lever
Designed for WN window trim sets

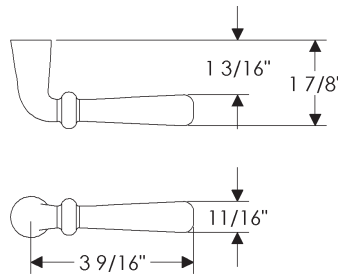
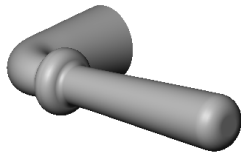

LW23 Mini Old World Lever
Designed for WN window trim sets

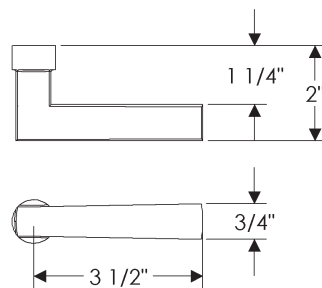
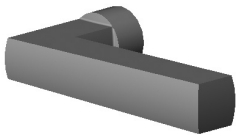

LW33 Mini Reed Lever
Designed for WN window trim sets

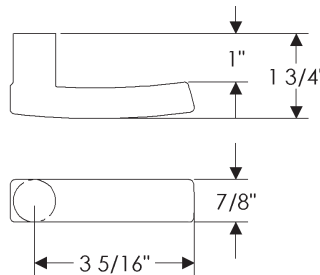
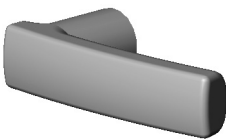

LW37 Mini Strap Lever
Designed for WN window trim sets

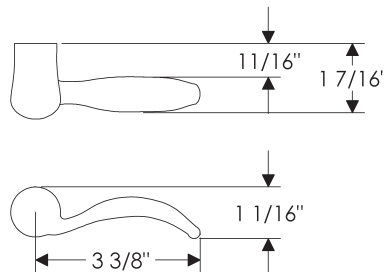

LW40 Mini Classic Lever
Designed for WN window trim sets

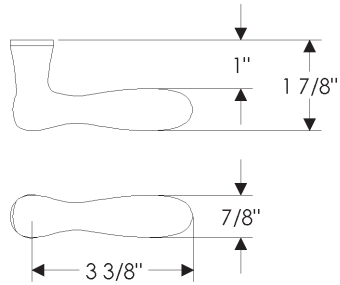

LW50 Mini Acanthus Lever
Designed for WN window trim sets

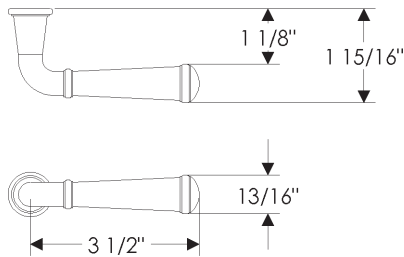
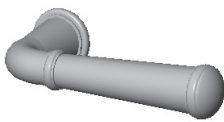

LW60 Mini Harrington Lever
• Designed for WN window trim sets

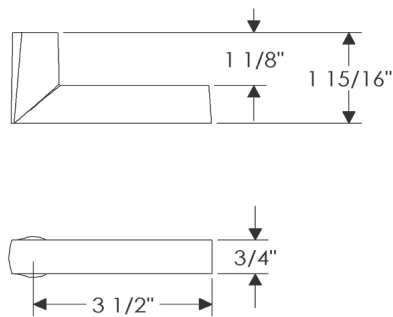
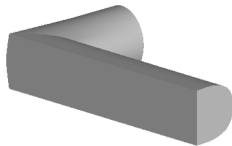

LW61 Mini Rail Lever
Designed for WN window trim sets

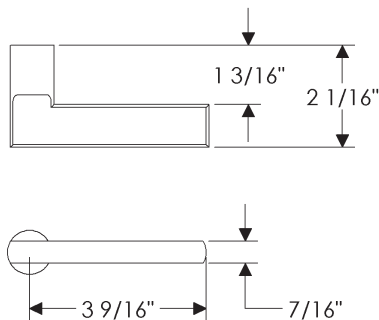
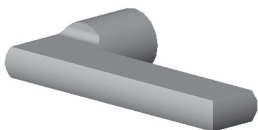

LW63 Mini Olympus Lever
Designed for WN window trim sets

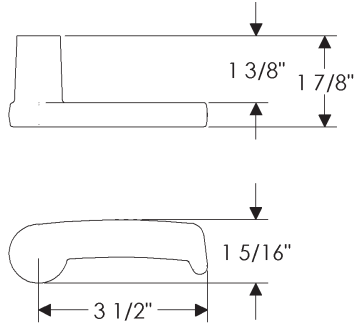
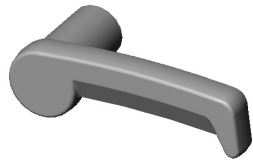

LW65 Mini Falcon Lever
Designed for WN window trim sets

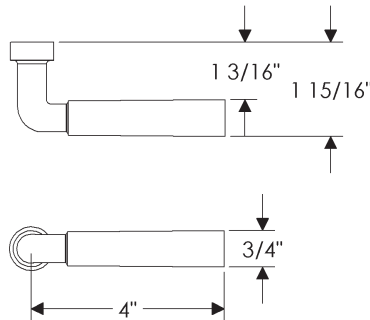
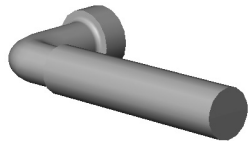

LW71 Mini Coupler Lever
Designed for WN window trim sets

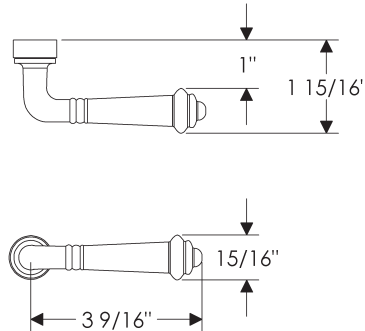
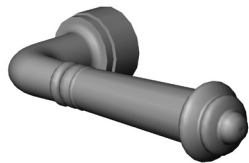

LW80 Mini Monarch Lever
Designed for WN window trim sets

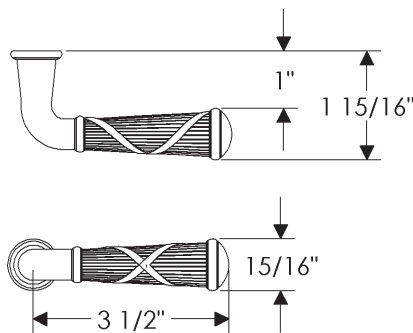
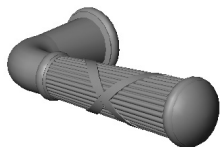

LW85 Mini Ribbon & Reed Lever
Designed for WN window trim sets

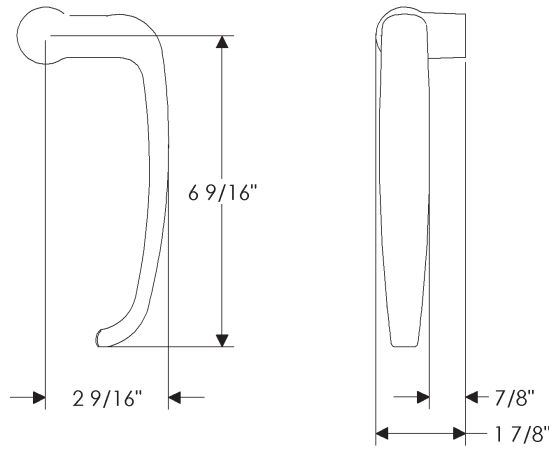

L124 Offset Lever

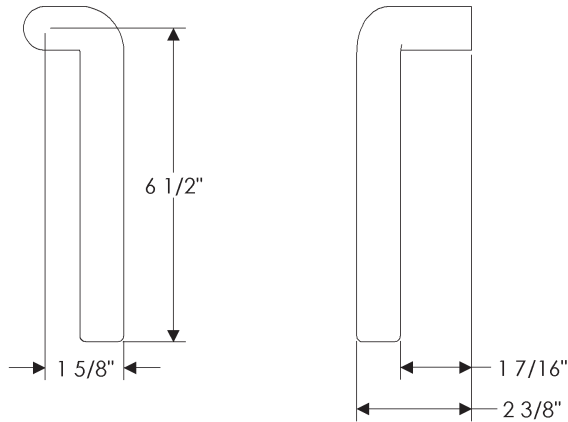
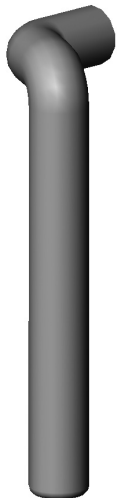

L177 Offset Tube Lever

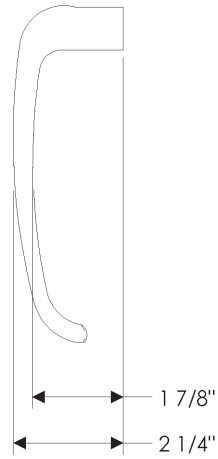
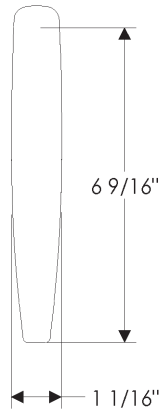

L114 Long Hook Lever

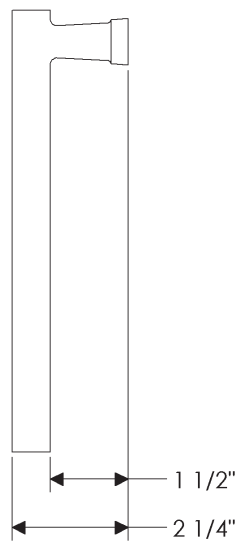
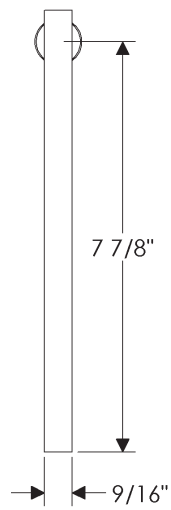
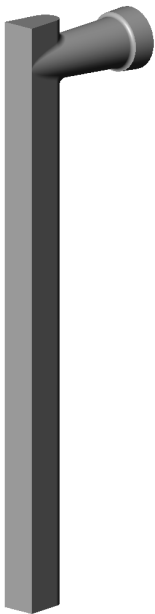

L264 Long Trolley Lever

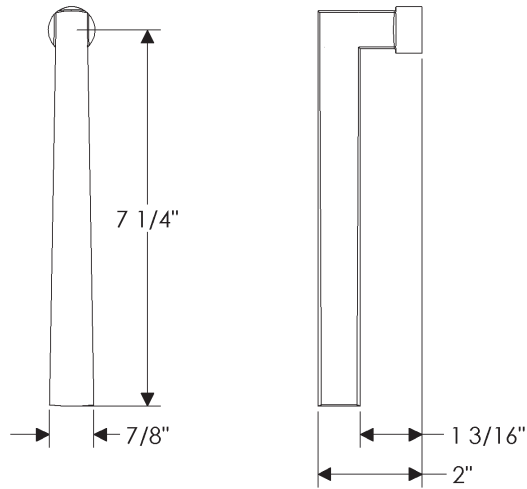
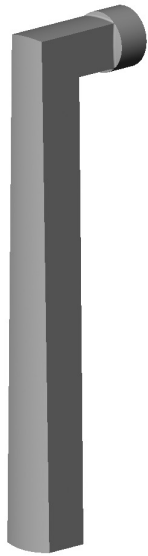

L134 Long Reed Lever

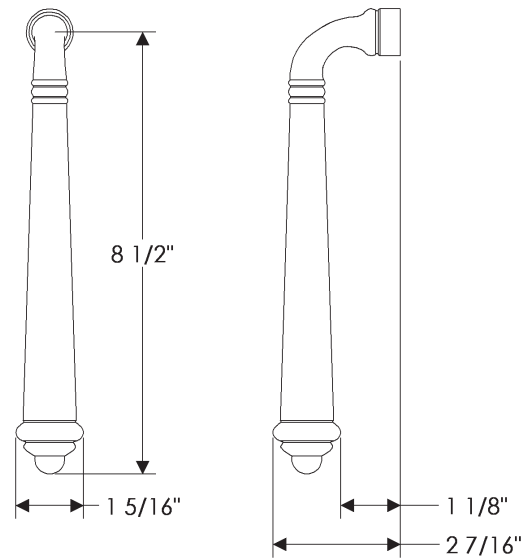
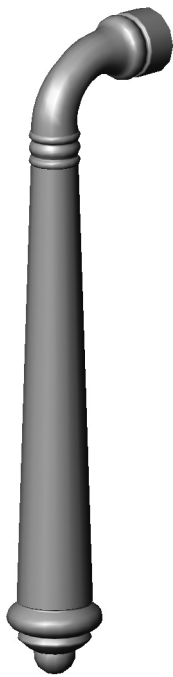

L138 Long Monarch Lever

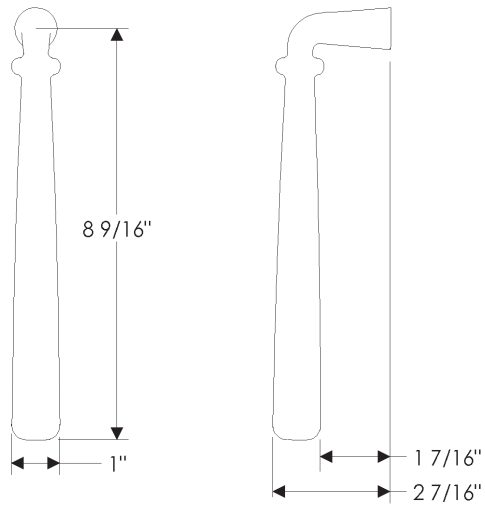

L139 Long Old World Lever

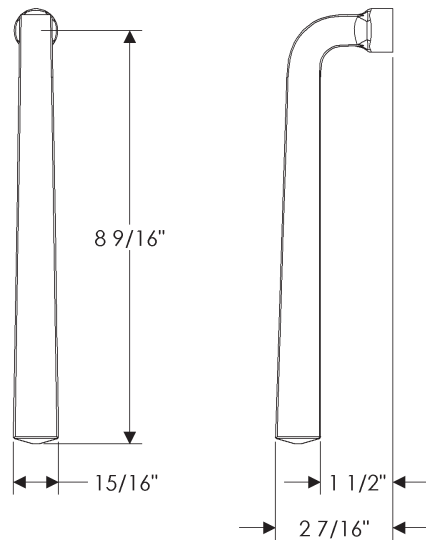
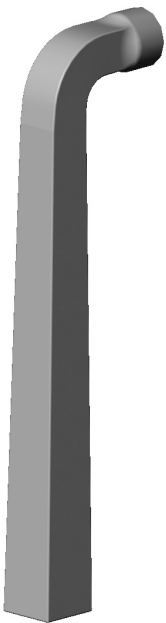

L142 Long Legacy Lever

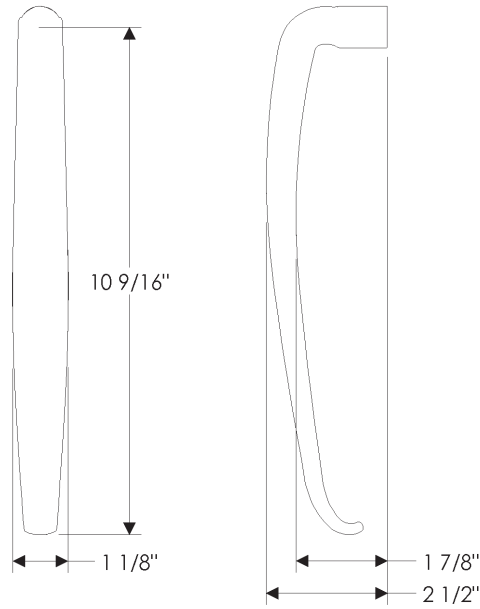

L144 Extra Long Hook Lever

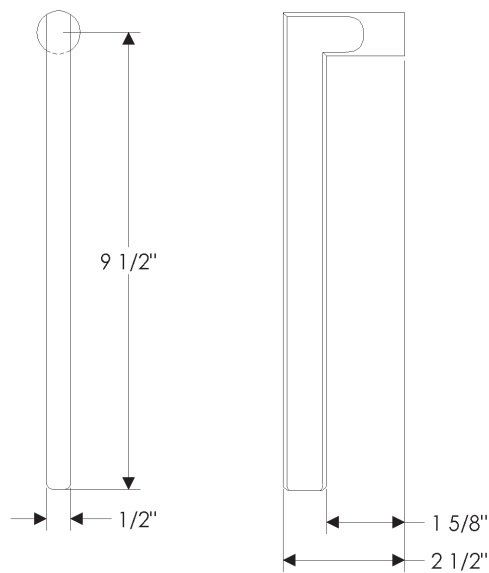
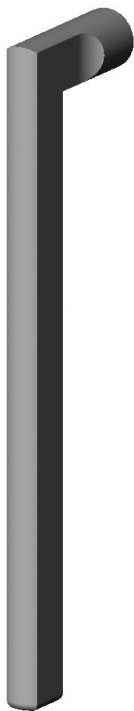

L145 Long Olympus Lever

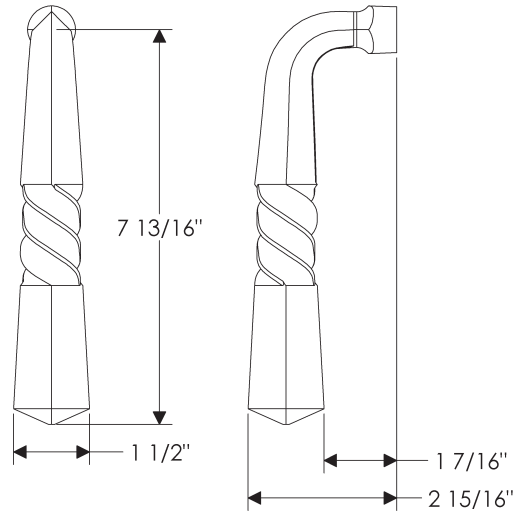

L146 Long Triple Twist Lever

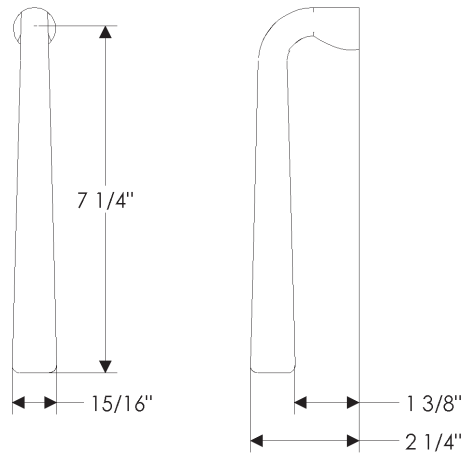
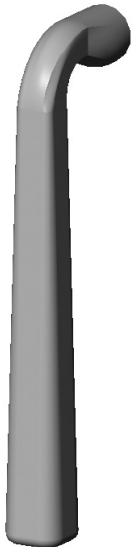

L148 Long French Lever

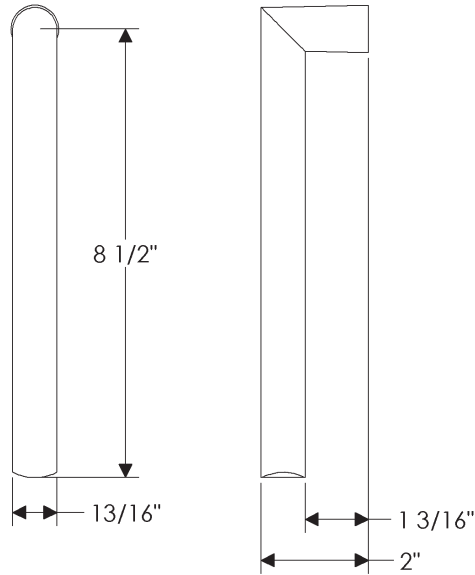
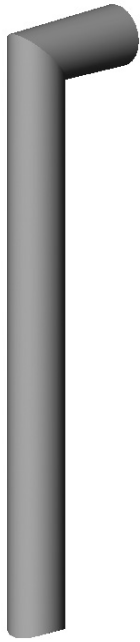

L149 Long Jane Lever

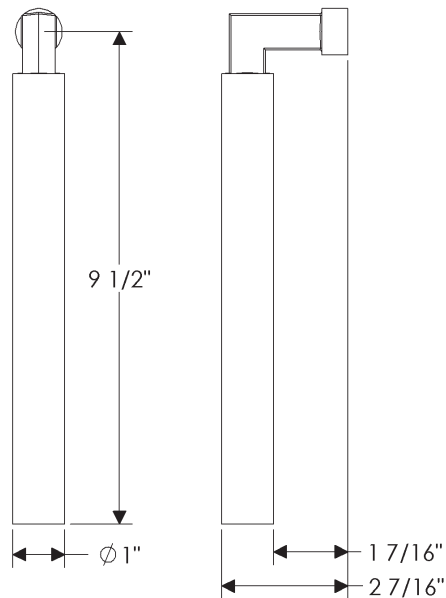
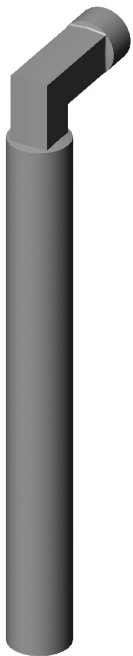

L157 Long Stalk Lever

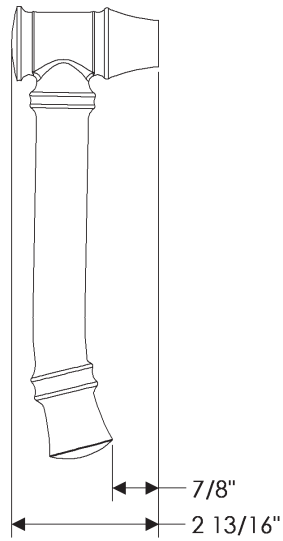
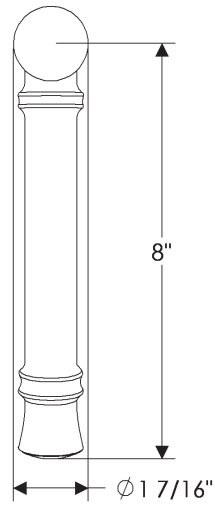
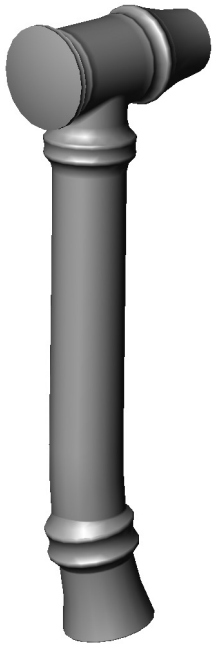

L167 Long Bamboo Lever

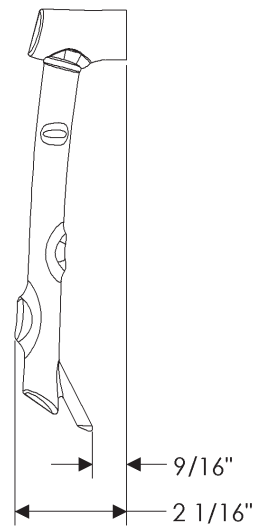
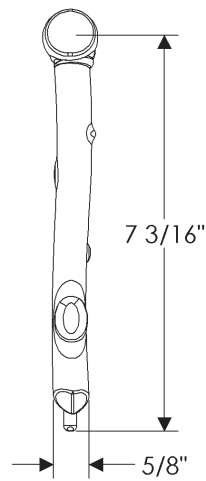
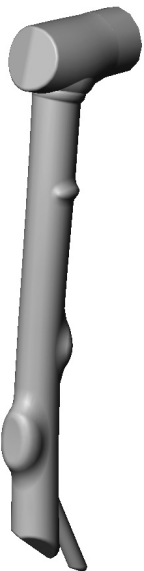

L168 Long Twig Lever

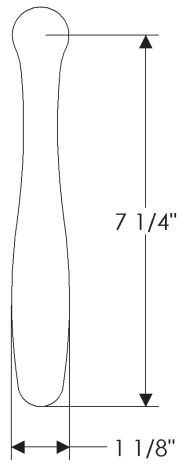

L172 Long Acanthus Lever

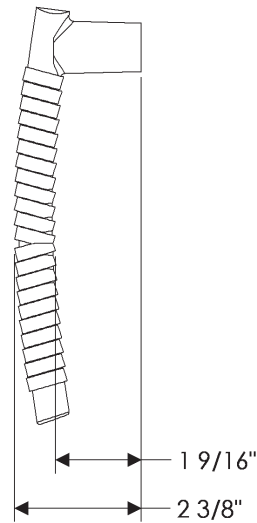
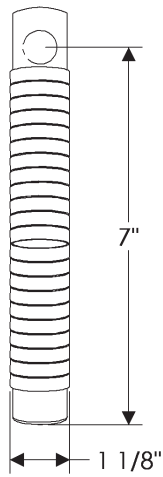
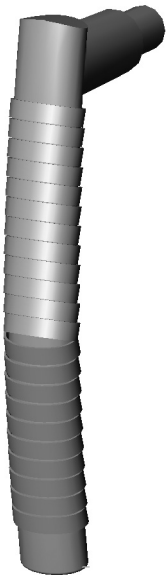

L173 Long Lariat Lever

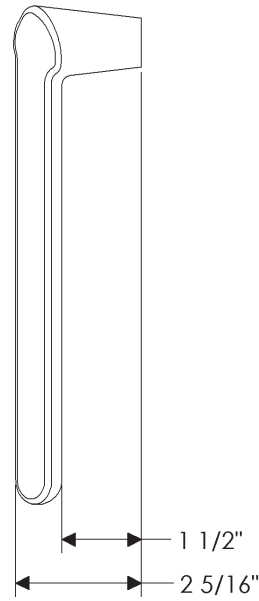
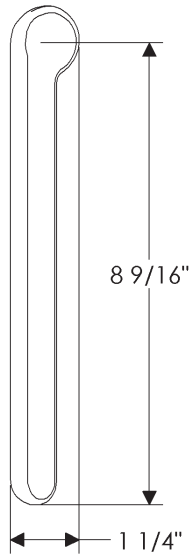
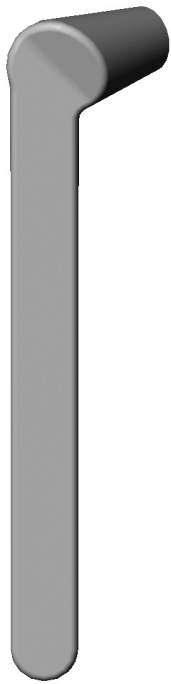

L176 Long Rock Creek Lever

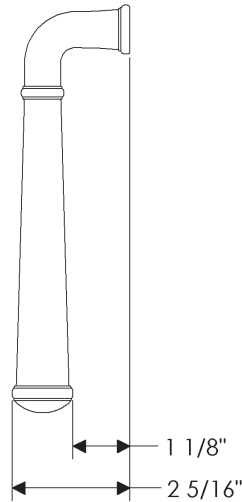
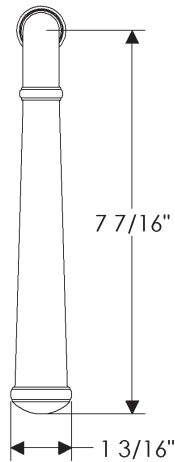
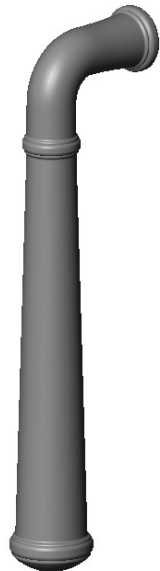

L180 Long Harrington Lever

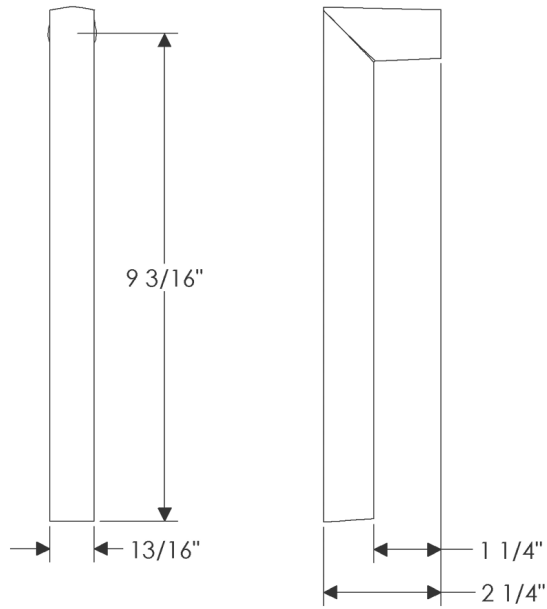
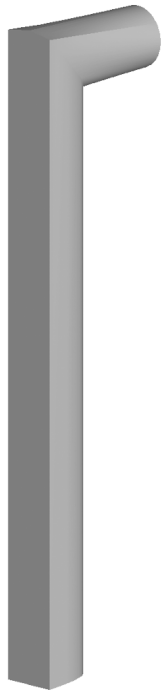

L263 Long Rail Lever

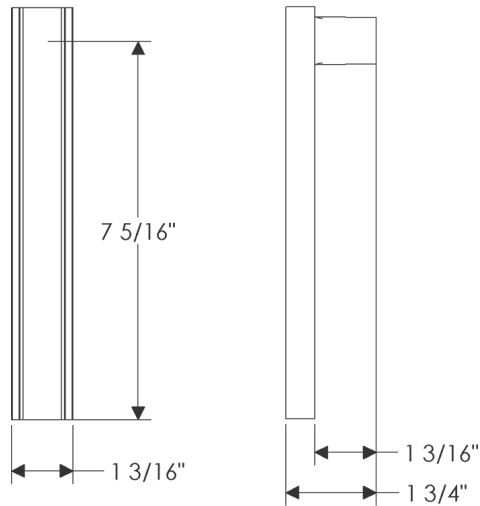
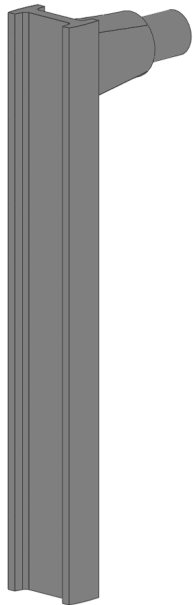

L266 Long I Beam Lever

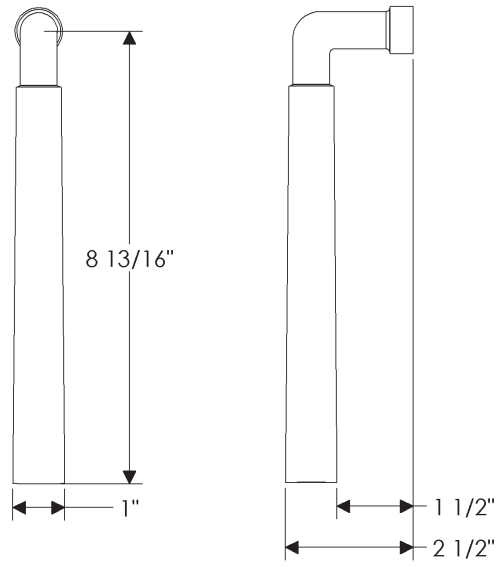
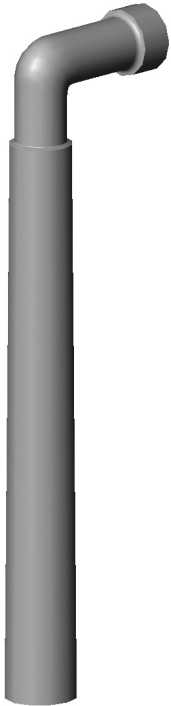

L331 Long Coupler Lever

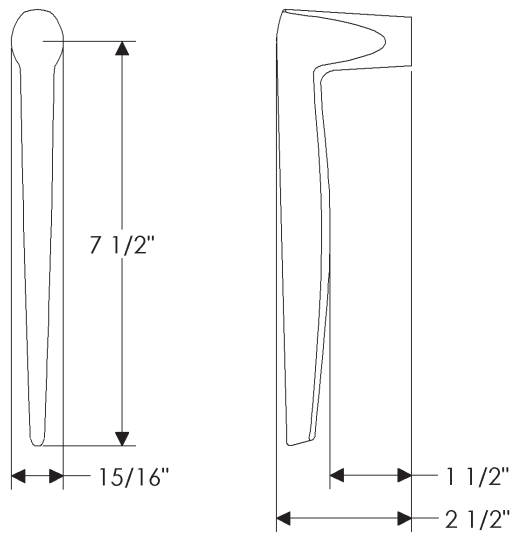
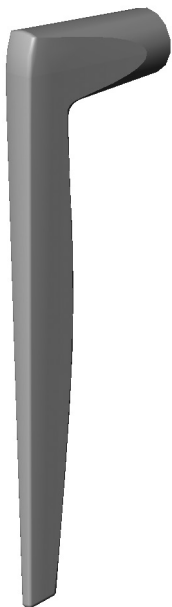

L332 Long Blade Lever

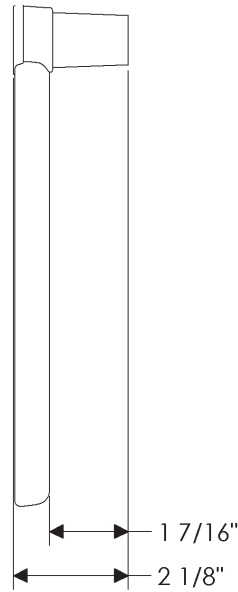
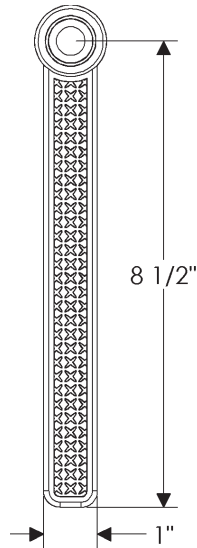
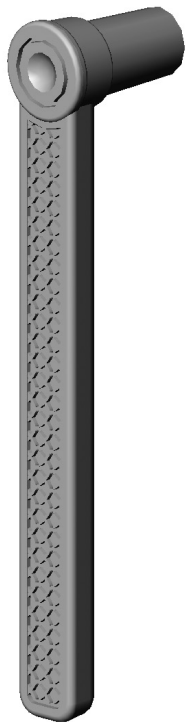

L10804 Long Briggs Lever

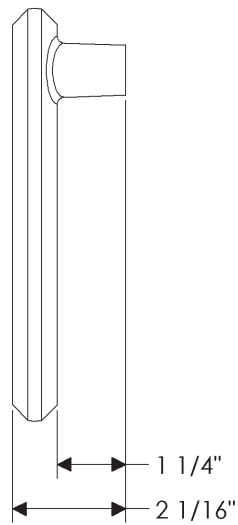
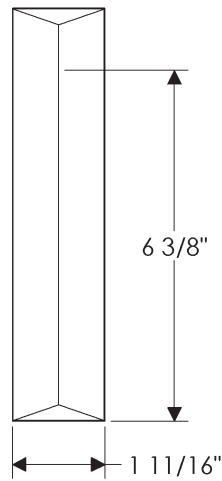
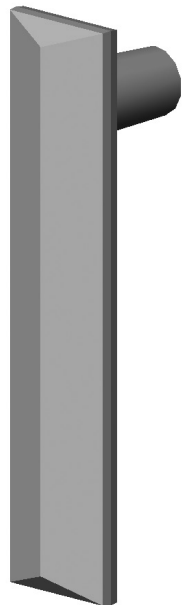

L21075 Long Emile Lever

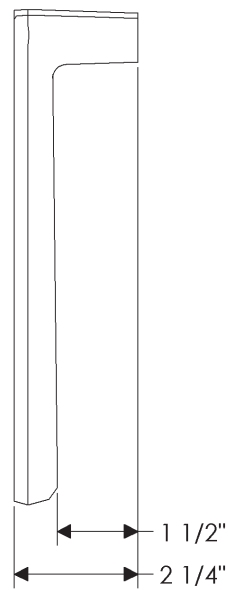
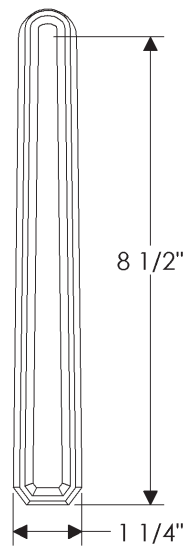
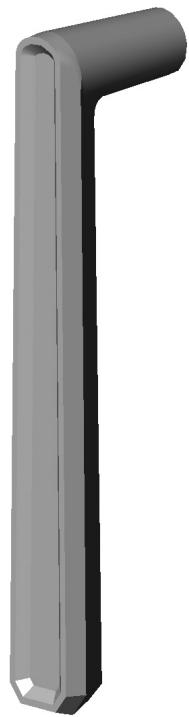

L30145 Long Smith Lever

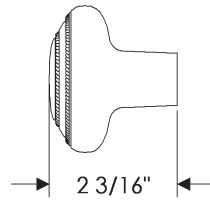
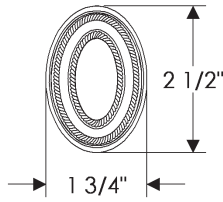

K075 Ellis Knob

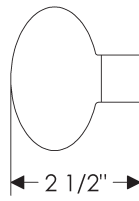
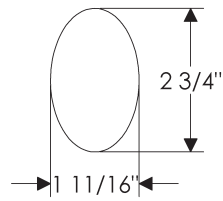
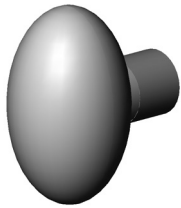

K150 Oval Crystal Knob
Upcharge applies for glass knob with any style of escutcheon. Call for pricing.

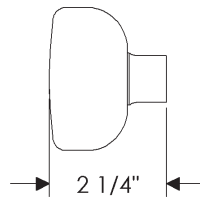
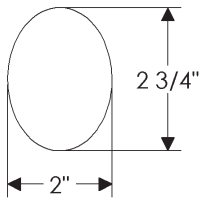
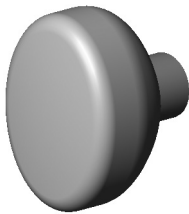

K151 Oval Cast Glass Knob
Upcharge applies for glass knob with any style of escutcheon. Call for pricing.

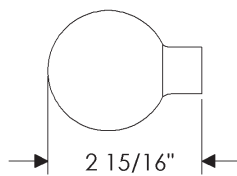
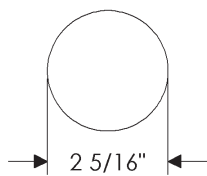
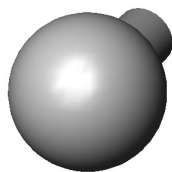

K155 Round Crystal Knob
Upcharge applies for glass knob with any style of escutcheon. Call for pricing.

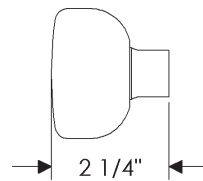
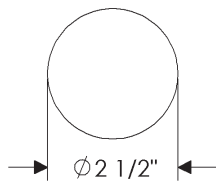

K156 Round Cast Glass Knob
Upcharge applies for glass knob with any style of escutcheon. Call for pricing.

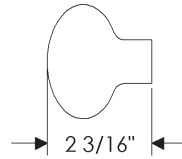
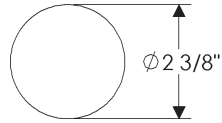
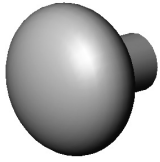

K200 Plymouth Knob

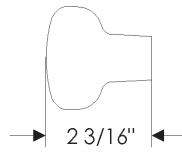
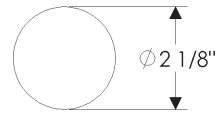

K201 Mushroom Knob

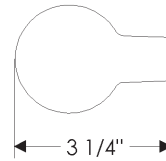
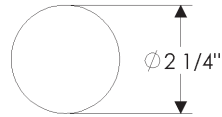
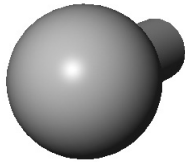

K202 Hitch Knob

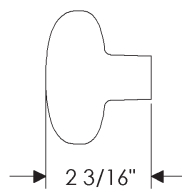
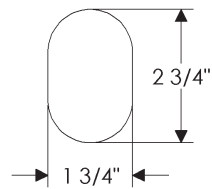
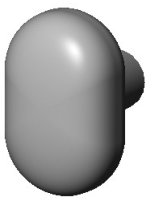

K203 Potato Knob

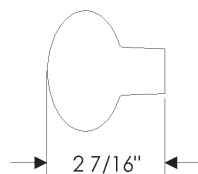
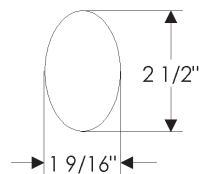
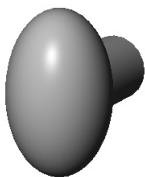

K204 Egg Knob

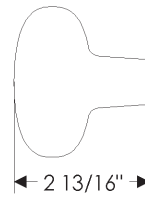
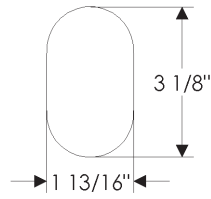
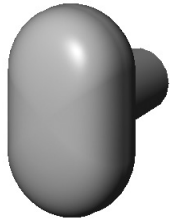

K205 Baker Knob

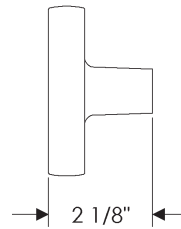
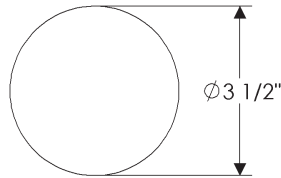
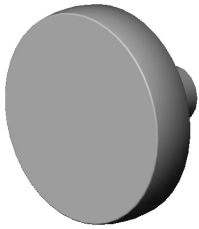

K206 Large Luna Knob

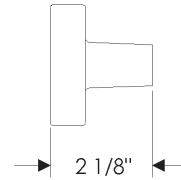
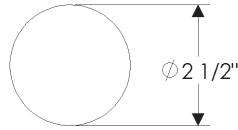

K207 Luna Knob

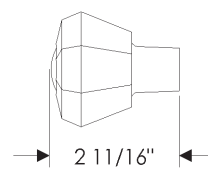
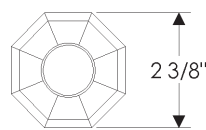
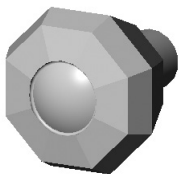

K208 Gem Knob

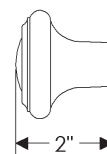
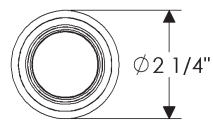

K209 Cottage Knob

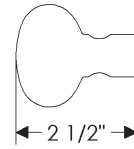
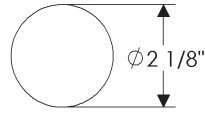
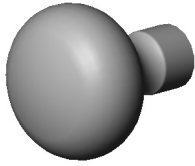

K210 Prairie Knob

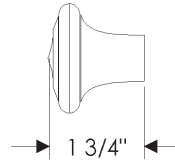

K211 Mini Roswell Knob
Also Available:
K251 Roswell Knob

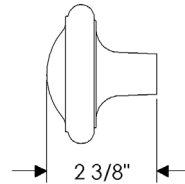
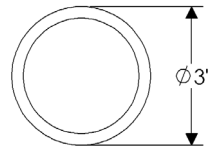

K215 Friedman Knob

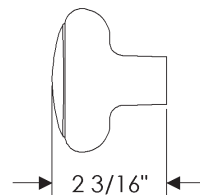
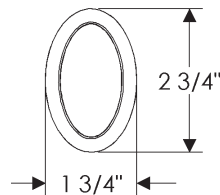

K218 Elliptic Knob

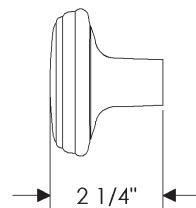
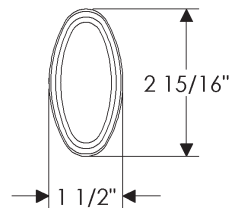

K219 Carriage Knob

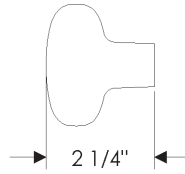
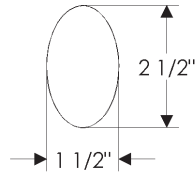

K230 Acanthus Knob
Also Available:
K233 Large Acanthus Knob

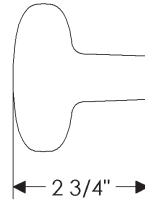
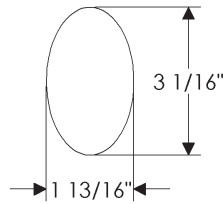

K233 Large Acanthus Knob
Also Available:
K230 Acanthus Knob

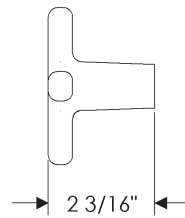
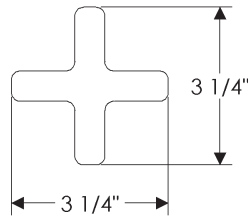

K235 Cross Knob

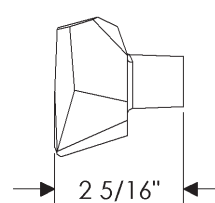
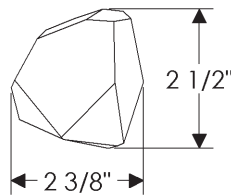
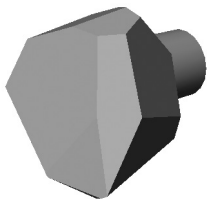

K236 Ore Knob

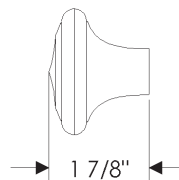

K251 Roswell Knob
Also Available:
K211 Mini Roswell Knob

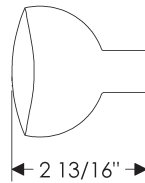
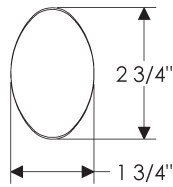
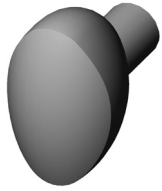

K268 Squash Knob

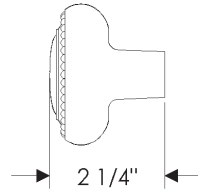
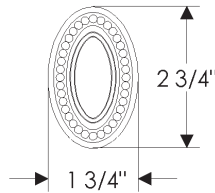
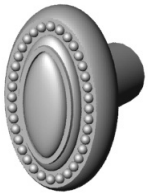

K580 Maddox Knob

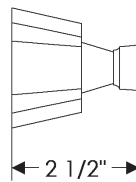
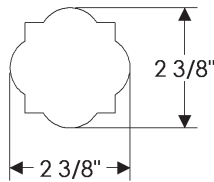
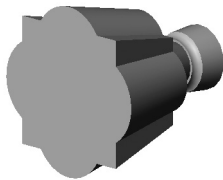

K10010 Quatrafoil Knob
Roger Thomas Collection

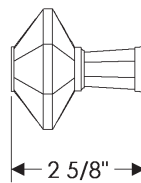
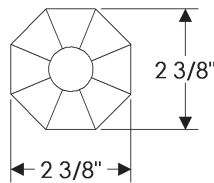
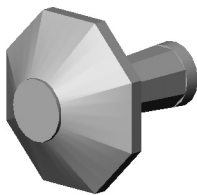

K10015 Octagonal Knob
Roger Thomas Collection

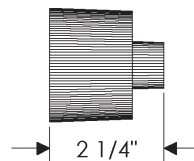
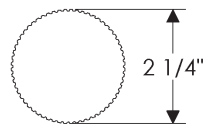
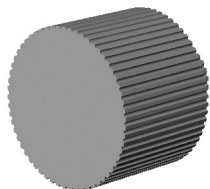

K10020 Flute Knob
Roger Thomas Collection

Not to be used with privacy
spring latch sets.

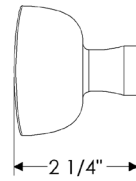
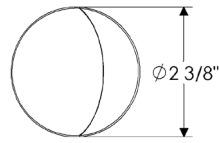
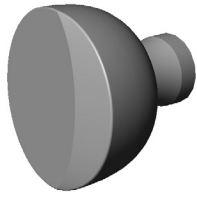

K10300 Flora Knob

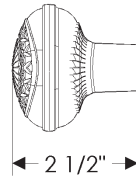
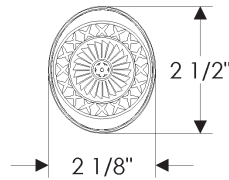

K10801 Sundial Knob

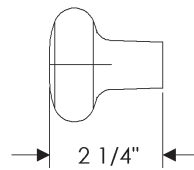
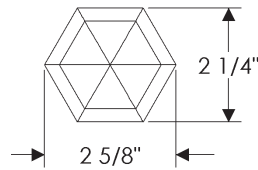
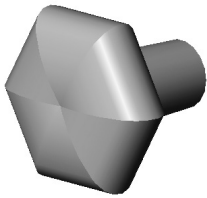

K10802 Kettle Knob

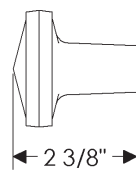
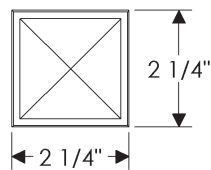
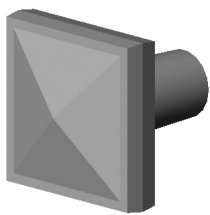

K21001 Mack Knob

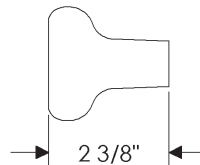
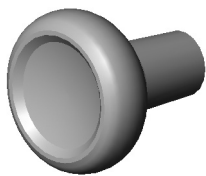

K30144 Smith Knob

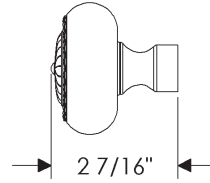
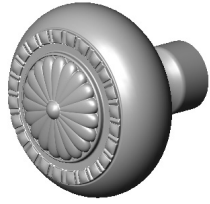

K30164 Crown Knob

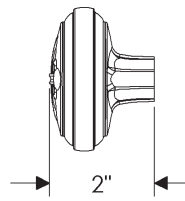
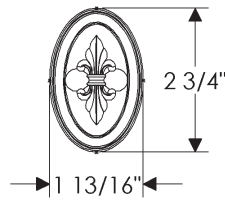

K30184 Cabernet Knob

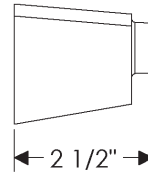
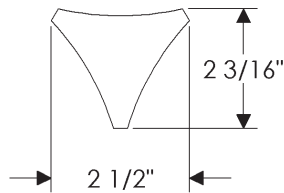
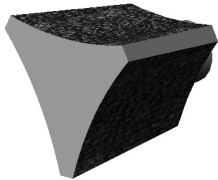

K30301 Trousdale Knob
Kravitz Design Collection

Not to be used with privacy spring latch sets.

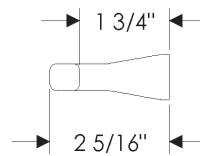
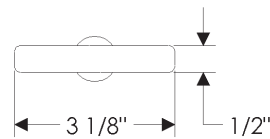

T300 T Handle

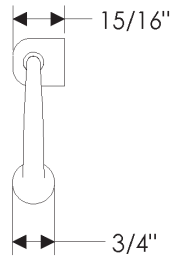
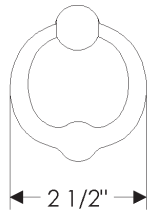
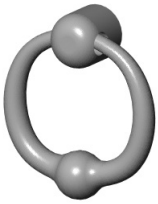

RP25 Ring Pull 2 1/2"

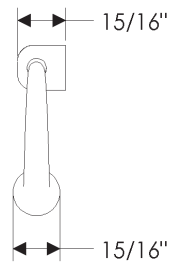
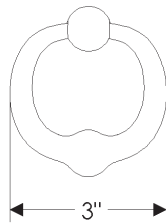
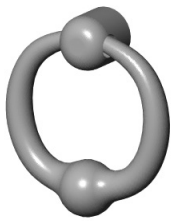

RP3 Ring Pull 3"

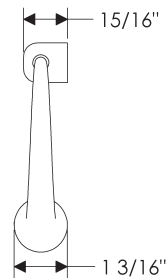
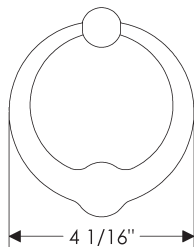
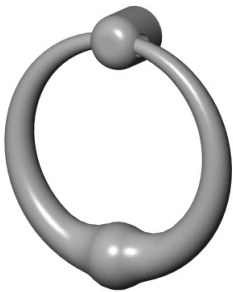

RP4 Ring Pull 4"