

Rectangular Flush Pull

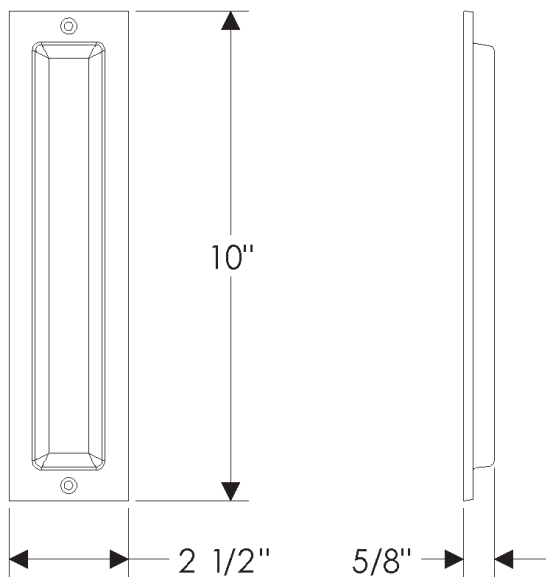

FP210