

Edge Multi-Point Set

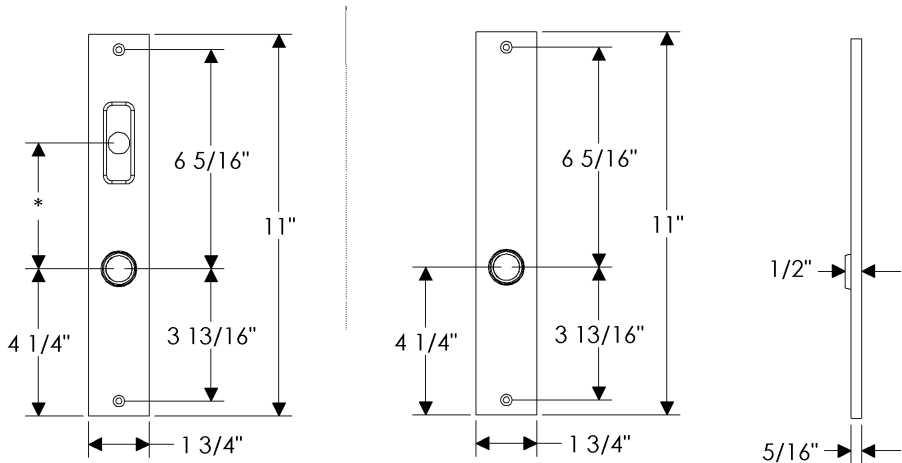

E193

E191

*Also applicable for the E192 with turnpiece.