

Rectangular Flush Pull

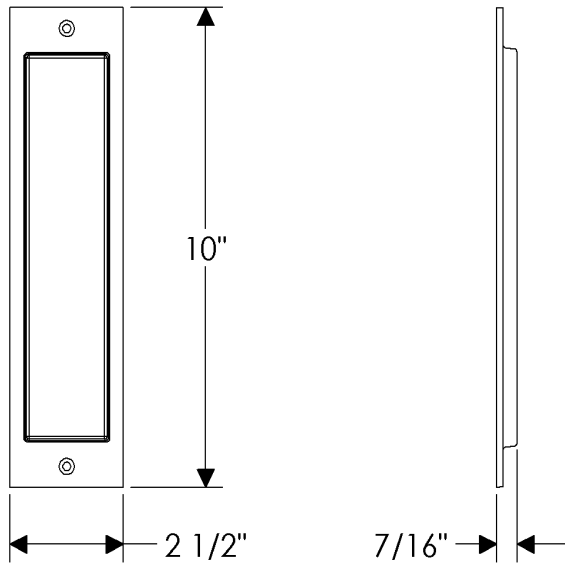

FP268