

Rectangular Flush Pull

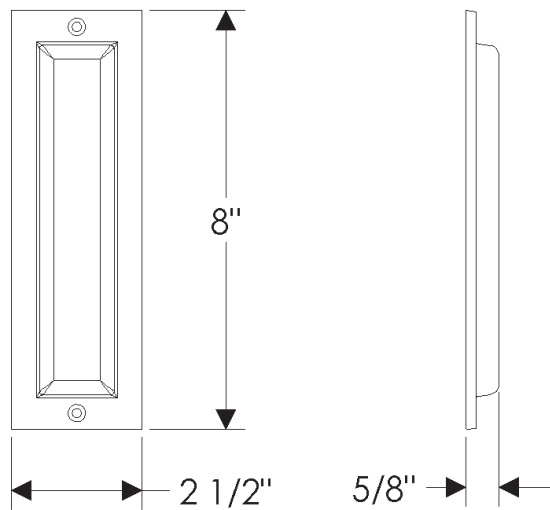

FP208